



H521-V
1 Mode Hand Shower Unit
Specification Submittal

Model Numbers	Feature Highlights
<input type="checkbox"/> H521-V <i>1 Mode Hand Shower Unit</i>	<ul style="list-style-type: none"> • 1 mode hand shower • 3" diameter hand shower head • In-line vacuum breaker for backflow protection • 30" slide bar with cradle for hand shower mounting • 60" flexible metal hose • Standard 2.5 gpm (9.5 L/min) flow restrictor • Shall be metal and nonmetallic construction, plated in standard polished chrome finish
Options/Modifications	
<input type="checkbox"/> -1.5  <i>1.5 gpm (5.7 L/min) flow restrictor</i> <input type="checkbox"/> -2.0 <i>2.0 gpm (7.6 L/min) flow restrictor</i> <input type="checkbox"/> -STN <i>Satin Nickel finish</i> Note: Append appropriate -suffix to model number.	
Compliance	Warranty
- ASME A112.18.1/CSA B125.1 	Limited Lifetime - to the original end purchaser in consumer installations. 5 Years - for commercial installations. Refer to www.symmons.com/warranty for complete warranty information.

Dimensions

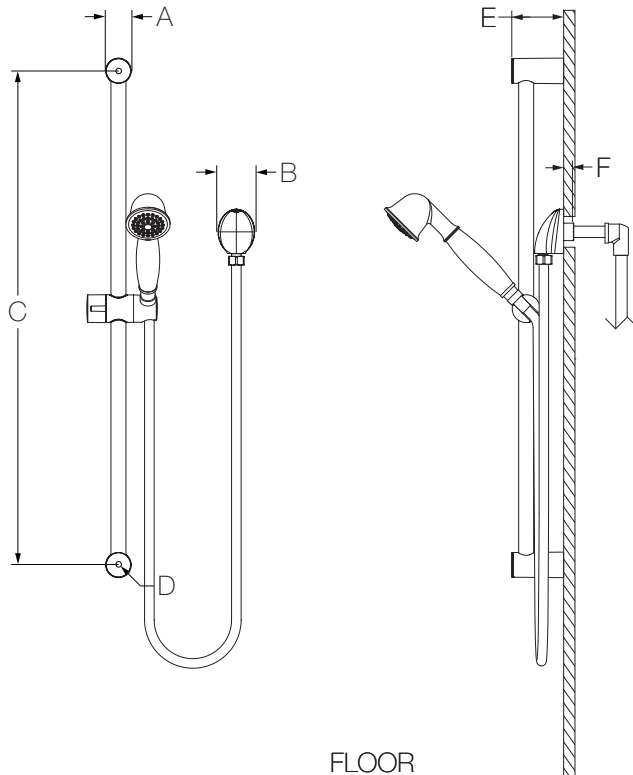

Measurements	
A	Ø 1-1/2", 38 mm
B	2-1/8", 54 mm
C	28-9/16", 725 mm
D	(2x) Hole Size: Ø 1/4", 6 mm
E	3", 76 mm
F	Male 1/2-14 NPT fitting must be recessed 1/4" (6 mm) from finished wall

Note: Dimensions subject to change without notice.