



Location:

SYMMONS® Origins®

the smart choice™

9601-P, 9601-P-TRM, 9601PTRMTC
Shower Trim
Specification Submittal



Feature Highlights

- Origins Shower System or Trim
- Requires Temptrol® Pressure Balancing Shower Valve (included with 9601-P)
- Adjustable stop screw to limit handle turn (included with 9601-P)
- Tri-star handle
- 1 mode showerhead with easy to clean nozzles
- 2.5 gpm (9.5 L/min) flow restrictor
- Tub spout not included
- Components shall be metal and nonmetallic construction, plated in standard Polished Chrome finish
- Available with TA-10 flow control spindle and T-12A cap assembly for Temptrol valve bodies installed with Test Cap (order p/n 9601PTRMTC)

Model Numbers

- 9601-P**
Shower Trim with Temptrol Pressure Balancing Shower Valve
- 9601-P-TRM**
Shower Trim, Temptrol Pressure Balancing Shower Valve ordered separately
- 9601PTRMTC**
Shower Trim with TA-10 flow control spindle and T-12A cap assembly, must order Temptrol valve with Test Cap

Compliance







- ASME A112.18.1/CSA B125.1
- WaterSense @ 2.0 gpm/1.75 gpm/1.5 gpm
- Buy American Act (9601-P only)



Warranty

Limited Lifetime - to the original end purchaser in consumer/residential installations.
5 Years - for industrial/commercial installations.
 Refer to www.symmons.com/warranty for complete warranty information.
 Go to www.symmons.com/register to register your Symmons product.

Options/Modifications

- 1.2**  1.2 gpm (4.5 L/min) flow restrictor
- 1.5**  1.5 gpm (5.7 L/min) flow restrictor
- 1.75**  1.75 gpm (6.6 L/min) flow restrictor
- 2.0** 2.0 gpm (7.6 L/min) flow restrictor
- 143** 3 mode showerhead
- 145** 5 mode showerhead
- 151** 1 mode showerhead
- 231** Super showerhead
- 295** Institutional showerhead
- B** Brass escutcheon (chrome only)
- CHKS** Integral check stops - for use in installations where a positive shut-off device is used downstream of mixing valve
- D** Brass dome cover (chrome only)
- L1** Less showerhead
- LAM**  Metal finish insert handle
- LP**  Loop handle
- REB**  Rebuild trim kit, includes TA-10 and TA-4
- VP** Vandal resistant escutcheon screws in place of standard screws
- X** Integral service stops - allows water shut off at valve for service

Note: Append appropriate -suffix to model number.

Dimensions

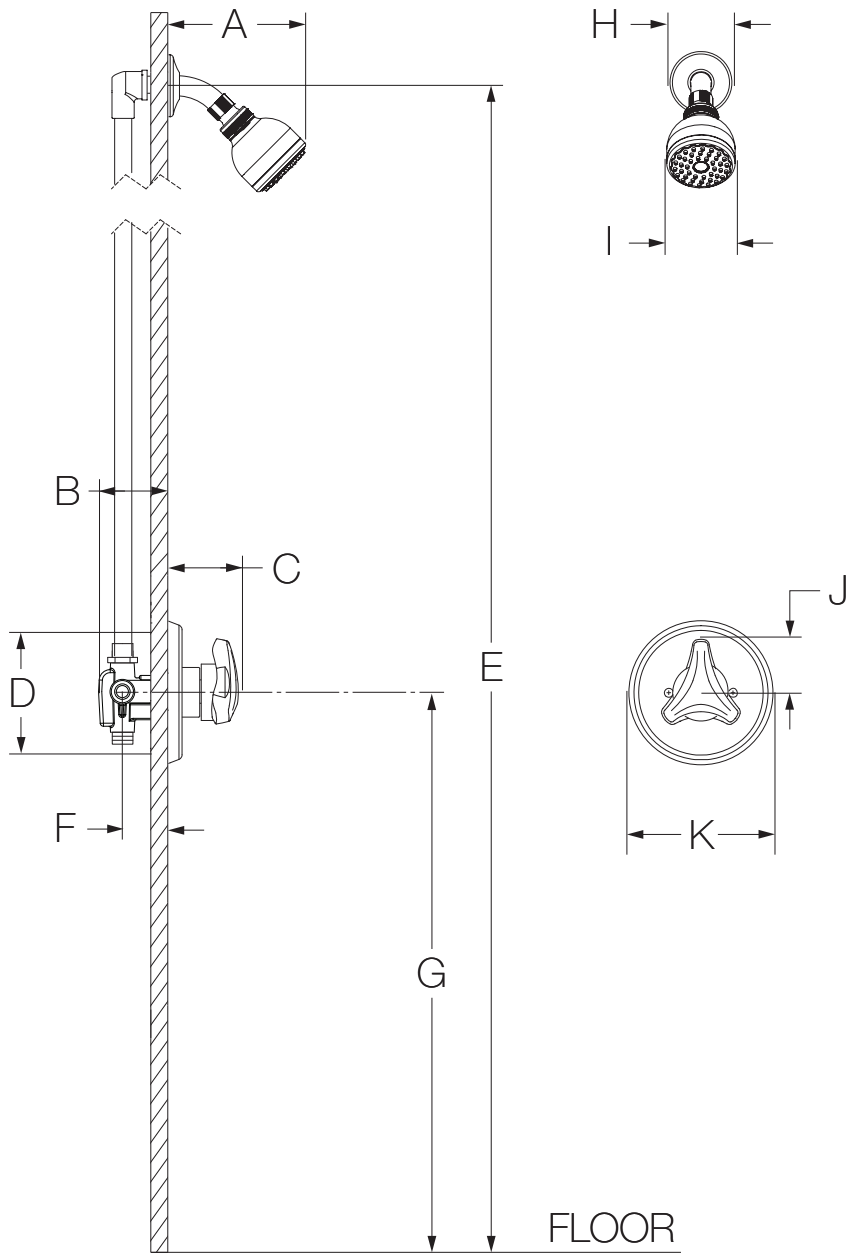

Measurements	
A	6-3/8", 162 mm
B	3-1/2", 89 mm
C	2-7/8", 73 mm
D	Shower Valve Hole Size Min. Ø 3", 76 mm Max. Ø 4", 102 mm
E	Ref. 77", 1956 mm
F	Rough-in 2-3/8" ± 1/2", 60 mm ± 13 mm
G	Ref. 42", 1067 mm
H	Ø 2-1/2", 64 mm
I	Ø 2-3/4", 70 mm
J	2-1/8", 54 mm
K	Ø 5-3/4", 146 mm

Notes:

- 1) Valve body and piping not included and shown as reference only.
- 2) Plaster shield (p/n T-176) for dry wall, plaster or other type walls 1/2" or greater.
- 3) All dimensions measured from nominal rough-in (see F as reference).
- 4) Dimensions subject to change without notice.