









Location:



6702  
Tub/Shower System  
**Specification Submittal**

**Identity™**

Model Numbers	Specification
<input type="checkbox"/> <b>6702</b> <i>Identity Tub/Shower System</i>	<p>Tub/shower system powered by the Temptrol® pressure-balancing valve. Features adjustable stop screw to limit handle turn, diverter tub spout, 1 mode showerhead with easy to clean rubber nozzles and standard 2.5 gpm (9.5 L/min) flow restrictor. Components made from metal and nonmetallic materials, plated in standard polished chrome finish.</p> <div style="text-align: right;">   </div>
<p><b>Modifications</b></p> <ul style="list-style-type: none"> <li><input type="checkbox"/> <b>-1.5</b>  1.5 gpm (5.7 L/min) flow restrictor</li> <li><input type="checkbox"/> <b>-2.0</b>  2.0 gpm (7.6 L/min) flow restrictor</li> <li><input type="checkbox"/> <b>-143</b> 3 mode showerhead</li> <li><input type="checkbox"/> <b>-145</b> 5 mode showerhead</li> <li><input type="checkbox"/> <b>-231</b> 2 mode showerhead</li> <li><input type="checkbox"/> <b>-CHKS</b> Integral check stops - for use in installations where a positive shut-off device is used downstream of mixing valve</li> <li><input type="checkbox"/> <b>-IPS</b> 1/2" female IPS connections</li> <li><input type="checkbox"/> <b>-L/HD</b> Less showerhead</li> <li><input type="checkbox"/> <b>-LP</b> Loop handle</li> <li><input type="checkbox"/> <b>-LR</b> Lever handle</li> <li><input type="checkbox"/> <b>-OP</b> 13" oval plate</li> <li><input type="checkbox"/> <b>-REB-TRM</b> Rebuild trim kit</li> <li><input type="checkbox"/> <b>-REV</b> Reverse coring, hot on right, cold on left, for back to back installations</li> <li><input type="checkbox"/> <b>-SS</b> Slip spout on any tub/shower unit</li> <li><input type="checkbox"/> <b>-STN</b> Satin Nickel finish</li> <li><input type="checkbox"/> <b>-TRM</b> Trim only, valve not included</li> <li><input type="checkbox"/> <b>-X</b> Integral service stops - allows water shutoff at valve for service</li> </ul> <p><b>Note:</b> Append appropriate -suffix to model number.</p>	
<b>Compliance</b>	
<p>-ASME A112.18.1/CSA B125.1          -WaterSense 1.5 gpm (5.7 L/min)          2.0 gpm (7.6 L/min)</p> <div style="text-align: right;">   </div>	
<b>Warranty</b>	
<p><b>Limited Lifetime</b> - to the original end purchaser in consumer/residential installations.  <b>5 Years</b> - for industrial/commercial installations.          Refer to <a href="http://www.symmons.com/warranty">www.symmons.com/warranty</a> for complete warranty information.</p>	

## Dimensions

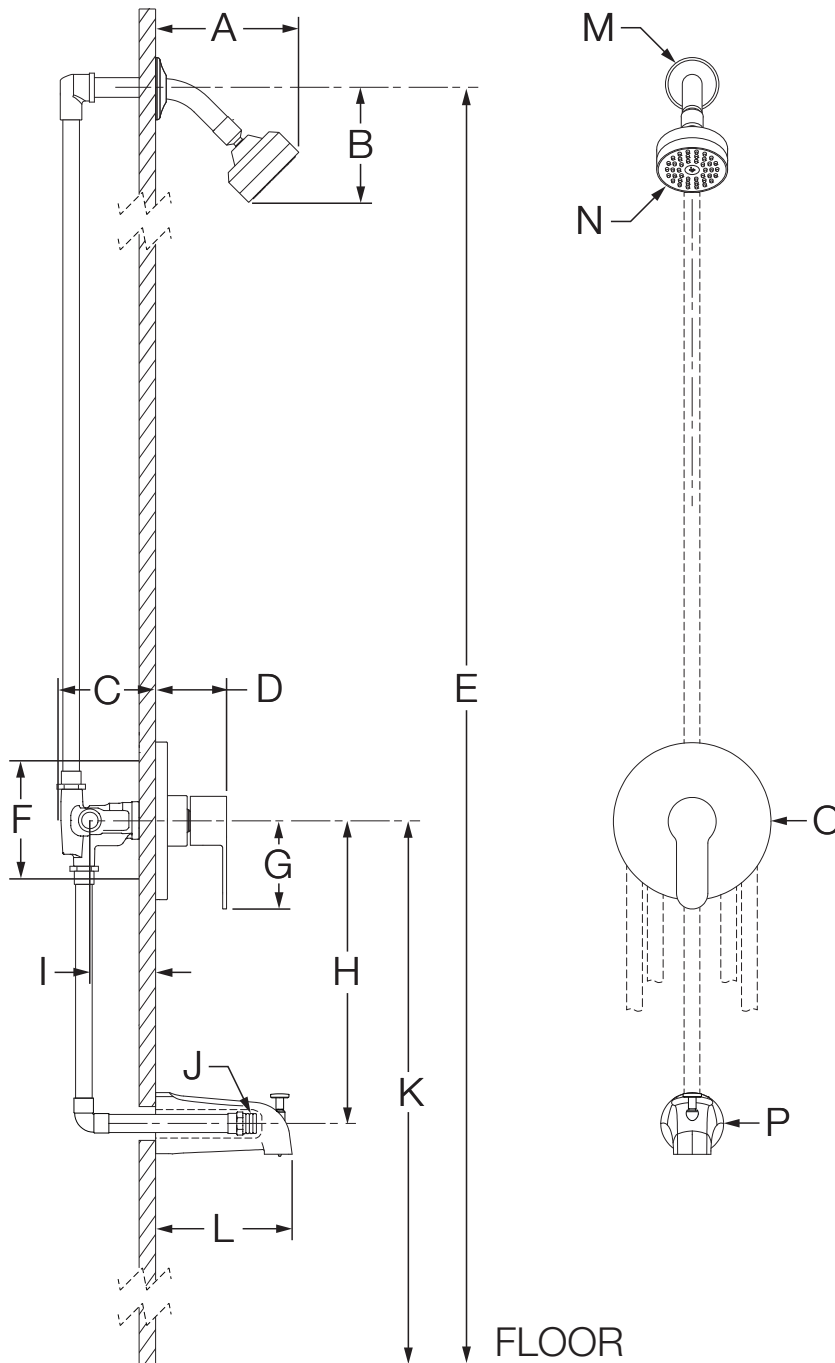

Measurements	
A	5-7/8", 149 mm
B	4-5/8", 117 mm
C	3-1/2", 89 mm
D	2-7/8", 73 mm
E	Ref. 77", 1956 mm
F	Shower Valve Hole Size Min. Ø 3", 76 mm Max. Ø 4", 102 mm
G	3-1/2", 89 mm
H	12", 305 mm
I	Rough-in 2-3/8" ± 1/2", 60 mm ± 13 mm
J	Male 1/2" NPT fitting must protrude 4" (102 mm) from finished wall
K	Ref. 32", 813 mm
L	5-1/4", 133 mm
M	Ø 2-1/2", 64 mm
N	Ø 3-1/8", 79 mm
O	Ø 6-3/8", 162 mm
P	Ø 2-1/2", 64 mm

### Notes:







- 1) All dimensions measured from nominal rough-in (see I as reference).
- 2) Dimensions subject to change without notice.



6702

Système de baignoire-douche

## Présentation des spécifications

Numéros de modèle	Spécifications
<input type="checkbox"/> <b>6702</b> <i>Système de baignoire/douche Identity</i>	<p>Système de baignoire-douche alimenté par la vanne à pression autorégularisée Temptrol®. Comprend une vis d'arrêt réglable pour limiter la rotation de la poignée, bec de baignoire à dérivation, une pomme de douche à mode unique avec des embouts en caoutchouc faciles à nettoyer et un réducteur de débit de 2,5 gpm (9,5 L/min) standard. Les composants sont faits de matériaux métalliques et non métalliques au fini chrome poli standard.</p>  
<p><b>Modifications</b></p>	
<input type="checkbox"/> <b>-1.5</b>  Réducteur de débit de 1,5 gpm (5,7 L/min)	
<input type="checkbox"/> <b>-2.0</b>  Réducteur de débit de 2,0 gpm (7,6 L/min)	
<input type="checkbox"/> <b>-143</b> <i>Pomme de douche à 3 modes</i>	
<input type="checkbox"/> <b>-145</b> <i>Pomme de douche à 5 modes</i>	
<input type="checkbox"/> <b>-231</b> <i>Pomme de douche à 2 modes</i>	
<input type="checkbox"/> <b>-CHKS</b> <i>Valve d'arrêt intégrée - pour une utilisation dans les installations où un dispositif de coupure intégrale est utilisé en aval de la vanne de mélange.</i>	<p><b>Conformité</b></p> <p>-ASME A112.18.1/CSA B125.1          -WaterSense 1,5 gpm (5,7 L/min)          2,0 gpm (7,6 L/min)</p>  
<input type="checkbox"/> <b>-IPS</b> <i>Raccords IPS femelles de 1/2 po</i>	
<input type="checkbox"/> <b>-L/HD</b> <i>Sans pomme de douche</i>	
<input type="checkbox"/> <b>-LP</b> <i>Poignée en boucle</i>	
<input type="checkbox"/> <b>-LR</b> <i>Poignée à levier</i>	
<input type="checkbox"/> <b>-OP</b> <i>Plaque ovale de 13 po</i>	
<input type="checkbox"/> <b>-REB-TRM</b> <i>Restaurez la trousse de finition</i>	
<input type="checkbox"/> <b>-REV</b> <i>Corps central inversé, l'eau chaude à la droite, l'eau froide à la gauche, pour installations dos à dos</i>	
<input type="checkbox"/> <b>-SS</b> <i>Bec de baignoire à enfiler sur toute unité de baignoire-douche</i>	
<input type="checkbox"/> <b>-STN</b> <i>Fini nickel satiné</i>	
<input type="checkbox"/> <b>-TRM</b> <i>Garniture seulement, vanne non incluse</i>	
<input type="checkbox"/> <b>-X</b> <i>Robinet d'interruption du service - permet la coupure de l'eau à la vanne pour le service</i>	
<p><b>Remarque :</b> Juxtaposer le -suffixe approprié au numéro de modèle.</p>	<p><b>Garantie</b></p> <p><b>À vie limitée</b> - à l'acheteur final original dans les installations chez le client/résidentiel.  <b>5 ans</b> – pour des installations commerciales et industrielles.          Se reporter au site <a href="http://www.symmons.com/warranty">www.symmons.com/warranty</a> pour des informations complètes concernant la garantie.</p>

## Dimensions

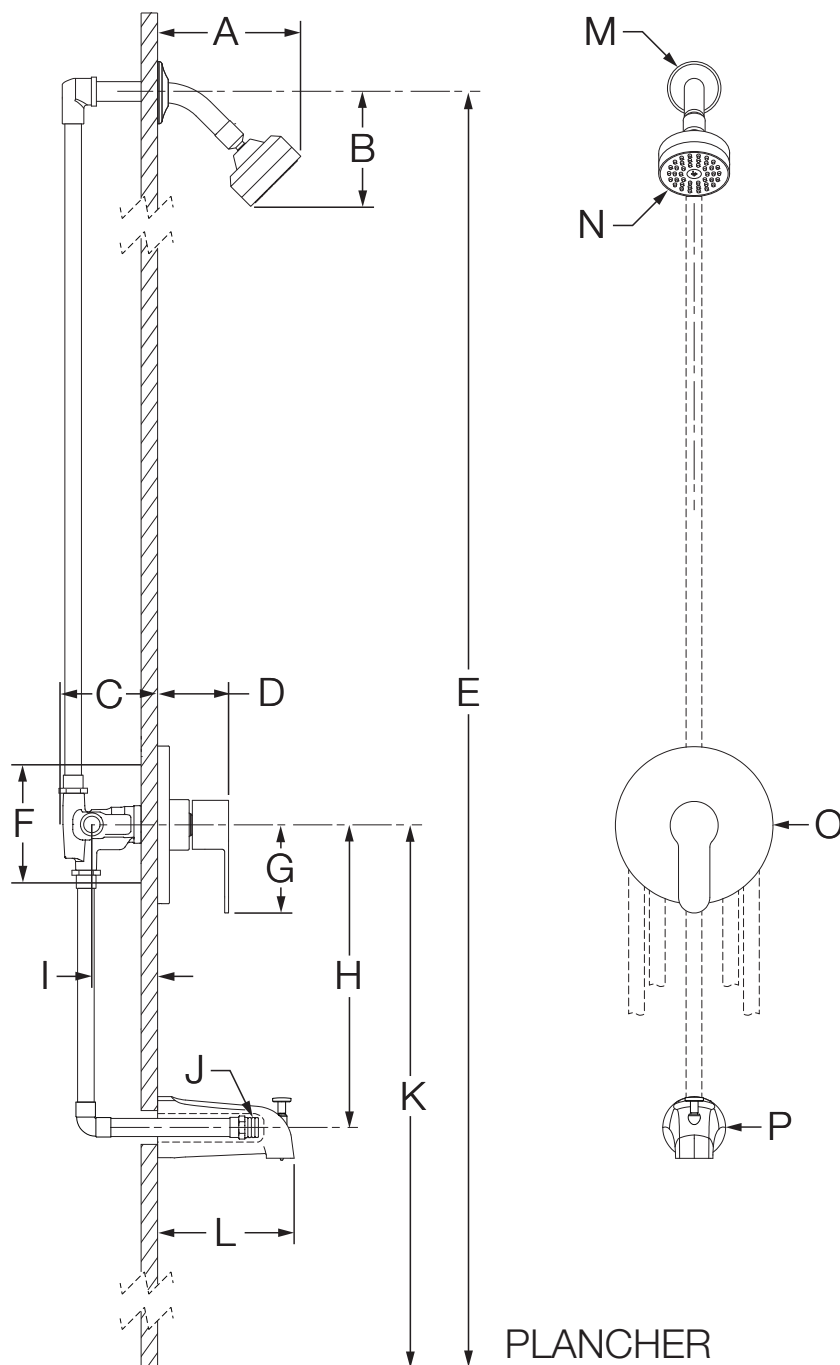

Mesures	
A	5-7/8 po, 149 mm
B	4-5/8 po, 117 mm
C	3-1/2 po, 89 mm
D	2-7/8 po, 73 mm
E	Réf. 77 po, 1956 mm
F	Taille du trou pour la vanne de douche Min. Ø 3 po, 76 mm Max. Ø 4 po, 102 mm
G	3-1/2 po, 89 mm
H	12 po, 305 mm
I	Robinetterie brute 2-3/8 po ± 1/2 po, 60 mm ± 13 mm
J	Raccord NPT 1/2 po mâle doit faire saillie de 4 po (102 mm) du mur fini
K	Réf. 32 po, 813 mm
L	5-1/4 po, 133 mm
M	Ø 2-1/2 po, 64 mm
N	Ø 3-1/8 po, 79 mm
O	Ø 6-3/8 po, 162 mm
P	Ø 2-1/2 po, 64 mm

### Remarques :

- 1) Toutes les dimensions sont mesurées à partir de la robinetterie brute nominale (voir I en référence).
- 2) Les dimensions sont sujettes à changer sans préavis.