



# SYMMONS® Degas®

the smart choice™

## Degas Trim Series

### Degas Trim Series with TA-10 Flow Control Spindle & T-12A Cap Assembly Installation & Operation Instructions

#### Model Numbers

##### TRIM ONLY

##### **S-5400-TRM**

Shower Valve Trim

##### **S-5401-TRM**

Shower Trim

##### **S-5402-TRM**

Tub/Shower Trim

##### **S-5404-TRM**

Tub/Hand Shower Trim

##### **S5408TRM**

Shower/Hand Shower Trim

##### TRIM, TA-10, T-12A

##### **S5400TRMTC**

Shower Valve Trim

##### **S5401TRMTC**

Shower Trim

##### **S5402TRMTC**

Tub/Shower Trim

##### **S5404TRMTC**

Tub/Hand Shower Trim

##### **S5408TRMTC**

Shower/Hand Shower Trim

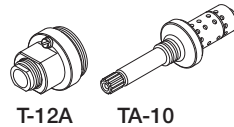

T-12A

TA-10

#### Compliance

- ASME A112.18.1/CSA B125.1



#### Warranty

**Limited Lifetime** - to the original end purchaser in consumer/residential installations.

**5 Years** - for industrial/commercial installations.

Refer to [www.symmons.com/warranty](http://www.symmons.com/warranty) for complete warranty information.

Go to [www.symmons.com/register](http://www.symmons.com/register) to register your Symmons product.



S-5400-TRM  
S5400TRMTC



S-5401-TRM  
S5401TRMTC

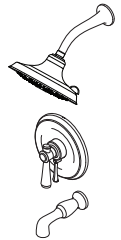

S-5402-TRM  
S5402TRMTC

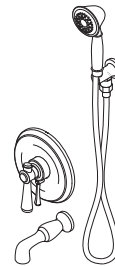

S-5404-TRM  
S5404TRMTC

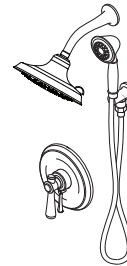

S5408TRM  
S5408TRMTC

## 1. Recommended Tools

FIGURE 1

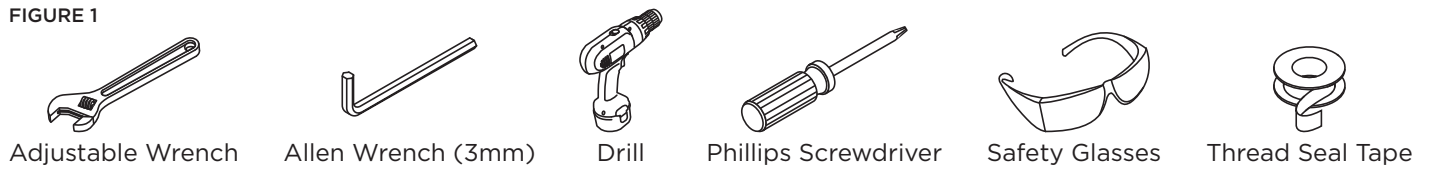

## 2. Dimensions

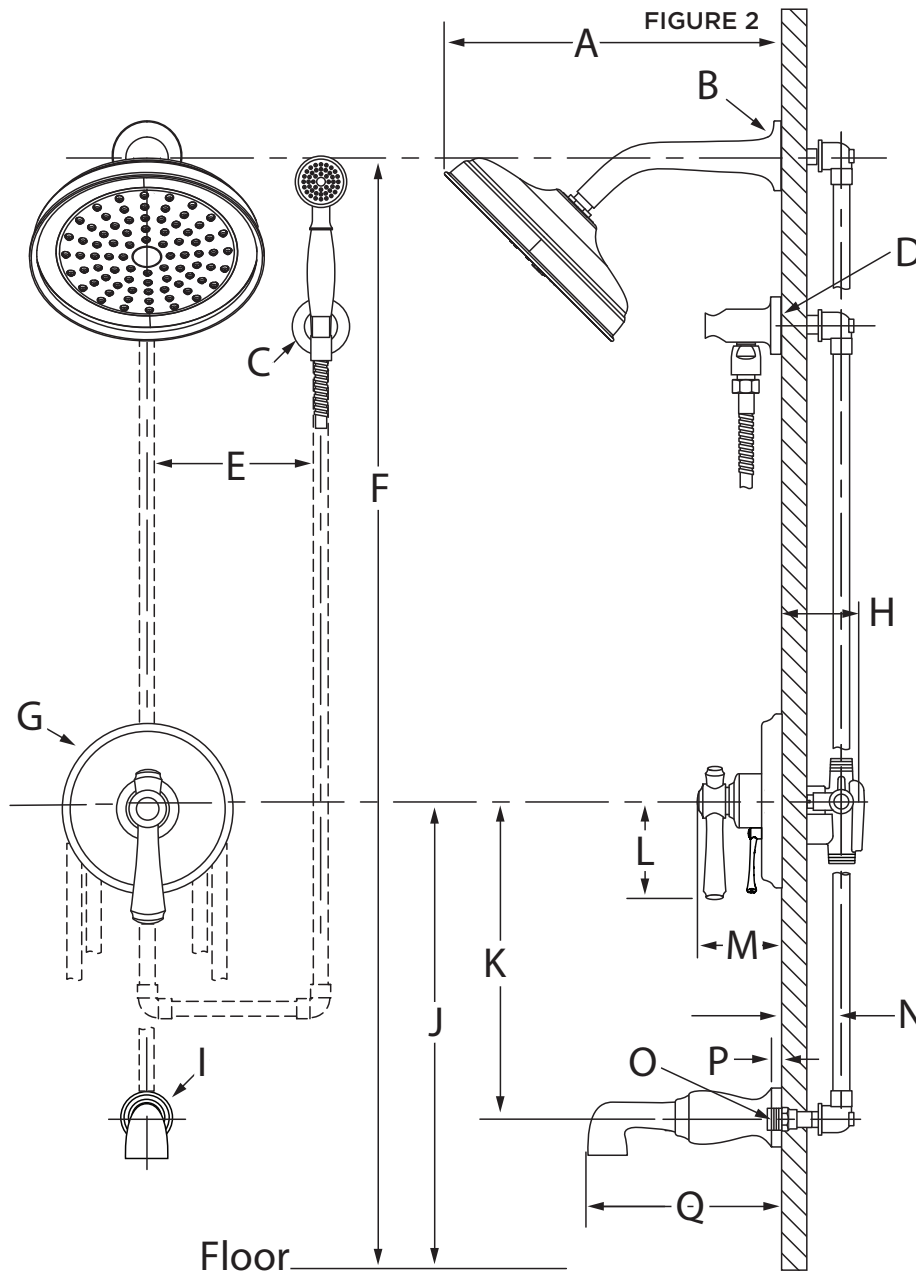

Measurements

A	12-1/8", 308 mm
B	Ø 2-1/2", 64 mm
C	Ø 2-1/2", 64 mm
D	Male 1/2" IPS thread must protrude 3/8" from finished wall
E	6", 152 mm
F	Ref. 77", 1956 mm
G	Ø 7", 178 mm
H	3-1/2", 89 mm
I	Ø 2-1/2", 64 mm
J	<b>Trim with tub spout:</b> Ref. 32", 813 mm <b>Trim without tub spout:</b> Ref. 42", 1067 mm
K	12", 305 mm
L	3-3/4", 95 mm
M	4-1/4", 108 mm
N	(Rough in) 2-3/8" ± 1/2", 60 mm ± 13 mm
O	1/2" - 14 NPT
P	1/2", 13 mm
Q	8", 203 mm

### Notes:

- 1) Valve body and piping not included and shown as reference only.
- 2) Plaster shield (p/n T-176) for dry wall, plaster or other type walls 1/2" or greater.
- 3) All dimensions measured from nominal rough-in (see N as reference).
- 4) Dimensions subject to change without notice.

### 3. Parts Breakdown (Model Numbers Ending in TRMTC)

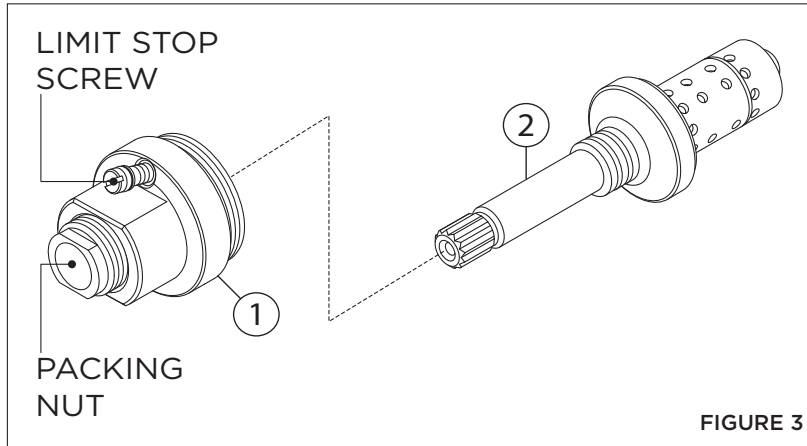

FIGURE 3

Replacement Parts		
Item	Description	Part Number
1	Cap Assy.	T-12A
2	Flow Control Spindle	TA-10

**IMPORTANT:** Model numbers ending in **TRMTC** coordinate with Temptrol pressure balancing valves ordered with Test Cap. The Test Cap is used to allow pressurization of system. **Do not** remove test cap from valve during wall construction, installation of valve or pressurization of system.

**⚠ WARNINGS:**

1. Test cap rated for pressure testing up to 200 psi maximum. **DO NOT** exceed 200 psi while pressure testing valve body.
2. Do not expose valve with test cap to heat for longer than 2 minutes when soldering copper tubing. Doing so may damage the internal components of the valve and will void the product warranty.
3. Ensure test cap is re-torqued to **30 lb-ft** after soldering valve body.

### 4. Installation - Remove Test Cap (Model Numbers Ending in TRMTC)

Flow control spindle (TA-10) and cap assembly (T-12A) will come factory assembled for all model numbers ending in **TRMTC**. When ready to remove Test Cap and install trim, follow the instructions below:

- 1) Check for leaks around the valve assembly and all pipe fittings.
- 2) Remove test cap from valve (FIGURE 4.1).
- 3) If system is dirty, flush valve.
- 4) Thread flow control spindle and cap assembly into valve body. Turn clockwise to secure to valve (FIGURE 4.2).

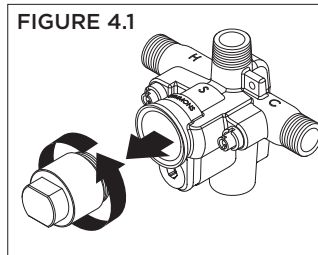

FIGURE 4.1

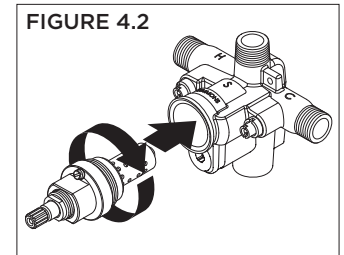

FIGURE 4.2

### 5. Installation - Adjust Packing Nut (Model Numbers Ending in TRMTC)

- 1) Turn hot and cold supplies on. Valve will not operate unless both hot and cold water supply pressures are on.
- 2) Place handle over flow control spindle.
- 3) Tighten packing nut for positive frictional resistance as handle is rotated from shut-off position across adjustment range.

### 6. Installation - Setting Limit Stop Screw (Model Numbers Ending in TRMTC)

The temperature limit stop screw limits valve handle from being turned to maximum position resulting in excessive hot water discharge temperatures.

**⚠ WARNING:** Failure to adjust limit stop screw properly may result in serious scalding.

- 1) Turn hot and cold supplies on. Valve will not operate unless both hot and cold water supply pressures are on.
- 2) Place handle on flow control spindle and open valve to maximum desired temperature.
- 3) Turn limit stop screw clockwise until it seats.

## 7. Parts Breakdown

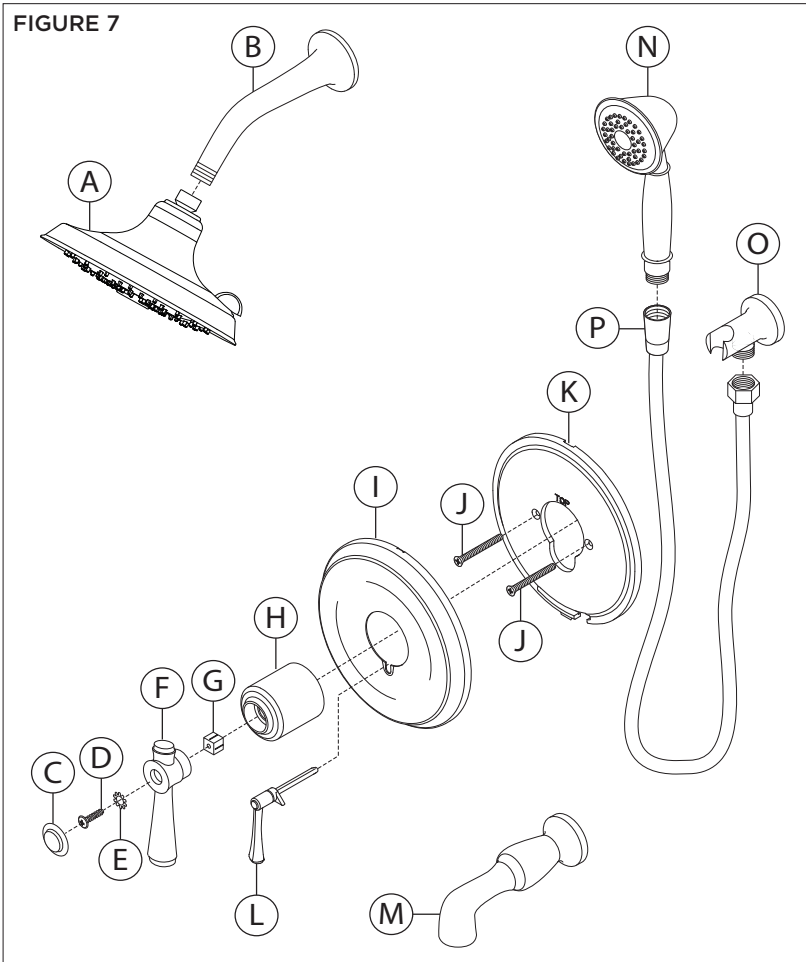

\*Order in-line vacuum breaker (EF-109) for hand shower systems without dual checks.

Replacement Parts		
Item	Description	Part Number
A	Showerhead	511SH
B	Shower Arm	522SA
C	Plug Button	T-694
D	Screw	
E	Star Washer	
F	Handle	RTS-085
G	Insert	
H	Dome Cover	RTS-022
I	Shower Escutcheon	
J	Screws	
K	Mounting Plate	T-695-ASM
L	Diverter/Volume Control Handle	
M	Tub Spout	542TS
N	Hand Shower	462W
O	Wall Cradle	T-635
P	60" Hose	RTS-045

### Notes:

- 1) Append appropriate suffix for premium finish.
- 2) Append appropriate flow rate to showerhead or hand shower for low flow.
- 3) Apply a bead of silicone around the perimeter of all shower trim installed flush to the finished wall. Leave opening on bottom of escutcheons for weep hole.
- 4) Apply plumber tape to all threaded connections.

## 8. Installation - Shower Valve Trim

- 1) Secure large mounting plate to Temptrol pressure balancing valve using mounting screws (FIGURE 8.1).
- 2) Place diverter/volume control handle into slot in shower escutcheon (FIGURE 8.2).
- 3) Secure large shower escutcheon to mounting plate. Guide handle into control port on valve body. Tabs should snap in place (FIGURE 8.3).
- 4) Install dome cover by turning clockwise (FIGURE 8.4).
- 5) Place nylon insert into handle. Install handle to shower valve. Secure with star washer, set screw and plug button (FIGURE 8.4).

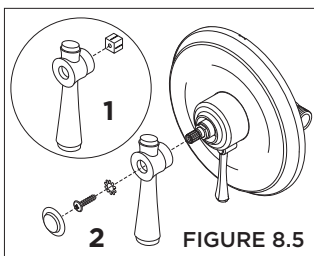
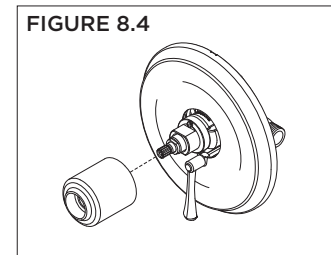
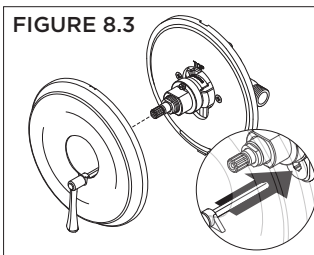
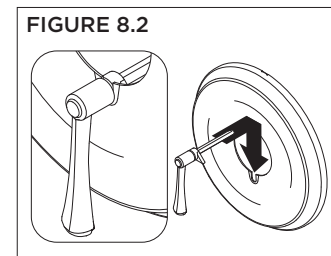
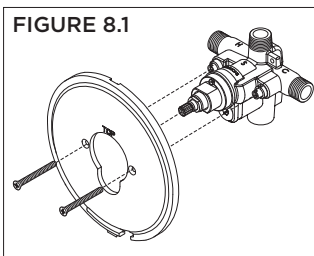

## 9. Installation - Showerhead & Tub Spout

- 1) Attach shower arm to shower pipe. Turn clockwise to tighten (FIGURE 9.1).
- 2) Install showerhead to shower arm. Turn clockwise to tighten (FIGURE 9.2).
- 3) Install tub spout to stub out pipe. Turn clockwise to tighten (FIGURE 9.3).

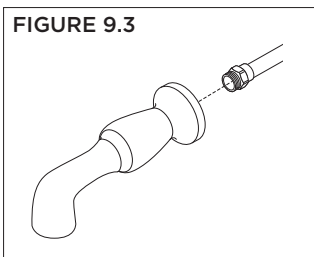
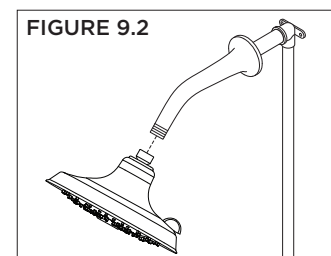
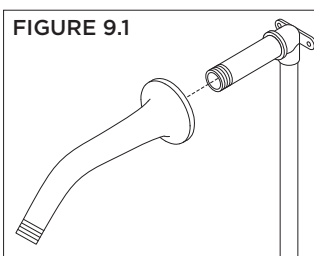

## 10. Installation - Slide Bar Assembly

- 1) Install wall cradle to stub out pipe. Turn clockwise to tighten (FIGURE 10.1).
- 2) Verify washer has been inserted into vacuum breaker so as to form a tight face seal. Attach vacuum breaker to wall cradle. Turn clockwise to tighten (FIGURE 10.2).
- 3) Attach small end of hand shower hose to vacuum breaker. Turn clockwise to tighten (FIGURE 10.3).
- 4) Attach large end of hand shower hose to hand shower wand. Turn clockwise to tighten (FIGURE 10.4).

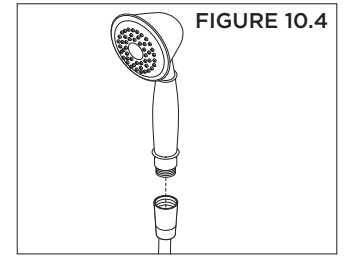
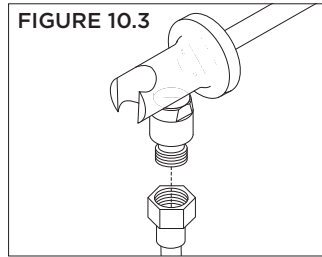
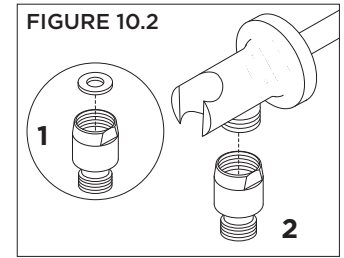
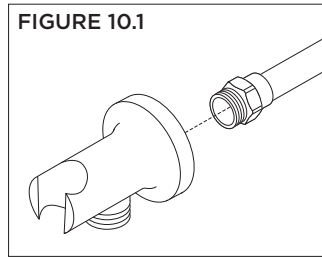

---

## 11. Operation (Temperature Control)

---

- 1) Turn shower handle counter-clockwise approximately 1/4 turn to put valve in cold position (FIGURE 11.1).
- 2) Turn shower handle counter-clockwise approximately 1/2 turn to put valve in warm position (FIGURE 11.2).
- 3) Turn shower handle counter-clockwise approximately 3/4 turn to put valve in hot position (FIGURE 11.3).

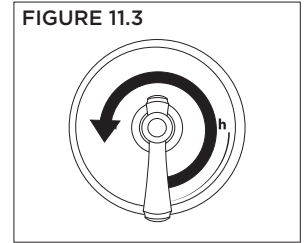
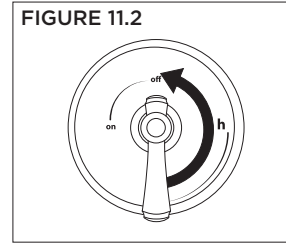
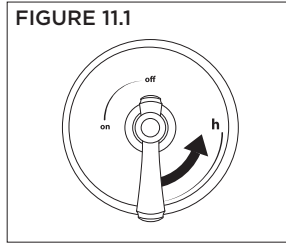

---

## 12. Operation (VersaFlex™ Diverter Control)

---

Turn diverter control handle clockwise to divert to **tub spout** or other Symmons **accessory**.

Turn diverter control handle counterclockwise to divert to **shower** or other Symmons **accessory**.

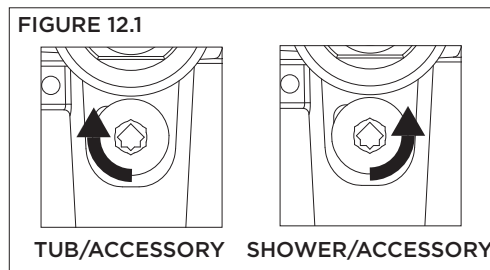

---

## 13. Operation (Volume Control)

---

Turn volume control handle clockwise to **increase** volume.

Turn volume control handle counterclockwise to **decrease** volume.

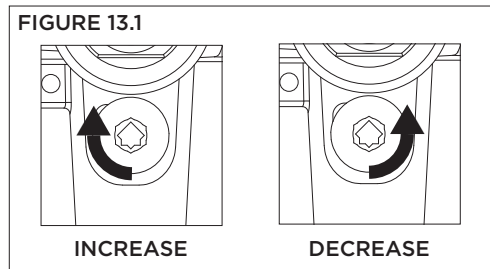

---

## 14. Troubleshooting Chart

---

Problem	Cause	Solution
Finish is spotting.	Elements in water supply may cause water staining on finish.	Clean finished trim area with a soft cloth using mild soap and water or a non-abrasive cleaner and then quickly rinse with water.

 **WARNING:** This product can expose you to chemicals including lead, which is known to the state of California to cause cancer, birth defects, or other reproductive harm. For more information, go to [www.P65Warnings.ca.gov](http://www.P65Warnings.ca.gov).