

Origins Trim Series

Origins Trim Series with TA-10 Flow Control Spindle & T-12A Cap Assembly Installation & Operation Instructions

Model Numbers

TRIM ONLY

9600-P-TRM Shower Valve Trim	9600-PLR-TRM Shower Valve Trim	9601-P-TRM Shower Trim	9601-PLR-TRM Shower Trim	9602-P-TRM Tub/Shower Trim	9602-PLR-TRM Tub/Shower Trim	9603-P-TRM Hand Shower Trim	9603-PLR-TRM Hand Shower Trim	9604-P-TRM Tub/Hand Shower Trim	9604-PLR-TRM Tub/Hand Shower Trim	9605-P-TRM Shower/Hand Shower Trim	9605-PLR-TRM Shower/Hand Shower Trim	9606-P-TRM Tub/Shower/Hand Shower Trim	9606-PLR-TRM Tub/Shower/Hand Shower Trim
--	--	----------------------------------	------------------------------------	--------------------------------------	--	---------------------------------------	---	---	---	--	--	--	--

TRIM, TA-10, T-12A

9600PTRMTC Shower Valve Trim	9600PLRTRMTC Shower Valve Trim	9601PTRMTC Shower Trim	9601PLRTRMTC Shower Trim	9602PTRMTC Tub/Shower Trim	9602PLRTRMTC Tub/Shower Trim	9603PTRMTC Hand Shower Trim	9603PLRTRMTC Hand Shower Trim	9604PTRMTC Tub/Hand Shower Trim	9604PLRTRMTC Tub/Hand Shower Trim	9605PTRMTC Shower/Hand Shower Trim	9605PLRTRMTC Shower/Hand Shower Trim	9606PTRMTC Tub/Shower/Hand Shower Trim	9606PLRTRMTC Tub/Shower/Hand Shower Trim
--	--	----------------------------------	------------------------------------	--------------------------------------	--	---------------------------------------	---	---	---	--	--	--	--

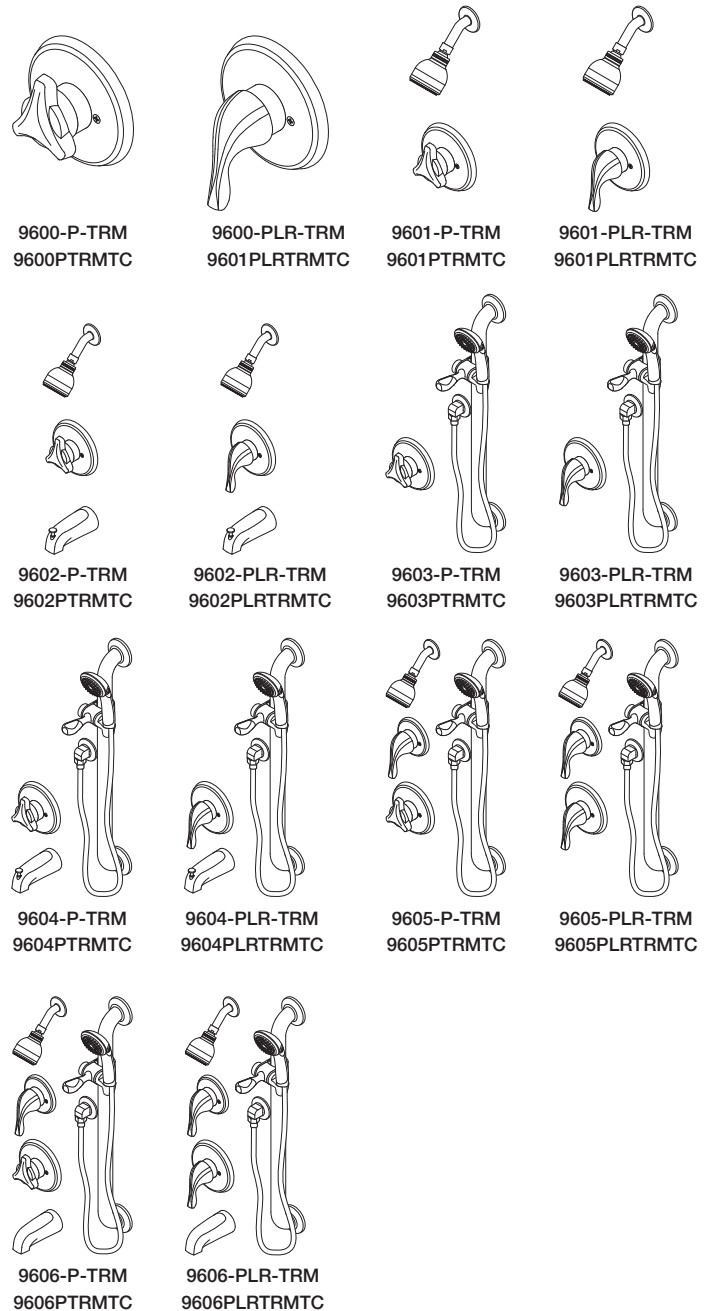
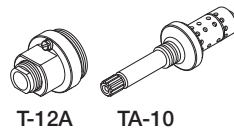

Compliance

- ASME A112.18.1/CSA B125.1



Warranty

Limited Lifetime - to the original end purchaser in consumer/residential installations.
5 Years - for industrial/commercial installations.
 Refer to www.symmons.com/warranty for complete warranty information.
 Go to www.symmons.com/register to register your Symmons product.

1. Recommended Tools

FIGURE 1

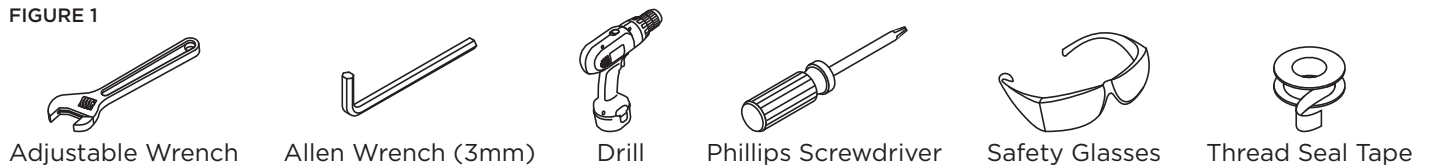

2. Dimensions

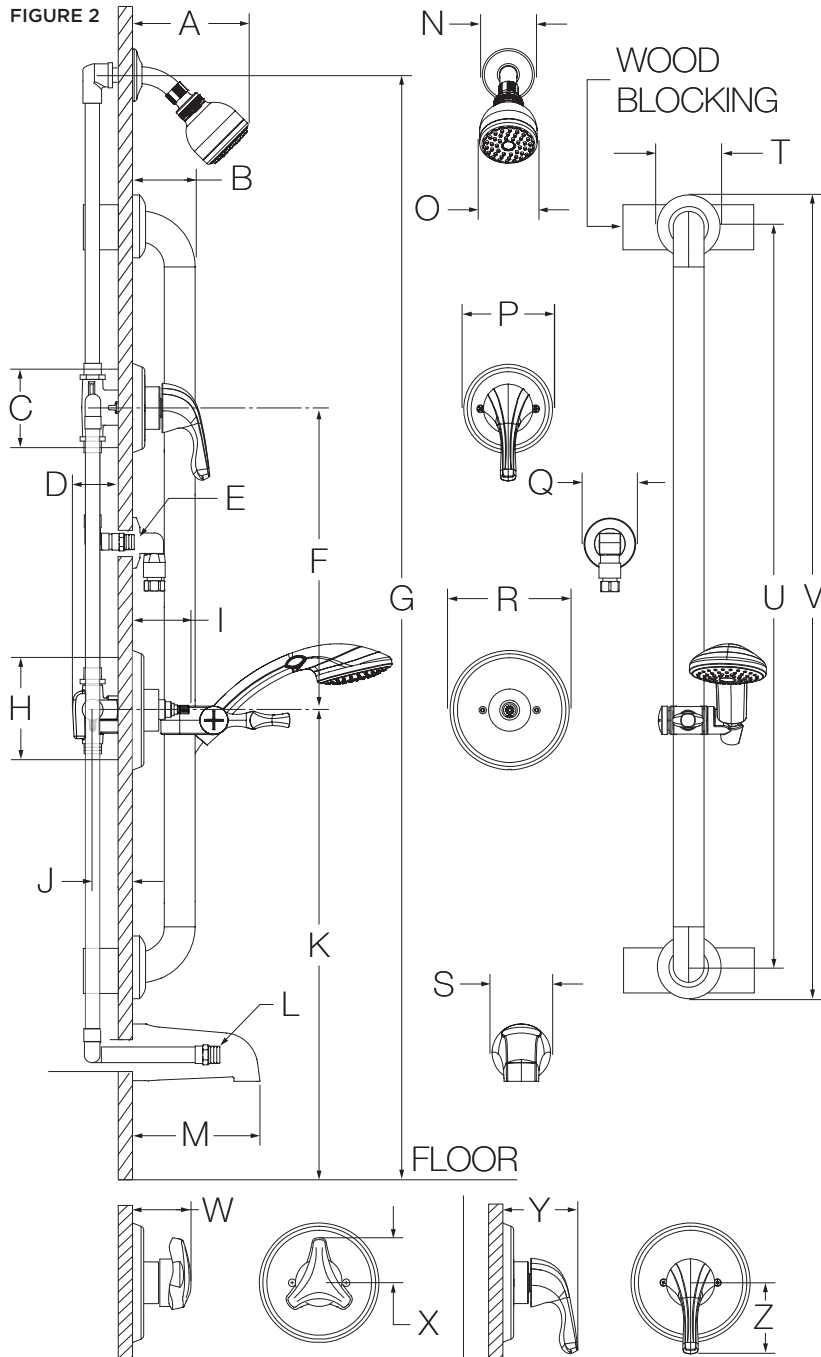

Measurements	
A	6-3/8", 162 mm
B	3", 76 mm
C	Diverter Valve Hole Size Min. Ø 3", 76 mm Max. Ø 3-1/4", 83 mm
D	3 1/2", 89 mm
E	Male 1/2" NPT fitting must protrude 3/8" from finished wall
F	Ref. 10", 254 mm
G	Ref. 77", 1956 mm
H	Shower Valve Hole Size Min. Ø 3", 76 mm Max. Ø 4", 102 mm
I	2-7/8", 73 mm
J	Rough-in 2-3/8" ± 1/2", 60 mm ± 13 mm
K	9600, 9601, 9603, 9605: Ref. 42", 1067 mm 9602, 9604, 9606: Ref. 32", 813 mm
L	Male 1/2" NPT fitting must protrude 4" from finished wall
M	5-1/2", 140 mm
N	Ø 2-1/2", 64 mm
O	Ø 2-3/4", 70 mm
P	Ø 4-1/4", 108 mm
Q	Ø 2-1/2", 64 mm
R	Ø 5-3/4", 146 mm
S	Ø 2-1/2", 64 mm
T	Ø 3-1/8", 79 mm
U	36", 914 mm
V	39", 991 mm
W	2-7/8", 73 mm
X	2-1/8", 54 mm
Y	3-5/8", 92 mm
Z	3-3/8", 86 mm

Notes:

- 1) Valve body and piping not included and shown as reference only.
- 2) Plaster shield (p/n T-176) for dry wall, plaster or other type walls 1/2" or greater.
- 3) All dimensions measured from nominal rough-in (see J as reference).
- 4) Dimensions subject to change without notice.

3. Parts Breakdown (Model Numbers Ending in TRMTC)

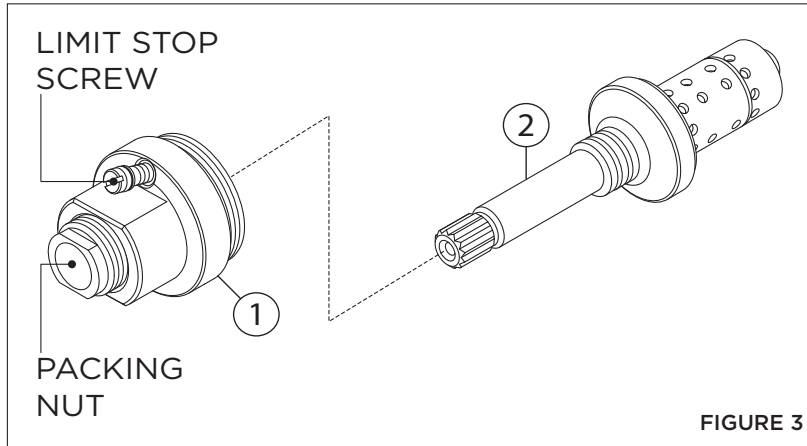

Replacement Parts		
Item	Description	Part Number
1	Cap Assy.	T-12A
2	Flow Control Spindle	TA-10

IMPORTANT: Model numbers ending in **TRMTC** coordinate with Temptrol pressure balancing valves ordered with Test Cap. The Test Cap is used to allow pressurization of system. **Do not** remove test cap from valve during wall construction, installation of valve or pressurization of system.

4. Installation - Remove Test Cap (Model Numbers Ending in TRMTC)

Flow control spindle (TA-10) and cap assembly (T-12A) will come factory assembled for all model numbers ending in **TRMTC**. When ready to remove Test Cap and install trim, follow the instructions below:

- 1) Check for leaks around the valve assembly and all pipe fittings.
- 2) Remove test cap from valve (FIGURE 4.1).
- 3) If system is dirty, flush valve.
- 4) Thread flow control spindle and cap assembly into valve body. Turn clockwise to secure to valve (FIGURE 4.2).

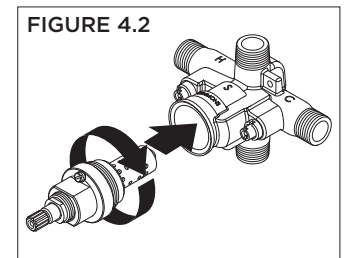
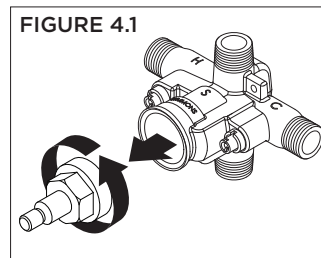

5. Installation - Adjust Packing Nut (Model Numbers Ending in TRMTC)

- 1) Turn hot and cold supplies on. Valve will not operate unless both hot and cold water supply pressures are on.
- 2) Place handle over flow control spindle.
- 3) Tighten packing nut for positive frictional resistance as handle is rotated from shut-off position across adjustment range.

6. Installation - Setting Limit Stop Screw (Model Numbers Ending in TRMTC)

The temperature limit stop screw limits valve handle from being turned to maximum position resulting in excessive hot water discharge temperatures.

⚠ WARNING: Failure to adjust limit stop screw properly may result in serious scalding.

- 1) Turn hot and cold supplies on. Valve will not operate unless both hot and cold water supply pressures are on.
- 2) Place handle on flow control spindle and open valve to maximum desired temperature.
- 3) Turn limit stop screw clockwise until it seats.

7. Parts Breakdown

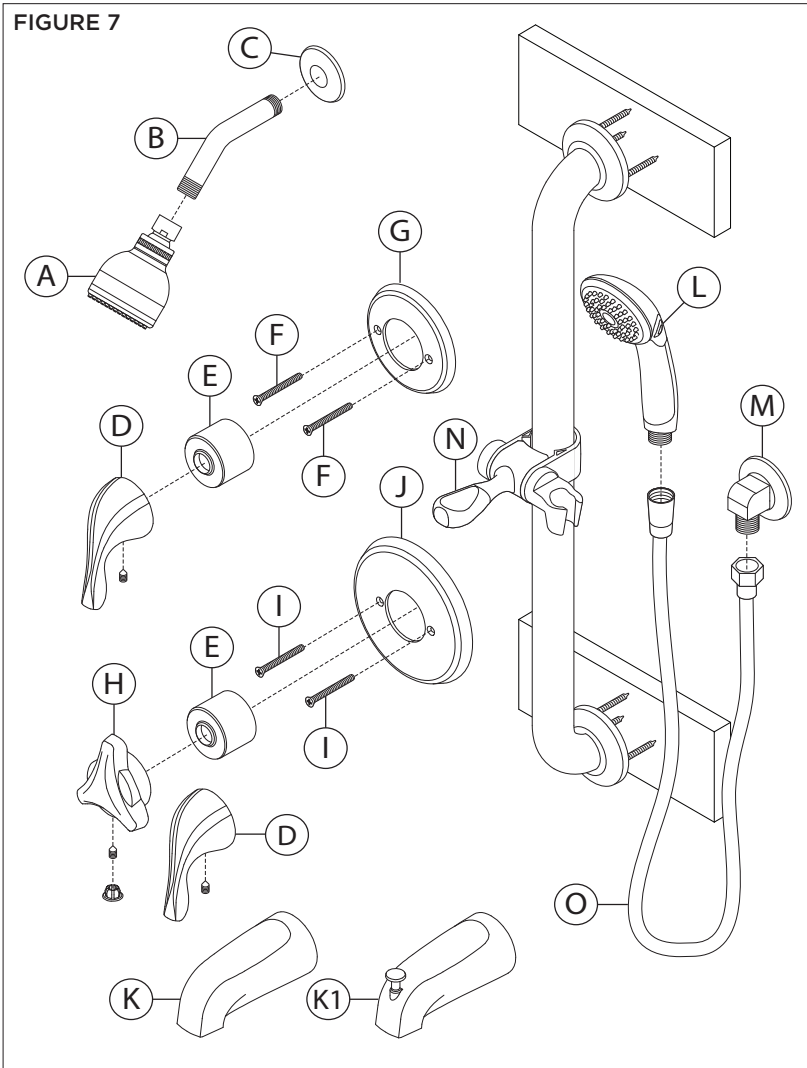

Replacement Parts		
Item	Description	Part Number
A	Showerhead	4-141
B	Shower Arm	
C	Shower Arm Flange	300S
D	'PLR' Handle	RTS-063
E	Dome Cover	T-19
F	Diverter Escutcheon	
G	Screws	96-66-DIV-ESC
H	'P' Handle	RTS-061
I	Shower Escutcheon Screws	Standard: 9600-P-ESC
J		Brass: 9600-P-B-ESC
K	Tub Spout	060
K1	Diverter Tub Spout	054
L	Hand Shower	ADACHS
M	Wall Elbow	40A
N	Slide Mechanism	FP-SM6
O	60" Hose	RTS-045

Notes:

- 1) Append appropriate suffix for premium finish.
- 2) Append appropriate flow rate to showerhead or hand shower for low flow.
- 3) Apply a bead of silicone around the perimeter of all shower trim installed flush to the finished wall. Leave opening on bottom of escutcheons for weep hole.
- 4) Apply plumber tape to all threaded connections.



*Order in-line vacuum breaker (EF-109) for hand shower systems without dual checks.

8. Installation - Shower Valve Trim

- 1) Secure large shower escutcheon to Temptrol pressure balancing valve using mounting screws (FIGURE 8.1).
- 2) Install dome cover by turning clockwise (FIGURE 8.2).
- 3) Install 'P' handle to shower valve. Secure with set screw. Install plug button (FIGURE 8.3).
- 4) Install 'PLR' handle to shower valve. Secure with set screw (FIGURE 8.4).

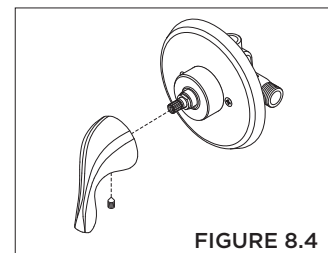
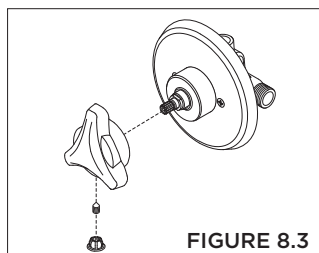
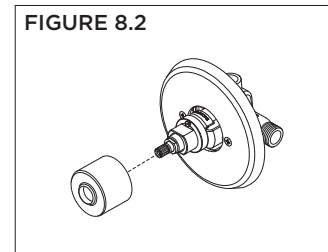
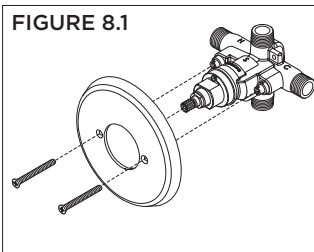

9. Installation - Diverter Valve Trim

- 1) Secure small diverter escutcheon to Symmons diverter valve using mounting screws (FIGURE 9.1).
- 2) Install dome cover by turning clockwise (FIGURE 9.2).
- 3) Install handle to diverter valve. Secure with set screw (FIGURE 9.3).

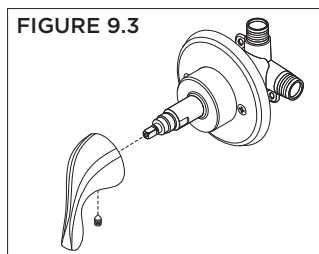
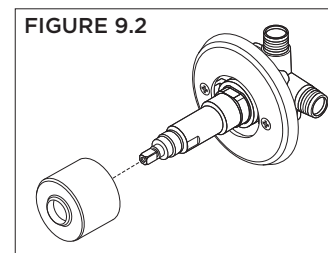
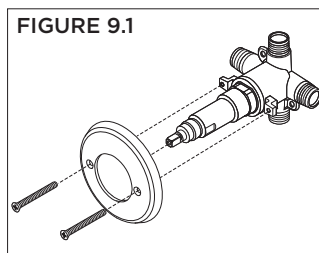

10. Installation - Showerhead & Tub Spout

- 1) Attach arm and flange to shower pipe. Turn clockwise to tighten (FIGURE 10.1).
- 2) Install showerhead to shower arm. Turn clockwise to tighten (FIGURE 10.2).
- 3) Install tub spout to stub out pipe. Turn clockwise to tighten (FIGURE 10.3).

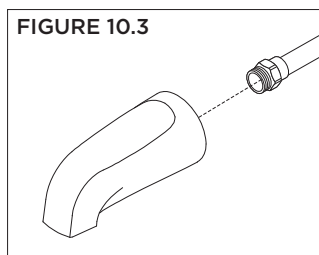
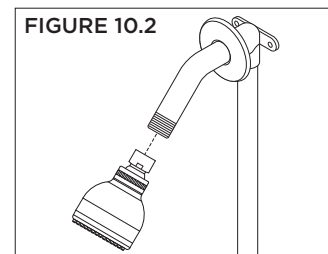
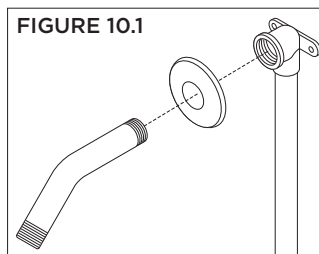

11. Installation - Slide Bar Assembly

- 1) Remove slide bar ends from slide bar flanges. Using flanges as a guide, drill 1/8" pilot holes into studs or wood blocking. With slide bar in position, secure to wall using screws. Attach slide bar ends to bar flanges (FIGURE 11.1).
- 2) Remove screw cap from slide mechanism (FIGURE 11.2).
- 3) Remove wand holder from slide mechanism (FIGURE 11.3).
- 4) Remove lever handle from slide mechanism (FIGURE 11.4).
- 5) Install slide mechanism components to slide bar following STEPS 11.2 - 11.4 in reverse. Flat edge on (N1) and (N2) must be aligned. Arrows on (N1) and (N3) identify bottom side (FIGURE 11.5).
Note: Adjust screw cap for ease of movement of slide assembly.
- 6) Press tabs on wall elbow flange. Install wall elbow to pipe fitting. Turn clockwise to secure (FIGURE 11.6).
- 7) Attach small end of hand shower hose to wall elbow. Turn clockwise to tighten (FIGURE 11.7).
- 8) Attach large end of hand shower hose to hand shower wand. Turn clockwise to tighten (FIGURE 11.8).

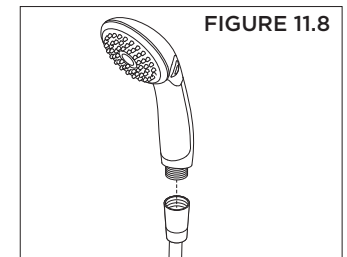
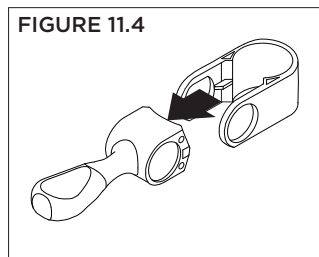
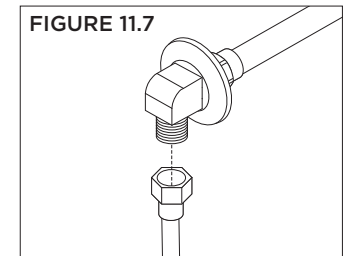
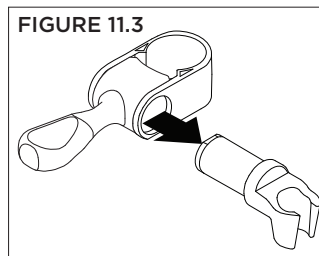
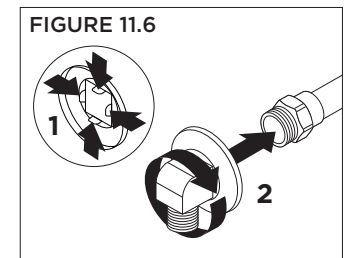
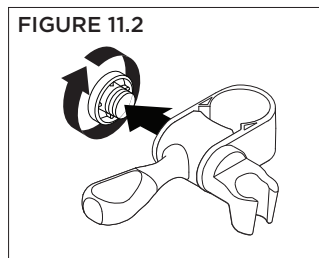
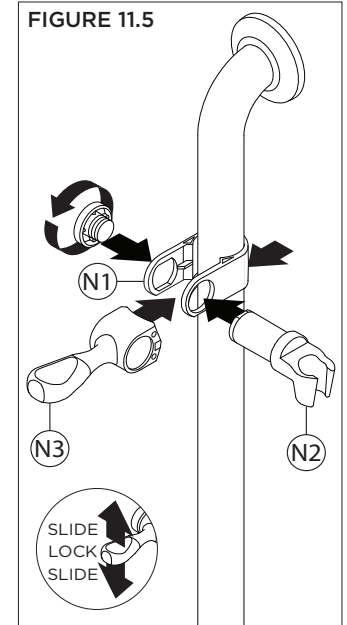
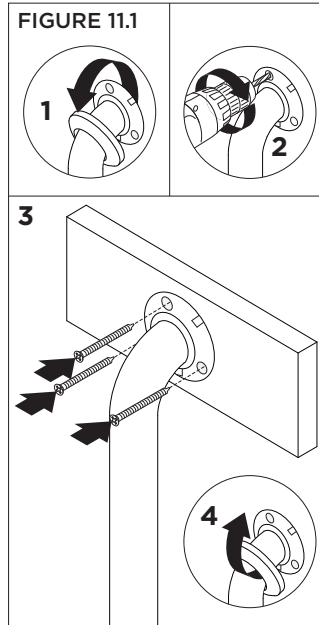

12. Operation (Temperature Control)

- 1) Turn shower handle counter-clockwise approximately 1/4 turn to put valve in cold position (FIGURE 12.1).
- 2) Turn shower handle counter-clockwise approximately 1/2 turn to put valve in warm position (FIGURE 12.2).
- 3) Turn shower handle counter-clockwise approximately 3/4 turn to put valve in hot position (FIGURE 12.3).

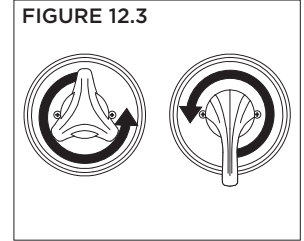
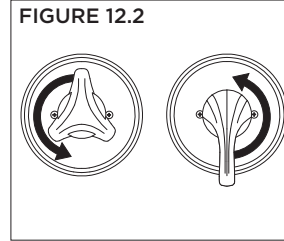
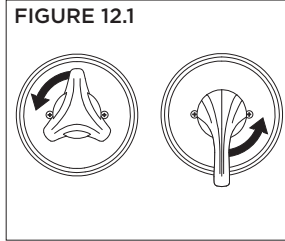

13. Operation (Dual Outlet Diverter Control)

Note: Additional handle positions for same output are illustrated.

- 1) Cartridge is factory set to divert to function 1 (FIGURE 13.1).
- 2) Turn handle to position 2 to divert to function 2 (FIGURE 13.2).
- 3) Turn handle to position 3 to share functions 1 and 2 (FIGURE 13.3).

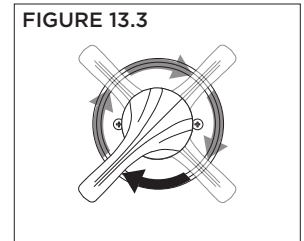
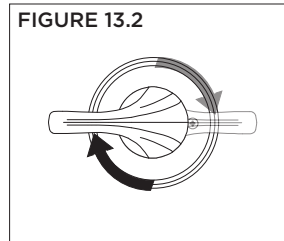
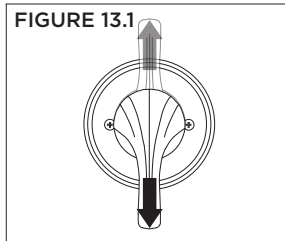

14. Operation (Triple Outlet Diverter Control)

- 1) Cartridge is factory set to divert to function 1 (FIGURE 14.1).
- 2) Turn handle to position 2 to divert to function 2 (FIGURE 14.2).
- 3) Turn handle to position 3 to divert to function 3 (FIGURE 14.3).
- 4) Turn handle to position 4 to share functions 2 and 3 (FIGURE 14.4).
- 5) Turn handle to position 5 to share functions 1 and 3 (FIGURE 14.5).
- 6) Turn handle to position 6 to share functions 1 and 2 (FIGURE 14.6).

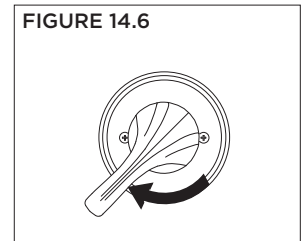
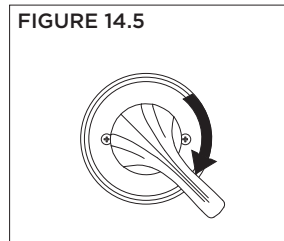
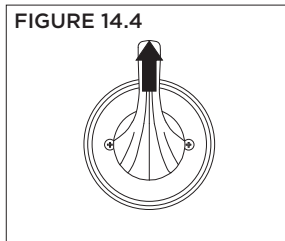
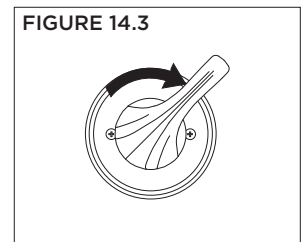
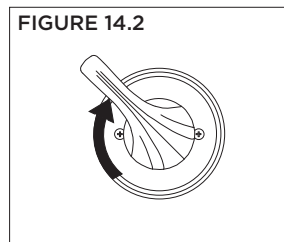
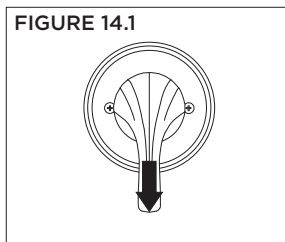

15. Troubleshooting Chart

Problem	Cause	Solution
Finish is spotting.	Elements in water supply may cause water staining on finish.	Clean finished trim area with a soft cloth using mild soap and water or a non-abrasive cleaner and then quickly rinse with water.

 **WARNING:** This product can expose you to chemicals including lead, which is known to the state of California to cause cancer, birth defects, or other reproductive harm. For more information, go to www.P65Warnings.ca.gov.