

Unity Trim Series

Unity Trim Series with TA-10 Flow Control Spindle & T-12A Cap Assembly
Installation & Operation Instructions

Model Numbers

TRIM ONLY

- 6600-TRM**
Shower Valve Trim
- 6601-TRM**
Shower Trim
- 6602-TRM**
Tub/Shower Trim
- 6603-TRM**
Hand Shower Trim
- 6604-TRM**
Tub/Hand Shower Trim
- 6605-TRM**
Shower/Hand Shower Trim
- 6606-TRM**
Tub/Shower/Hand Shower Trim

TRIM, TA-10, T-12A

- 6600TRMTC**
Shower Valve Trim
- 6601TRMTC**
Shower Trim
- 6602TRMTC**
Tub/Shower Trim
- 6603TRMTC**
Hand Shower Trim
- 6604TRMTC**
Tub/Hand Shower Trim
- 6605TRMTC**
Shower/Hand Shower Trim
- 6606TRMTC**
Tub/Shower/Hand Shower Trim

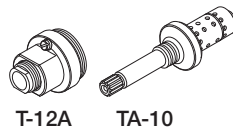

6600-TRM
6600TRMTC



6601-TRM
6601TRMTC



6602-TRM
6602TRMTC



6603-TRM
6603TRMTC



6604-TRM
6604TRMTC

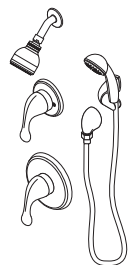

6605-TRM
6605TRMTC



6606-TRM
6606TRMTC

Compliance

- ASME A112.18.1/CSA B125.1



Warranty

Limited Lifetime - to the original end purchaser in consumer/residential installations.
5 Years - for industrial/commercial installations.
 Refer to www.symmons.com/warranty for complete warranty information.
 Go to www.symmons.com/register to register your Symmons product.

1. Recommended Tools

FIGURE 1

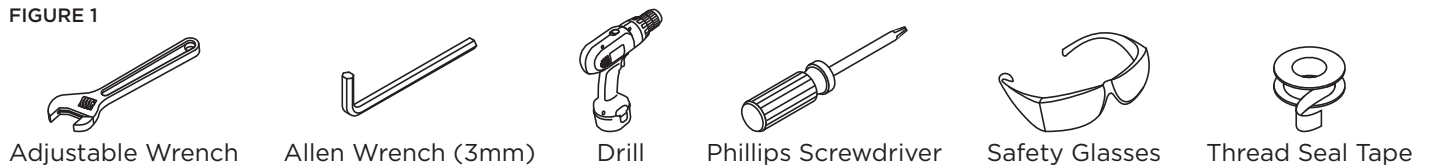

2. Dimensions

FIGURE 2

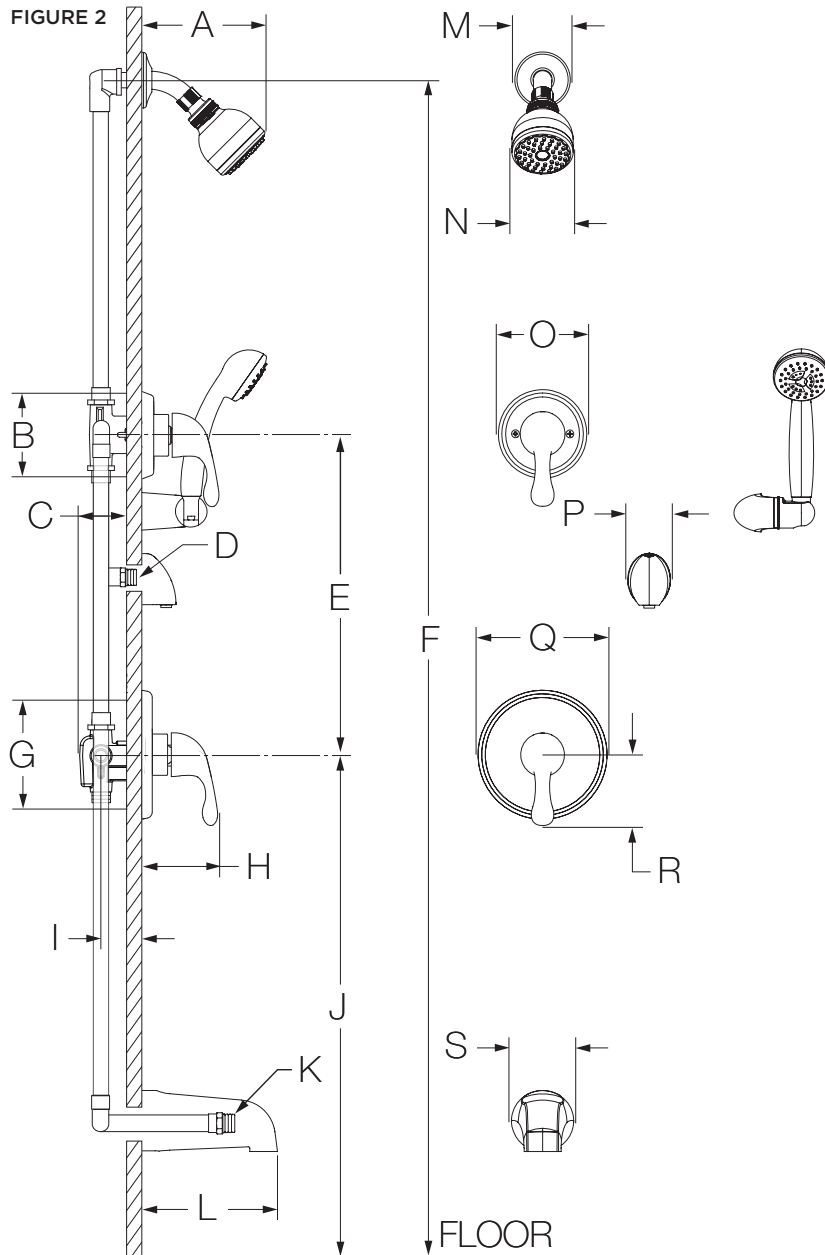

Measurements	
A	6-3/8", 162 mm
B	Diverter Valve Hole Size Min. Ø 3", 76 mm Max. Ø 3-1/4", 83 mm
C	3-1/2", 89 mm
D	Male 1/2" NPT fitting must be recessed 1/4" from finished wall
E	Ref. 10", 254 mm
F	Ref. 77", 1956 mm
G	Shower Valve Hole Size Min. Ø 3", 76 mm Max. Ø 4", 102 mm
H	3-3/4", 95 mm
I	Rough-in 2-3/8" ± 1/2", 60 mm ± 13 mm
J	Ref. 32", 813 mm
K	Male 1/2" NPT fitting must protrude 4" from finished wall
L	5-1/2", 140 mm
M	Ø 2-1/2", 64 mm
N	Ø 2-3/4", 70 mm
O	Ø 4-1/4", 108 mm
P	2-1/8", 54 mm
Q	Ø 6-3/8", 162 mm
R	3-1/2", 89 mm
S	Ø 2-1/2", 64 mm

Notes:

- 1) Valve body and piping not included and shown as reference only.
- 2) Plaster shield (p/n T-176) for dry wall, plaster or other type walls 1/2" or greater.
- 3) All dimensions measured from nominal rough-in (see I as reference).
- 4) Dimensions subject to change without notice.

3. Parts Breakdown (Model Numbers Ending in TRMTC)

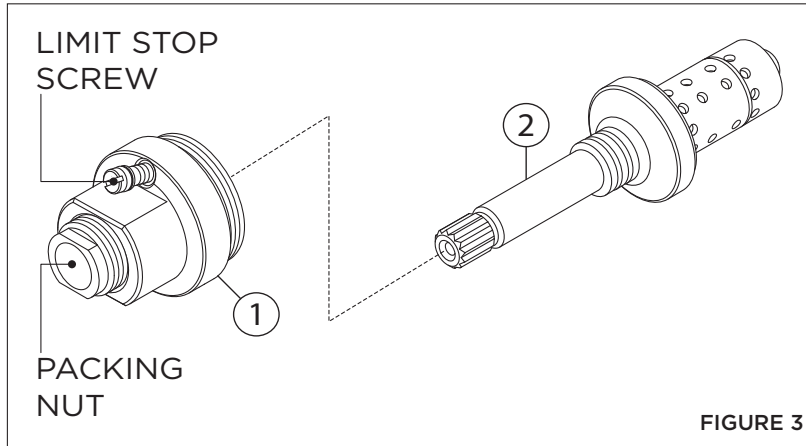

FIGURE 3

Replacement Parts		
Item	Description	Part Number
1	Cap Assy.	T-12A
2	Flow Control Spindle	TA-10

IMPORTANT: Model numbers ending in **TRMTC** coordinate with Temptrol pressure balancing valves ordered with Test Cap. The Test Cap is used to allow pressurization of system. **Do not** remove test cap from valve during wall construction, installation of valve or pressurization of system.

⚠ WARNINGS:

1. Do not expose valve with test cap to heat for longer than 2 minutes when soldering copper tubing. Doing so may damage the internal components of the valve and will void the product warranty.
2. Ensure test cap is **tightened securely** after soldering valve body.

4. Installation - Remove Test Cap (Model Numbers Ending in TRMTC)

Flow control spindle (TA-10) and cap assembly (T-12A) will come factory assembled for all model numbers ending in **TRMTC**. When ready to remove Test Cap and install trim, follow the instructions below:

- 1) Check for leaks around the valve assembly and all pipe fittings.
- 2) Remove test cap from valve (FIGURE 4.1).
- 3) If system is dirty, flush valve.
- 4) Thread flow control spindle and cap assembly into valve body. Turn clockwise to secure to valve (FIGURE 4.2).

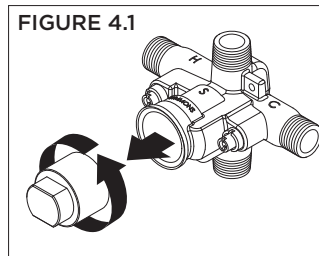

FIGURE 4.1

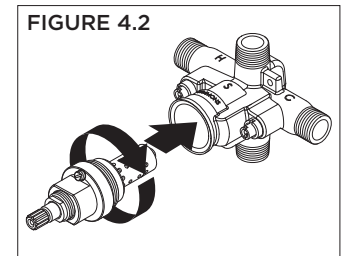

FIGURE 4.2

5. Installation - Adjust Packing Nut (Model Numbers Ending in TRMTC)

- 1) Turn hot and cold supplies on. Valve will not operate unless both hot and cold water supply pressures are on.
- 2) Place handle over flow control spindle.
- 3) Tighten packing nut for positive frictional resistance as handle is rotated from shut-off position across adjustment range.

6. Installation - Setting Limit Stop Screw (Model Numbers Ending in TRMTC)

The temperature limit stop screw limits valve handle from being turned to maximum position resulting in excessive hot water discharge temperatures.

⚠ WARNING: Failure to adjust limit stop screw properly may result in serious scalding.

- 1) Turn hot and cold supplies on. Valve will not operate unless both hot and cold water supply pressures are on.
- 2) Place handle on flow control spindle and open valve to maximum desired temperature.
- 3) Turn limit stop screw clockwise until it seats.

7. Parts Breakdown

FIGURE 7

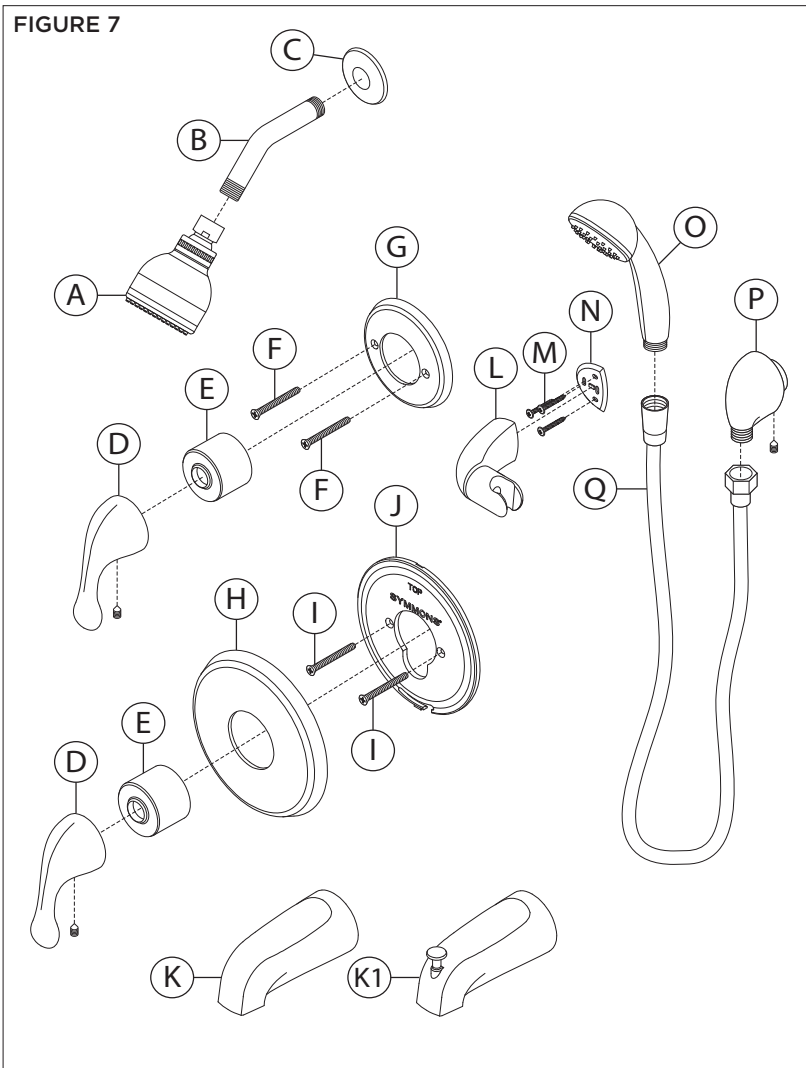

Replacement Parts		
Item	Description	Part Number
A	Showerhead	4-141
B	Shower Arm	300S
C	Showerhead Flange	300S
D	Handle Assy.	RTS-064
E	Dome Cover	T-19
F	Diverter Escutcheon	96-66-DIV-ESC
G	Escutcheon Screws	
H	Shower Escutcheon	6600-ESC
I	Escutcheon Screws	
J	Mounting Plate	
K	Tub Spout	060
K1	Diverter Tub Spout	054
L	Wall Cradle	
M	Wall Cradle Screws	EF-106
N	Mounting Plate	
O	Hand Shower	EF-100
P	Wall Elbow	EF-105
Q	60" Hose	RTS-045

Notes:

- 1) Append appropriate suffix for premium finish.
- 2) Append appropriate flow rate to showerhead or hand shower for low flow.
- 3) Apply a bead of silicone around the perimeter of all shower trim installed flush to the finished wall. Leave opening on bottom of escutcheons for weep hole.
- 4) Apply plumber tape to all threaded connections.



*Order in-line vacuum breaker (EF-109) for hand shower systems without dual checks.

8. Installation - Shower Valve Trim

- 1) Secure large mounting plate to Temptrol pressure balancing valve using mounting screws (FIGURE 8.1).
- 2) Secure large shower escutcheon to mounting plate. Tabs should snap in place (FIGURE 8.2).
- 3) Install dome cover by turning clockwise (FIGURE 8.3).
- 4) Install handle to shower valve. Secure with set screw (FIGURE 8.4).

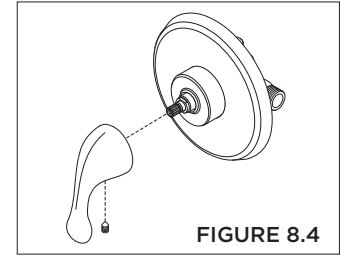
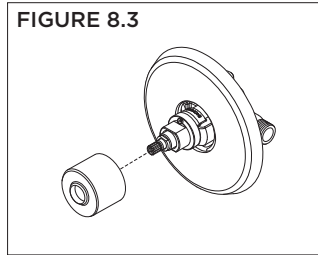
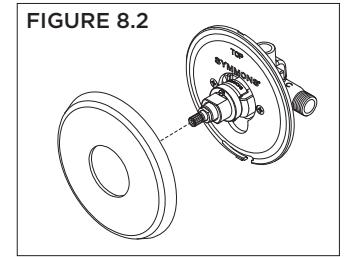
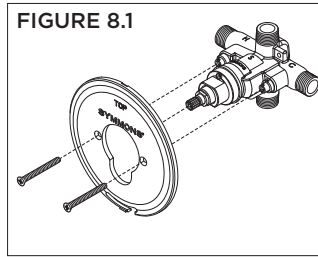

9. Installation - Diverter Valve Trim

- 1) Secure small diverter escutcheon to Symmons diverter valve using mounting screws (FIGURE 9.1).
- 2) Install dome cover by turning clockwise (FIGURE 9.2).
- 3) Install handle to diverter valve. Secure with set screw (FIGURE 9.3).

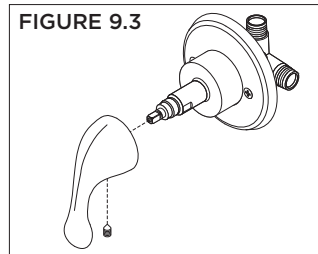
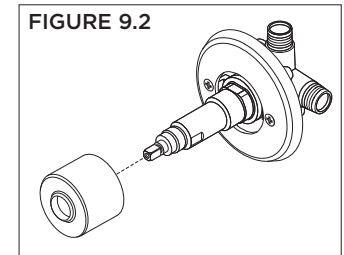
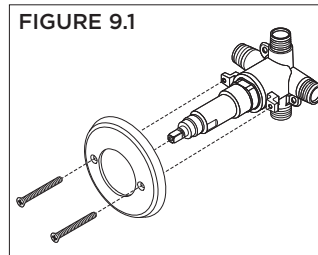

10. Installation - Showerhead & Tub Spout

- 1) Attach arm and flange to shower pipe. Turn clockwise to tighten (FIGURE 10.1).
- 2) Install showerhead to shower arm. Turn clockwise to tighten (FIGURE 10.2).
- 3) Install tub spout to stub out pipe. Turn clockwise to tighten (FIGURE 10.3).

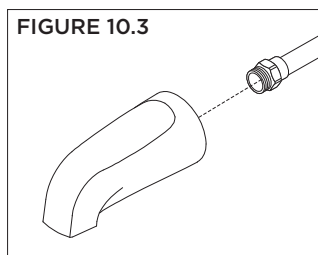
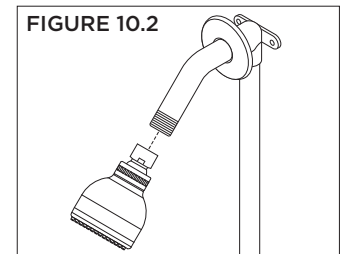
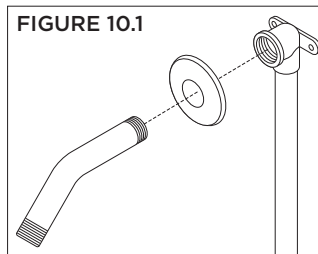

11. Installation - Slide Bar Assembly

1) Place mounting plate in position. Mark and drill $3/16''$ holes for tile anchors, $5/16''$ holes for drywall anchors. Install anchors (FIGURE 11.1).

Note: For dry wall $1/2''$ thick or less, insert anchor tool into drywall anchor to secure behind wall prior to installing wall cradle.

2) Remove cover of hand shower cradle. Install cradle and mounting plate. Secure with three screws. Replace cover on hand shower cradle (FIGURE 11.2).

3) Install wall elbow to stub out pipe. Tighten set screw to secure (FIGURE 11.3).

4) Attach small end of hand shower hose to wall elbow. Turn clockwise to tighten (FIGURE 11.4).

5) Attach large end of hand shower hose to hand shower wand. Turn clockwise to tighten (FIGURE 11.5).

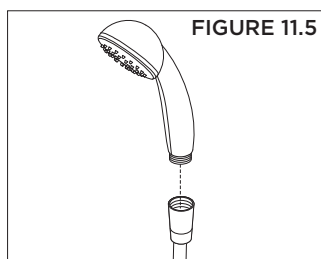
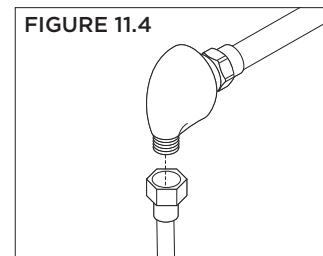
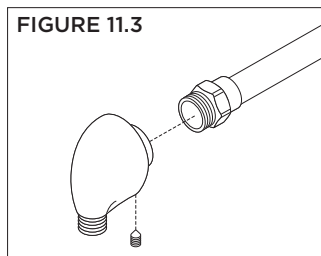
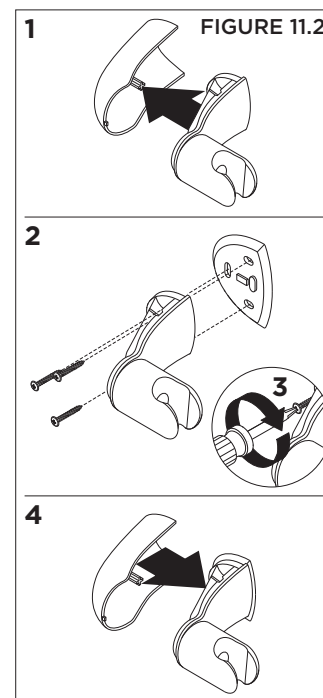
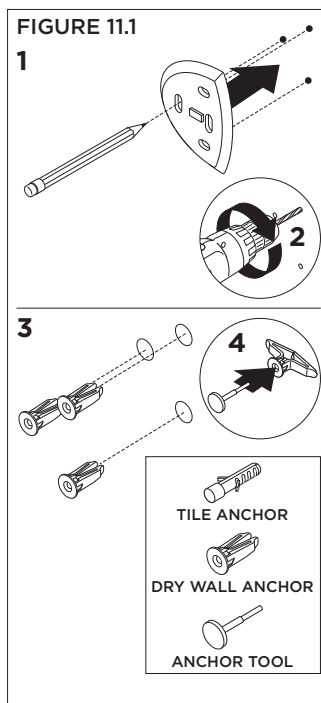

12. Operation (Temperature Control)

- 1) Turn shower handle counter-clockwise approximately 1/4 turn to put valve in cold position (FIGURE 12.1).
- 2) Turn shower handle counter-clockwise approximately 1/2 turn to put valve in warm position (FIGURE 12.2).
- 3) Turn shower handle counter-clockwise approximately 3/4 turn to put valve in hot position (FIGURE 12.3).

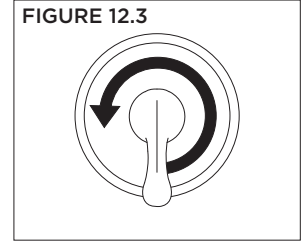
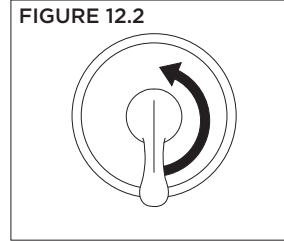
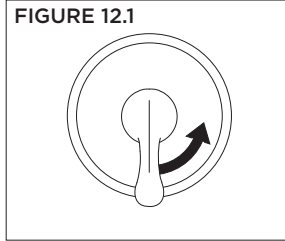

13. Operation (Dual Outlet Diverter Control)

Note: Additional handle positions for same output are illustrated.

- 1) Cartridge is factory set to divert to function 1 (FIGURE 13.1).
- 2) Turn handle to position 2 to divert to function 2 (FIGURE 13.2).
- 3) Turn handle to position 3 to share functions 1 and 2 (FIGURE 13.3).

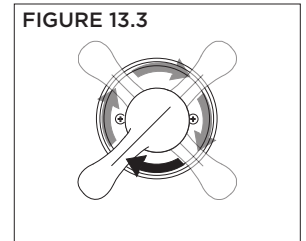
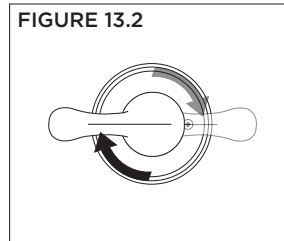
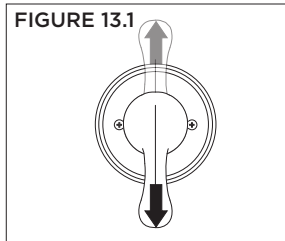

14. Operation (Triple Outlet Diverter Control)

- 1) Cartridge is factory set to divert to function 1 (FIGURE 14.1).
- 2) Turn handle to position 2 to divert to function 2 (FIGURE 14.2).
- 3) Turn handle to position 3 to divert to function 3 (FIGURE 14.3).
- 4) Turn handle to position 4 to share functions 2 and 3 (FIGURE 14.4).
- 5) Turn handle to position 5 to share functions 1 and 3 (FIGURE 14.5).
- 6) Turn handle to position 6 to share functions 1 and 2 (FIGURE 14.6).

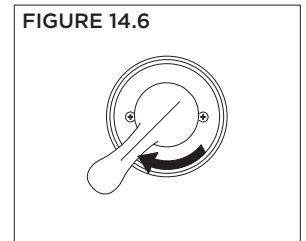
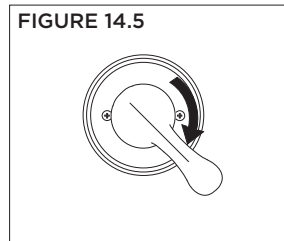
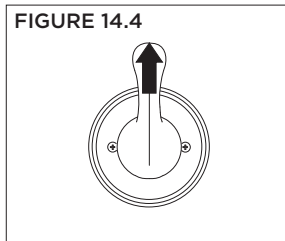
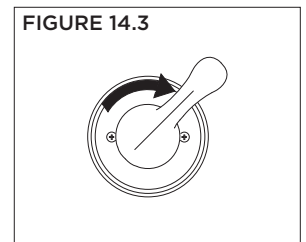
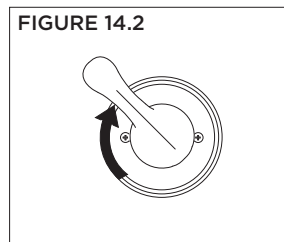
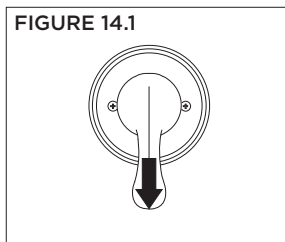

15. Troubleshooting Chart

Problem	Cause	Solution
Finish is spotting.	Elements in water supply may cause water staining on finish.	Clean finished trim area with a soft cloth using mild soap and water or a non-abrasive cleaner and then quickly rinse with water.

 **WARNING:** This product can expose you to chemicals including lead, which is known to the state of California to cause cancer, birth defects, or other reproductive harm. For more information, go to www.P65Warnings.ca.gov.