



SYMMONS[®] Carrington[®]

the smart choice[™]

Carrington Trim Series

Carrington Trim Series with TA-10 Flow Control Spindle & T-12A Cap Assembly

Installation & Operation Instructions

Model Numbers

TRIM ONLY

4400-TRM
Shower Valve Trim

4401-TRM
Shower Trim

4403-TRM
Hand Shower Trim

4405-TRM
Shower/Hand Shower Trim

4406-TRM
Tub/Shower/Hand Shower Trim

TRIM, TA-10, T-12A

4400TRMTC
Shower Valve Trim

4401TRMTC
Shower Trim

4403TRMTC
Hand Shower Trim

4405TRMTC
Shower/Hand Shower Trim

4406TRMTC
Tub/Shower/Hand Shower Trim

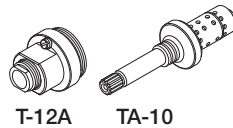

T-12A

TA-10



4400-TRM
4400TRMTC



4401-TRM
4401TRMTC

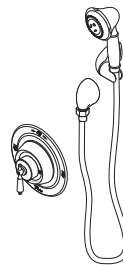

4403-TRM
4403TRMTC

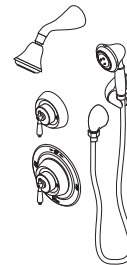

4405-TRM
4405TRMTC

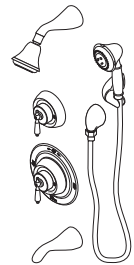

4406-TRM
4406TRMTC

Compliance

- ASME A112.18.1/CSA B125.1



Warranty

Limited Lifetime - to the original end purchaser in consumer/residential installations.

5 Years - for industrial/commercial installations.

Refer to www.symmons.com/warranty for complete warranty information.

Go to www.symmons.com/register to register your Symmons product.

1. Recommended Tools

FIGURE 1

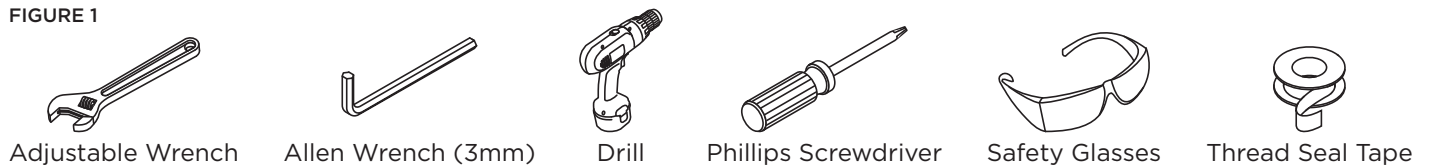

2. Dimensions

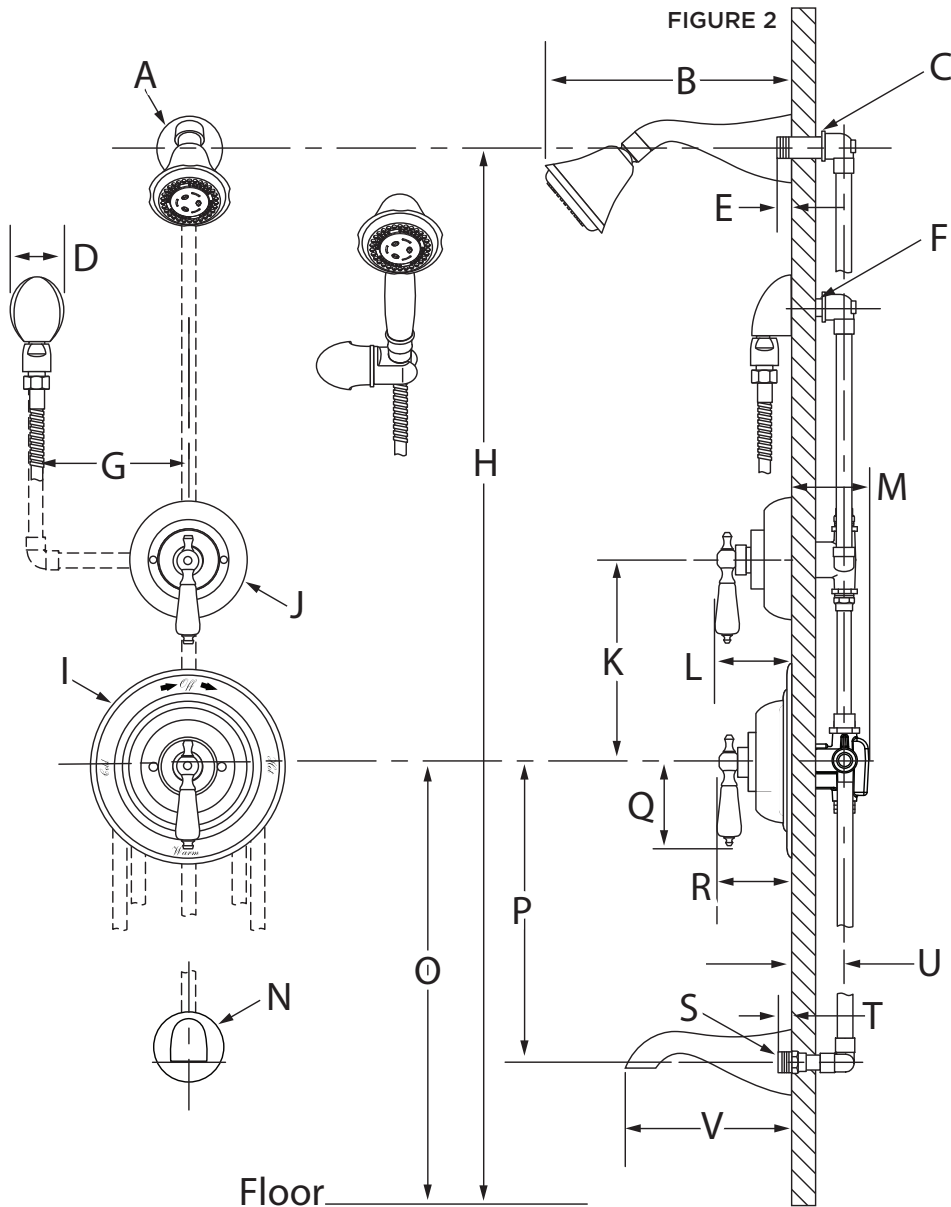

Measurements

A	Ø 2-5/8", 67 mm
B	9-1/4", 235 mm
C	1/2" NPT
D	2-1/8", 54 mm
E	1/2", 13 mm
F	Male 1/2" IPS thread must be recessed 1/4" from finished wall
G	6", 152 mm right or left
H	77", 1956 mm
I	Ø 7-1/2", 191 mm
J	Ø 4-5/8", 117 mm
K	8", 203 mm
L	2-7/8", 73 mm
M	4-3/8", 111 mm
N	Ø 2-5/8", 67 mm
O	4400, 4401, 4403, 4405: Ref. 42", 1067 mm 4406: Ref. 32", 813 mm
P	12", 305 mm
Q	3-1/8", 79 mm
R	2-3/4", 70 mm
S	1/2" NPT
T	1/2", 13 mm
U	(Rough in) 2" ± 1/2", 51 mm ± 13 mm
V	6-1/2", 165 mm

Notes:

- 1) Valve body and piping not included and shown as reference only.
- 2) Plaster shield (p/n T-176) for dry wall, plaster or other type walls 1/2" or greater.
- 3) All dimensions measured from nominal rough-in (see U as reference).
- 4) Dimensions subject to change without notice.

3. Parts Breakdown (Model Numbers Ending in TRMTC)

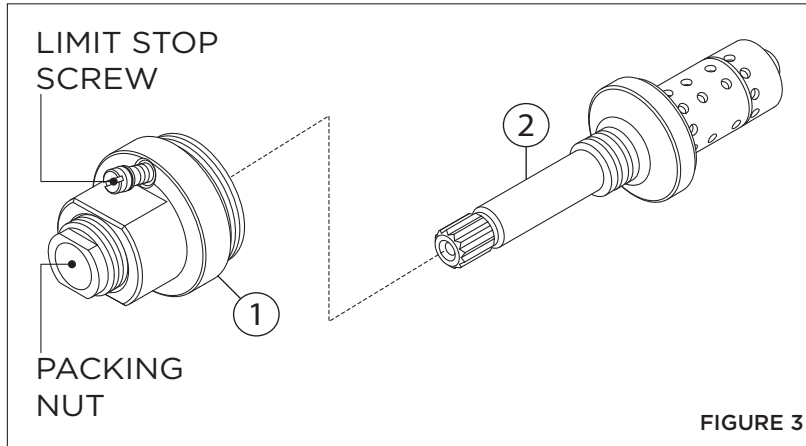

Replacement Parts		
Item	Description	Part Number
1	Cap Assy.	T-12A
2	Flow Control Spindle	TA-10

IMPORTANT: Model numbers ending in **TRMTC** coordinate with Temptrol pressure balancing valves ordered with Test Cap. The Test Cap is used to allow pressurization of system. **Do not** remove test cap from valve during wall construction, installation of valve or pressurization of system.

4. Installation - Remove Test Cap (Model Numbers Ending in TRMTC)

Flow control spindle (TA-10) and cap assembly (T-12A) will come factory assembled for all model numbers ending in **TRMTC**. When ready to remove Test Cap and install trim, follow the instructions below:

- 1) Check for leaks around the valve assembly and all pipe fittings.
- 2) Remove test cap from valve (FIGURE 4.1).
- 3) If system is dirty, flush valve.
- 4) Thread flow control spindle and cap assembly into valve body. Turn clockwise to secure to valve (FIGURE 4.2).

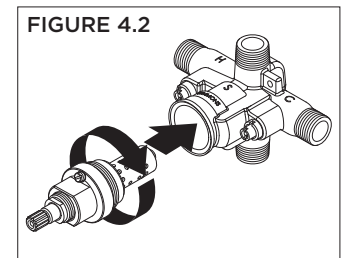
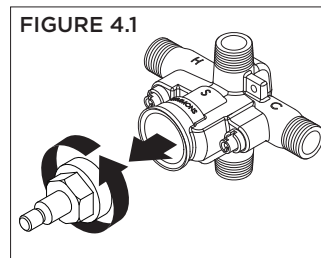

5. Installation - Adjust Packing Nut (Model Numbers Ending in TRMTC)

- 1) Turn hot and cold supplies on. Valve will not operate unless both hot and cold water supply pressures are on.
- 2) Place handle over flow control spindle.
- 3) Tighten packing nut for positive frictional resistance as handle is rotated from shut-off position across adjustment range.

6. Installation - Setting Limit Stop Screw (Model Numbers Ending in TRMTC)

The temperature limit stop screw limits valve handle from being turned to maximum position resulting in excessive hot water discharge temperatures.

⚠ WARNING: Failure to adjust limit stop screw properly may result in serious scalding.

- 1) Turn hot and cold supplies on. Valve will not operate unless both hot and cold water supply pressures are on.
- 2) Place handle on flow control spindle and open valve to maximum desired temperature.
- 3) Turn limit stop screw clockwise until it seats.

7. Parts Breakdown

FIGURE 7

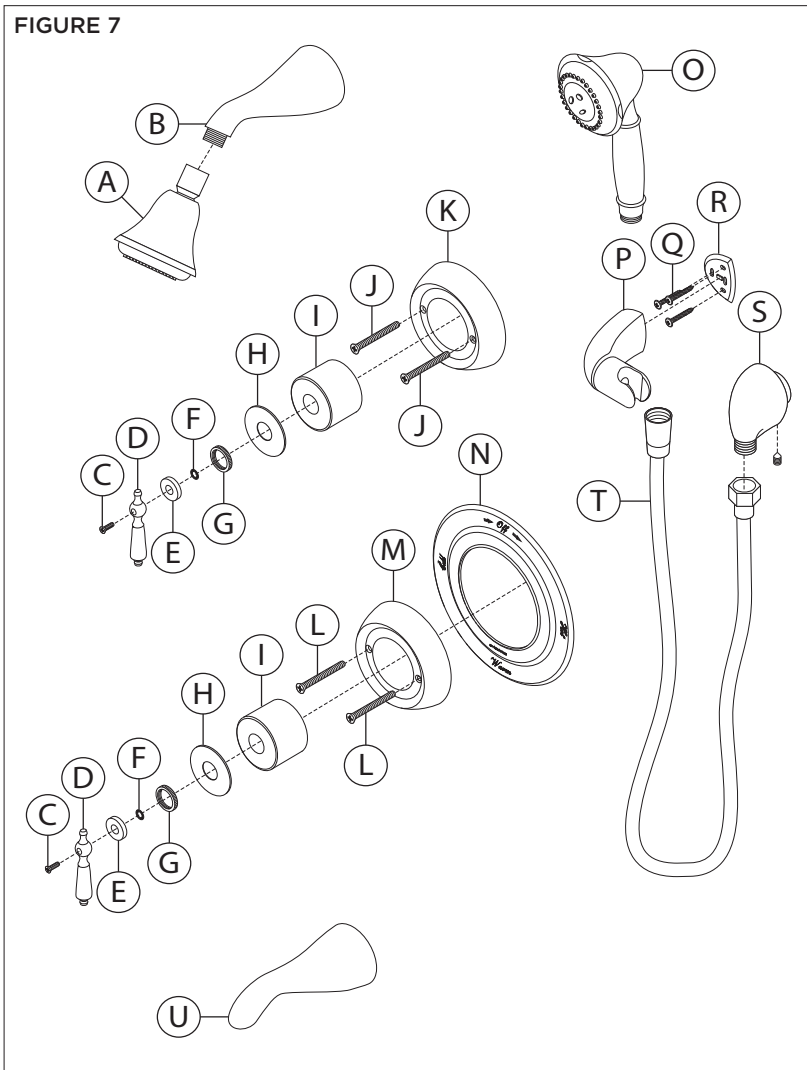

Replacement Parts		
Item	Description	Part Number
A	Showerhead	442SH
B	Shower Arm	304
C	Set Screw	DF-28-LPO
D	Handle	
E	Flange	
F	O-ring	
G	Lock Nut	T-20-PL
H	Washer	40B-PL
I	Dome Cover	DF-11
J	Mounting Screws	DF-14
K	Diverter Escutcheon	
N	Shower Plate	7.5-ETCH
O	Hand Shower	442W
P	Wall Cradle	EF-106
Q	Screws	
R	Mounting Plate	
S	Wall Elbow	EF-105
T	60" Hose	RTS-045
U	Tub Spout	063

Notes:

- 1) Append appropriate suffix for premium finish.
- 2) Append appropriate flow rate to showerhead or hand shower for low flow.
- 3) Apply a bead of silicone around the perimeter of all shower trim installed flush to the finished wall. Leave opening on bottom of escutcheons for weep hole.
- 4) Apply plumber tape to all threaded connections.



*Order in-line vacuum breaker (EF-109) for hand shower systems without dual checks.

8. Installation - Shower Valve Trim

- 1) Secure escutcheon and shower plate to Temptrol pressure balancing valve using mounting screws (FIGURE 8.1).
- 2) Install dome cover and washer to valve. Secure with lock nut by turning clockwise (FIGURE 8.2).
- 3) Place o-ring in groove under spindle broach. Install flange and handle to shower valve. Secure with screw (FIGURE 8.3).

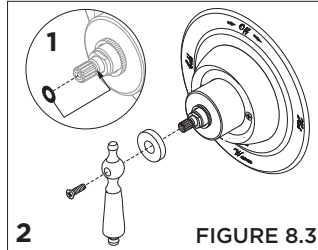
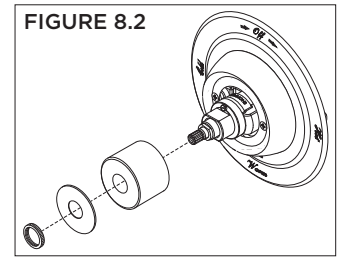
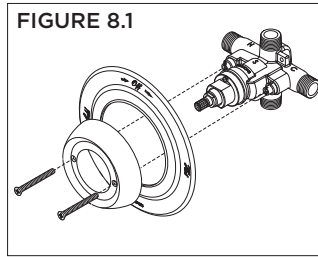

9. Installation - Diverter Valve Trim

- 1) Secure escutcheon to Symmons diverter valve using mounting screws (FIGURE 9.1).
- 2) Install dome cover and washer to valve. Secure with lock nut by turning clockwise (FIGURE 9.2).
- 3) Place o-ring in groove under spindle broach. Install flange and handle to diverter valve. Secure with screw (FIGURE 8.3).

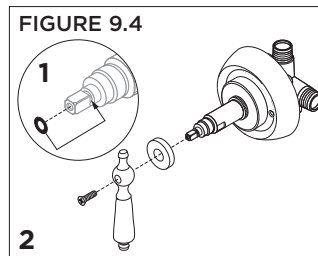
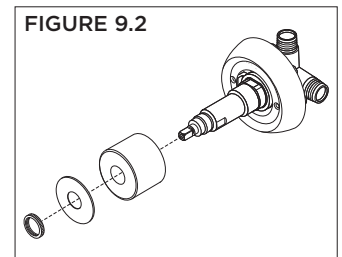
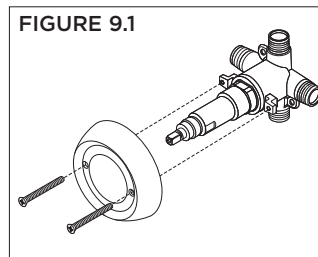

10. Installation - Showerhead & Tub Spout

- 1) Attach shower arm to stub out pipe. Turn clockwise to tighten (FIGURE 10.1).
- 2) Install showerhead to shower arm. Turn clockwise to tighten (FIGURE 10.2).
- 3) Install tub spout to stub out pipe. Turn clockwise to tighten (FIGURE 10.3).

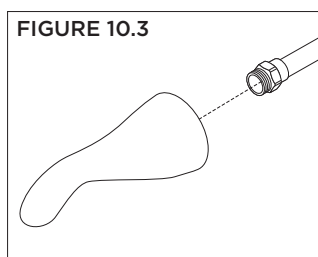
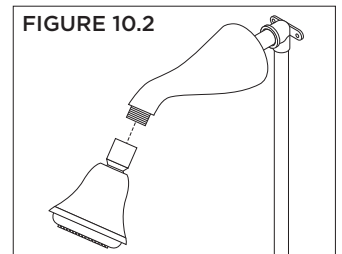
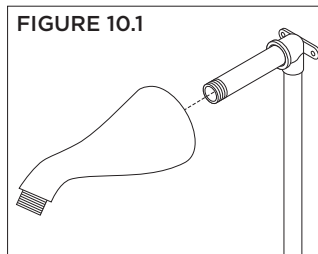

11. Installation - Slide Bar Assembly

1) Place mounting plate in position. Mark and drill $3/16''$ holes for tile anchors, $5/16''$ holes for drywall anchors. Install anchors (FIGURE 11.1).

Note: For dry wall $1/2''$ thick or less, insert anchor tool into drywall anchor to secure behind wall prior to installing wall cradle.

2) Remove cover of hand shower cradle. Install cradle and mounting plate. Secure with three screws. Replace cover on hand shower cradle (FIGURE 11.2).

3) Install wall elbow to stub out pipe. Tighten set screw to secure (FIGURE 11.3).

4) Attach small end of hand shower hose to wall elbow. Turn clockwise to tighten (FIGURE 11.4).

5) Attach large end of hand shower hose to hand shower wand. Turn clockwise to tighten (FIGURE 11.5).

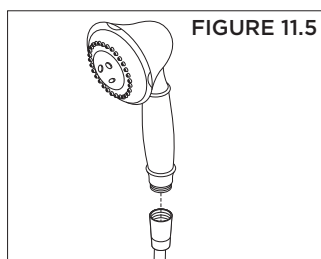
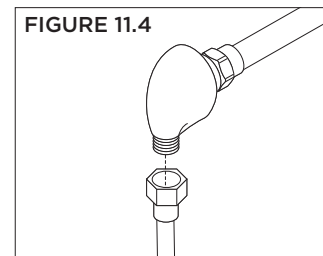
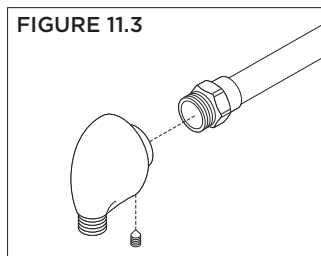
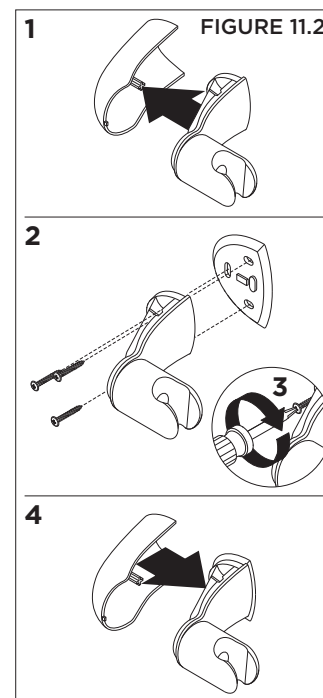
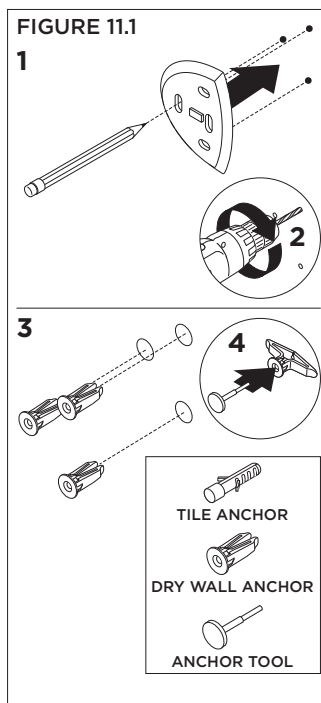

12. Operation (Temperature Control)

- 1) Turn shower handle counter-clockwise approximately 1/4 turn to put valve in cold position (FIGURE 12.1).
- 2) Turn shower handle counter-clockwise approximately 1/2 turn to put valve in warm position (FIGURE 12.2).
- 3) Turn shower handle counter-clockwise approximately 3/4 turn to put valve in hot position (FIGURE 12.3).

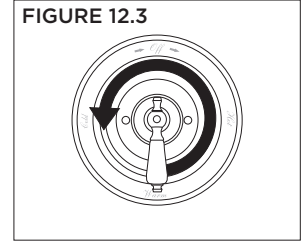
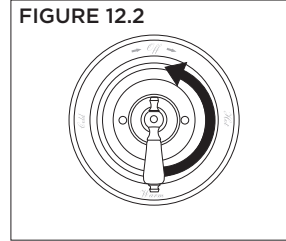
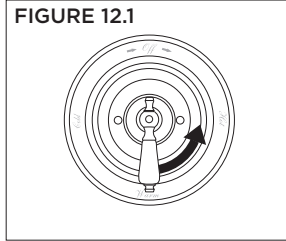

13. Operation (Dual Outlet Diverter Control)

Note: Additional handle positions for same output are illustrated.

- 1) Cartridge is factory set to divert to function 1 (FIGURE 13.1).
- 2) Turn handle to position 2 to divert to function 2 (FIGURE 13.2).
- 3) Turn handle to position 3 to share functions 1 and 2 (FIGURE 13.3).

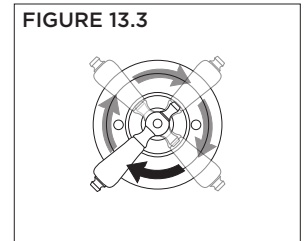
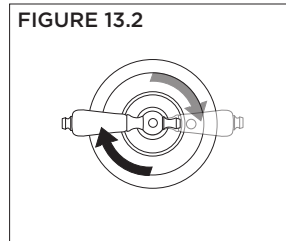
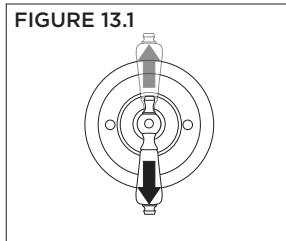

14. Operation (Triple Outlet Diverter Control)

- 1) Cartridge is factory set to divert to function 1 (FIGURE 14.1).
- 2) Turn handle to position 2 to divert to function 2 (FIGURE 14.2).
- 3) Turn handle to position 3 to divert to function 3 (FIGURE 14.3).
- 4) Turn handle to position 4 to share functions 2 and 3 (FIGURE 14.4).
- 5) Turn handle to position 5 to share functions 1 and 3 (FIGURE 14.5).
- 6) Turn handle to position 6 to share functions 1 and 2 (FIGURE 14.6).

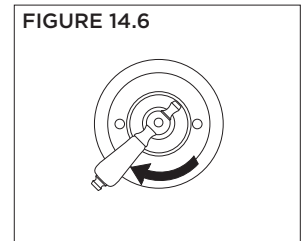
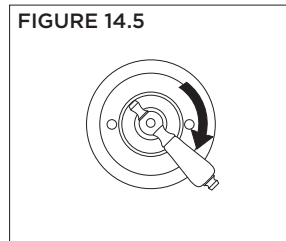
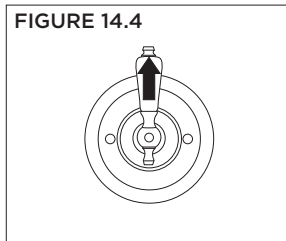
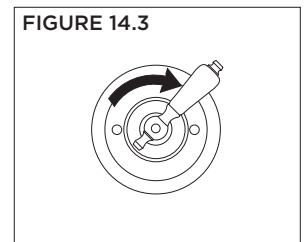
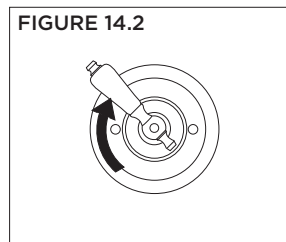
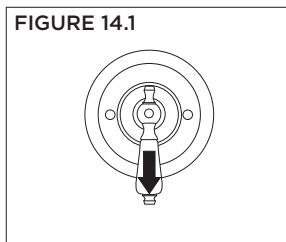

15. Troubleshooting Chart

Problem	Cause	Solution
Finish is spotting.	Elements in water supply may cause water staining on finish.	Clean finished trim area with a soft cloth using mild soap and water or a non-abrasive cleaner and then quickly rinse with water.

 **WARNING:** This product can expose you to chemicals including lead, which is known to the state of California to cause cancer, birth defects, or other reproductive harm. For more information, go to www.P65Warnings.ca.gov.