

**352SH, 352SH-3**  
**Showerhead Series**  
**Operation & Maintenance Manual**



<b>Model Number</b>	<b>Specification</b>
<input type="checkbox"/> <b>352SH</b> <i>1 Mode Showerhead</i> <input type="checkbox"/> <b>352SH-3</b> <i>3 Mode Showerhead</i>	<ul style="list-style-type: none"> <li>• 1 mode showerhead (352SH)</li> <li>• 3 mode showerhead (352SH-3)</li> <li>• 3" diameter</li> <li>• Easy to clean rubber nozzles</li> <li>• 2.5 gpm (9.5 L/min) standard flow restrictor</li> </ul>
<b>Modifications</b>	<b>Compliance</b>
<input type="checkbox"/> <b>-1.5</b> <b>CG</b> <i>1.5 gpm (5.7 L/min) flow restrictor</i> <input type="checkbox"/> <b>-2.0</b> <i>2.0 gpm (7.6 L/min) flow restrictor</i>	<ul style="list-style-type: none"> <li>- ASME A112.18.1/CSA B125.1</li> <li>- WaterSense 1.5 gpm, 2.0 gpm</li> </ul> 
	<b>Warranty</b>  <p><b>Limited Lifetime</b> - to the original end purchaser in consumer installations.  <b>5 Years</b> - for commercial installations.  Refer to <a href="http://www.symmons.com/warranty">www.symmons.com/warranty</a> for complete warranty information.</p>

**Note:** Append appropriate -suffix to model number.

**Dimensions**

**352SH**

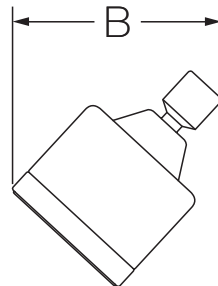
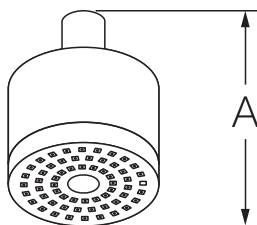

**352SH-3**

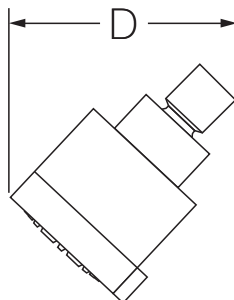
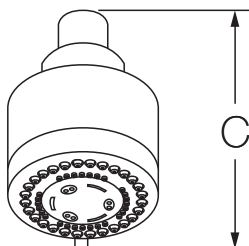

Measurements	
A	4-1/4", 108 mm
B	4-1/8", 105 mm
C	4-3/4", 121 mm
D	4-1/2", 114 mm

**Note:** Dimensions subject to change without notice.

## Installation

### Tools Required for Installation

Plumber Tape



- 1) Install showerhead to shower arm (not included) turning clockwise to tighten.

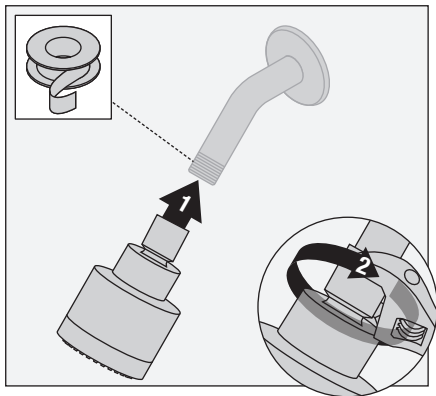

## Operation

- 1) Turn showerhead to desired mode of operation.

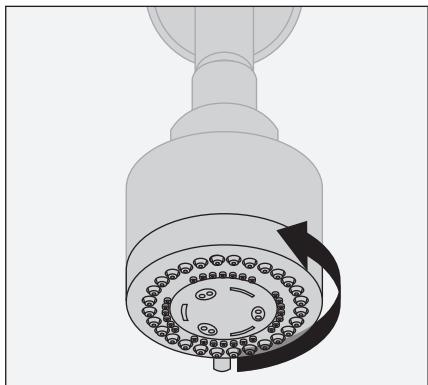

## Troubleshooting Chart

Problem	Cause	Solution
Finish is spotting.	Elements in water supply may cause water staining on finish.	Clean finished trim area with a soft cloth using mild soap and water or a non-abrasive cleaner and then quickly rinse with water.
Showerhead is leaking from shower arm when valve is in "on" position.	Coupling connecting showerhead to shower arm is cracked.	Inspect coupling and replace showerhead if necessary.