



SYMMONS® DS Creations

the smart choice™

0707-GSH-15 (CD0707-3GSH-15)

15" Wall Mounted Glass Shelf

Installation Guide

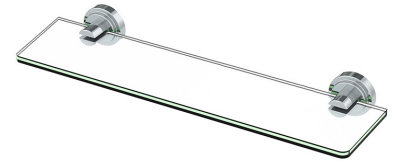

Model Numbers	Specification
<input type="checkbox"/> 0707-GSH-15 <i>15" Wall Mounted Glass Shelf</i>	15" Wall Mounted Glass Shelf shall be made from metal and tempered glass construction. Metal trim shall be plated in standard polished chrome finish.
Warranty Limited Lifetime - to the original end purchaser in consumer/residential installations. 5 Years - for industrial/commercial installations. Refer to www.symmons.com/warranty for complete warranty information.	

Dimensions

Measurements	
A	15", 381 mm
B	11", 279 mm
C	(2x) Ø 1-7/8", 48 mm
D	1-3/4", 44 mm
E	4-1/2", 114 mm

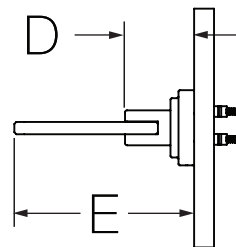
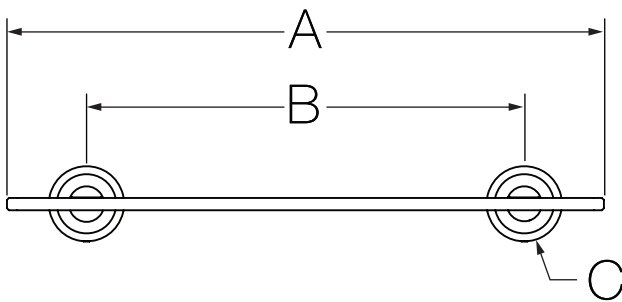

Note: Dimensions subject to change without notice.

Parts Breakdown

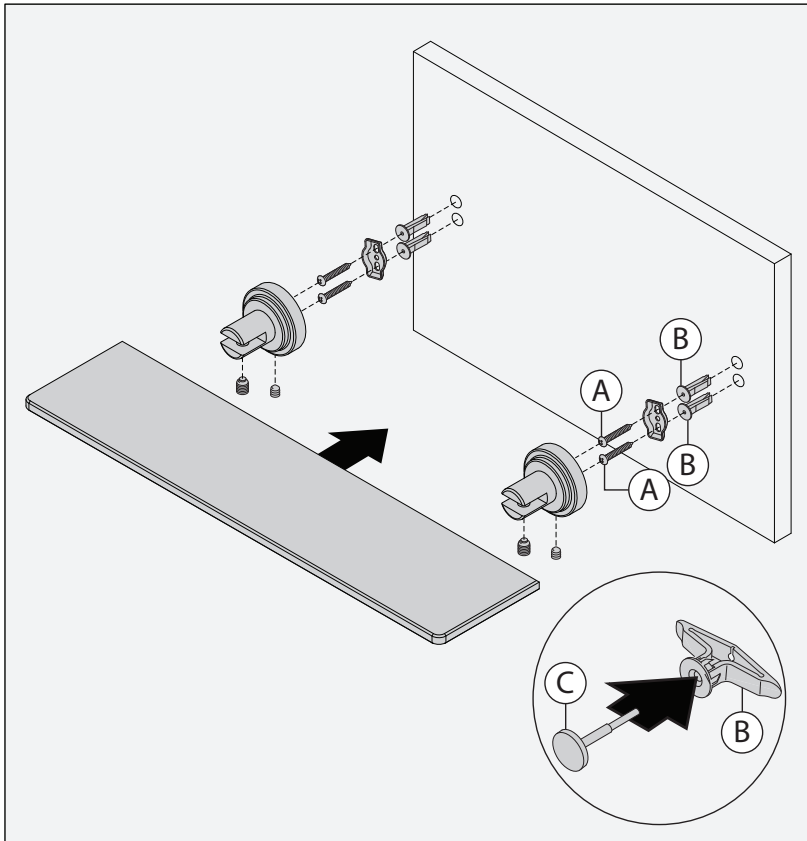

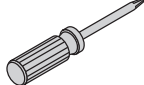
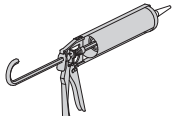
Replacement Parts		
Item	Description	Part Number
A	Mounting Screws	HW-03141
B	Drywall Anchors	
C	Anchor Tool	
Tools Required for Installation		
Allen Wrench: Trim (2.5 mm) Shelf (4 mm)		
Phillips Head Screwdriver		
Silicone		

Notes:

- 1) For drywall 1/2 inch thick or less, insert anchor tool (C) into drywall anchor (B) to secure behind wall prior to installing trim.
- 2) Apply a bead of silicone around the perimeter of trim installed flush to finished wall.

⚠ WARNING: This product can expose you to chemicals including lead, which is known to the state of California to cause cancer, birth defects, or other reproductive harm. For more information, go to www.P65Warnings.ca.gov.