



SYMMONS® DS Creations

the smart choice™

0630-DRH (CD0630-363DRH)

Double Robe Hook

Installation Guide

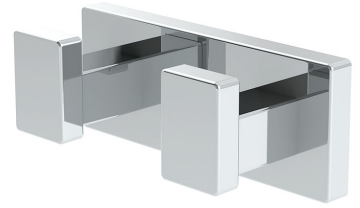

Model Numbers	Specification
<input type="checkbox"/> 0630-DRH <i>Double Robe Hook</i>	Double Robe Hook shall be made from metal construction, plated in standard polished chrome finish.
Warranty	
<p>Limited Lifetime - to the original end purchaser in consumer/residential installations.</p> <p>5 Years - for industrial/commercial installations.</p> <p>Refer to www.symmons.com/warranty for complete warranty information.</p>	

Dimensions

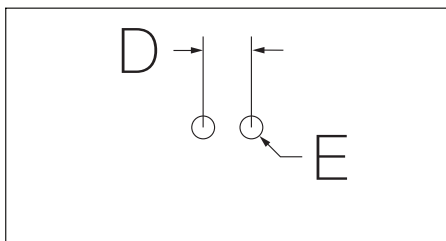
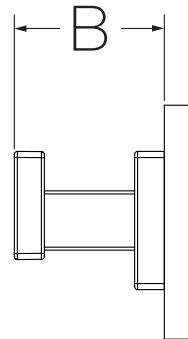
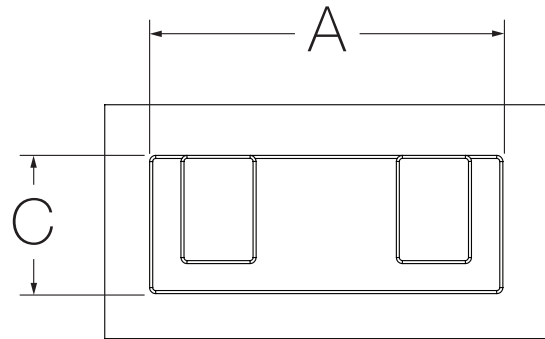

Measurements	
A	4-5/8", 117 mm
B	2", 51 mm
C	1-7/8", 47 mm
D	11/16", 17 mm
E	(2x) Hole Size Ø 5/16", 8 mm

Note: Dimensions subject to change without notice.

Parts Breakdown

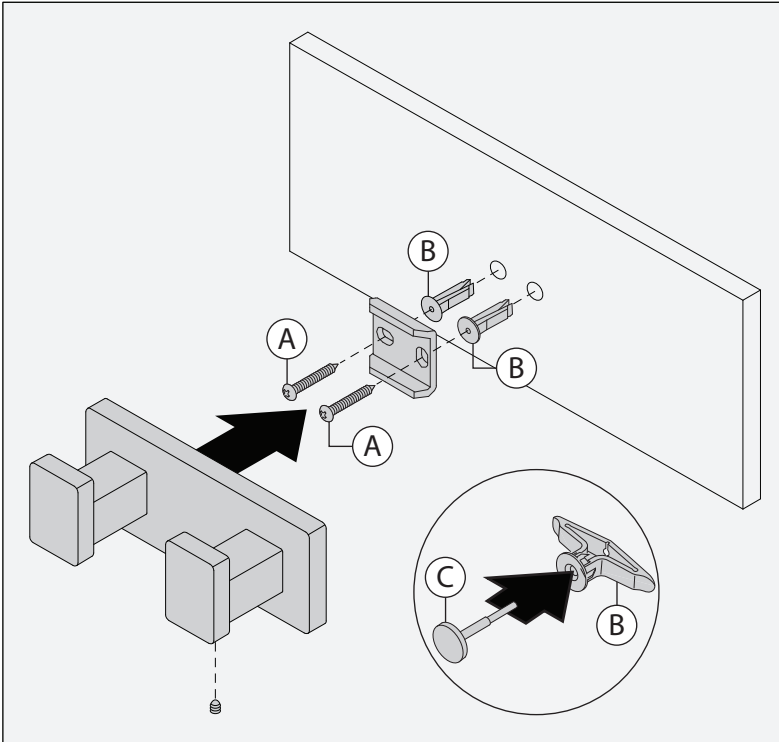

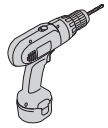
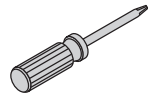
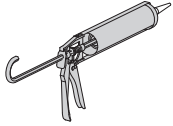
Replacement Parts		
Item	Description	Part Number
A	Mounting Screws	HW-03141
B	Drywall Anchors	
C	Anchor Tool	
Tools Required for Installation		
Allen Wrench: 2.5 mm		
Drill		
Phillips Head Screwdriver		
Silicone		

Notes:

- 1) For drywall 1/2 inch thick or less, insert anchor tool (C) into drywall anchor (B) to secure behind wall prior to installing trim.
- 2) Apply a bead of silicone around the perimeter of trim installed flush to finished wall.

⚠ WARNING: This product can expose you to chemicals including lead, which is known to the state of California to cause cancer, birth defects, or other reproductive harm. For more information, go to www.P65Warnings.ca.gov.