



INSTALLATION MANUAL

ASTM TUBE / FITTING SYSTEMS / SOLUTIONS

- » PowerPEX ASTM F1807 Crimp™
- » PowerPEX ASTM F2159 AccuCrimp™
- » PowerPEX ASTM F2080 Lock™
- » PowerPEX ASTM F1960 Grip™



Tubing

PowerPEX Tubing

Fitting Systems

Tools & Accessories

Installation Guidelines

Certifications & Listings

Warranty



PowerPEX[®]

INSTALLATION

MANUAL

» Introduction

This manual covers the specifications and installation guidelines for Sioux Chief's full line of PowerPEX[®] tube and PEX fitting systems. The manual describes all of the various ASTM PEX product standards, and how Sioux Chief's PowerPEX products are installed per those standards.

All product or system installations shall adhere to the procedures and guidelines within. Nothing within is intended to establish a warranty beyond Sioux Chief's expressed warranty. Check with all local codes prior to installation.



TABLE OF CONTENTS

1 Tubing

1.1 Explaining PEX Tube
PG 04

2 PowerPEX Tubing

2.1 Sioux Chief PowerPEX Tube Types,
Availability & System Compliance
PG 05

2.2 PowerPEX Identification & Testing
PG 06

2.3 PEX Tubing Product Standards & Code Compliance
PG 08

2.4 Material Benefits & Properties
PG 09

3 Fitting Systems

3.1 ASTM F1807 Crimp Installations & Application Problems
PG 13

3.2 ASTM F2159 AccuCrimp Installations & Application Problems
PG 15

3.3 ASTM F1807 or F2159 with ASTM F877 V-Sleeve
Installations & Application Problems
PG 17

3.4 ASTM F2080 Lock Installations & Application Problems
PG 19

3.5 ASTM F1960 Grip Installations & Application Problems
PG 21

4 Tools & Accessories

4.1 PEX Accessories, Gauging & Tool Tips
PG 23

4.2 Copper Crimp Ring & V-Sleeve Stainless Steel Sleeve
PG 24

4.3 F1807/F2159 with V-Sleeve Tool Repair/Calibration
PG 25

4.4 ASTM F2080 Lock Tools
PG 26

4.5 ASTM F1960 Grip Tools
PG 27

5 Installation Guidelines

5.1 Hybrid Systems/Combination Install
PG 28

5.2 System Installation Options
PG 30

5.3 Manifold Plumbing
PG 31

5.4 Tubing Installation Requirements & Limitations
PG 33

5.5 Avoiding Common Problems
PG 39

6 Certifications & Listings

7 Warranty & Terms of Use

»» What is PowerPEX?

Sioux Chief offers all major PEX systems. Sioux Chief's PEX offering is the most complete in the plumbing industry. All fitting and tube solutions carry a 25-year warranty, mixed or matched. Sioux Chief does not limit its warranty on tube or fittings based on matching system connections when they are made and installed in compliant tube & fitting assemblies.

PowerPEX gives contractors the ability to choose the right tube or fitting connection for each application, layout or contractor comfort level. We call this Fitting Freedom™. Sioux Chief believes intelligent systems may incorporate hybrid PEX offerings to maximize each connection system's benefit. This Power to Choose™ puts the plumber back at the heart of smart plumbing.

PEX tubing is an economical and cost-effective construction tubing material. Manufacturing PEX tube consumes less energy than manufacturing metallic tube. The lighter weight of PEX helps to lower transportation costs and the wear-and-tear on the installer. The ability to coil PEX decreases the overall footprint of storage and handling thereby saving space. PEX can be installed in ways to reduce the overall fittings used which reduce the possibility of a leak. PEX can help reduce system noise by eliminating sharp bends and fittings in a wall and reduces hot water wait times through manifolding installation practices.



Tubing

» Explaining PEX Tubing

This section explains PEX Tubing, including manufacturing methods, PEX tube markings, product standards and model codes and material properties.

Additionally, some common installations utilizing PEX tubing are listed by installation application.

What is PEX Tubing

PEX is cross-linked polyethylene. Through one of several processes, links between polyethylene molecules are formed to create bridges (thus the term “cross-linked”). This resulting material is more durable under temperature extremes, chemical attack, and better resists creep deformation, making PEX an excellent material for potable water and other applications. The physical properties of PEX tubing make it ideal for use with various mechanical connection systems.

PEX Tubing Applications

PEX is ideally suited for potable water plumbing applications. It is flexible, making it easy to install and service. PEX is able to withstand the high and low temperatures found in plumbing and heating applications and is highly resistant to chemicals found in the plumbing environment.

Common Application Types:

- Water service
- Potable water plumbing
- Hydronic / radiant cooling
- Hydronic / radiant heating*
- Snow / ice melting systems*
- Turf conditioning systems
- Permafrost systems
- Water reclamation
- Fire suppression**
- Mixed (plumbing + fire suppression, etc.)
- No Lead systems
- Geothermal
- Dezincification resistant systems

* Special system component consideration and elimination of ferrous components must be made for radiant or snow melt systems when using non-barrier tubing.

** Check with local codes and applicable requirements.

Manufacturing Methods

There are three primary methods for producing PEX tubing.

PEX-A | The “Engel” or peroxide method.

Peroxide is added to the base resin and through a combination of pressure and high temperature the cross-linking takes place as the tubing is produced.

PEX-B | The “Silane” method.

Silane is grafted to the backbone of the polyethylene. The grafted compound is combined with a catalyst through the Sioplas or Monosil methods. Extruded tube is exposed to steam or hot water to complete the cross-linking reaction. The resultant link is three-dimensional in nature whereby the bunch-like bond is not unlike a trellis.

PEX-C | Electron Beam method.

Very high-energy radiation is used to initiate molecular cross-linking in specialty high-density polyethylene. Tube is extruded (generally as HDPE), routed through an E-Beam facility and rotated under a beam in the accelerator where it is dosed with a specific amount of radiation to release the hydrogen atoms and cause polymer chains to link to the open carbon sites. The resultant link is planar in nature and a carbon to carbon bond.

PowerPEX[®] Tubing

Flexible, Durable, Quality Tubing – Made in America 

Sioux Chief PowerPEX - PEX-A

Sioux Chief PEX-A tube is made using the Engel process described earlier where heated extrusion of a specialty PE resin containing a high concentration of organic peroxide creates PEX. As the peroxide decomposes, bonds on the polyethylene chains are formed.

Sioux Chief PowerPEX - PEX-B

Sioux Chief PEX-B tube is made using the Sioplas method described earlier. This involves a 2 component extrusion with the base material comprising 95% of the end product and the catalyst to start the reaction accounting for the remaining 5%. The reaction begins at extrusion and is accelerated by curing at elevated temperatures and with moisture exposure.

PowerPEX Tubing

TUBE SIZE	STANDARD	DESIGNATION CODE & TUBE TYPE	
Non-Barrier Tube			
1/2"	ASTM F876/F877	5306 (PEX-B)	3006 (PEX-A)
3/4"	ASTM F876/F877	5306 (PEX-B)	3006 (PEX-A)
1"	ASTM F876/F877	5306 (PEX-B)	3006 (PEX-A)
1 1/4"	ASTM F876/F877	5306 (PEX-B)	
1 1/2"	ASTM F876/F877		3306 (PEX-A)
2"	ASTM F876/F877		3306 (PEX-A)
Oxygen Barrier Tube			
1/2"	ASTM F876/F877	5306 (PEX-B)	1006 (PEX-A)
3/4"	ASTM F876/F877	5306 (PEX-B)	1006 (PEX-A)
1"	ASTM F876/F877	5306 (PEX-B)	1006 (PEX-A)

PowerPEX Fitting Size Availability

	3/8"	1/2"	3/4"	1"	1 1/4"	1 1/2"	2"
F1807 Crimp	■	■	■	■	■		
F877 Crimp						■	■
F2159		■	■	■			
F877 Crimp					■	■	■
F1960 Grip		■	■	■	■	■	■

PowerPEX Tube & Fitting System Compliance

	PEX-B TUBING	PEX-A TUBING	BARRIER PEX-B	BARRIER PEX-A
F1807 Crimp	■	■	■	■
F877 Crimp	■	■	■	■
F2159 Crimp	■	■	■	■
F877 Crimp	■	■	■	■
F1960 Grip	■	■	■	■



ASTM
F1807 / F2159



ASTM
F1960



ASTM
F3348



ASSE
1061

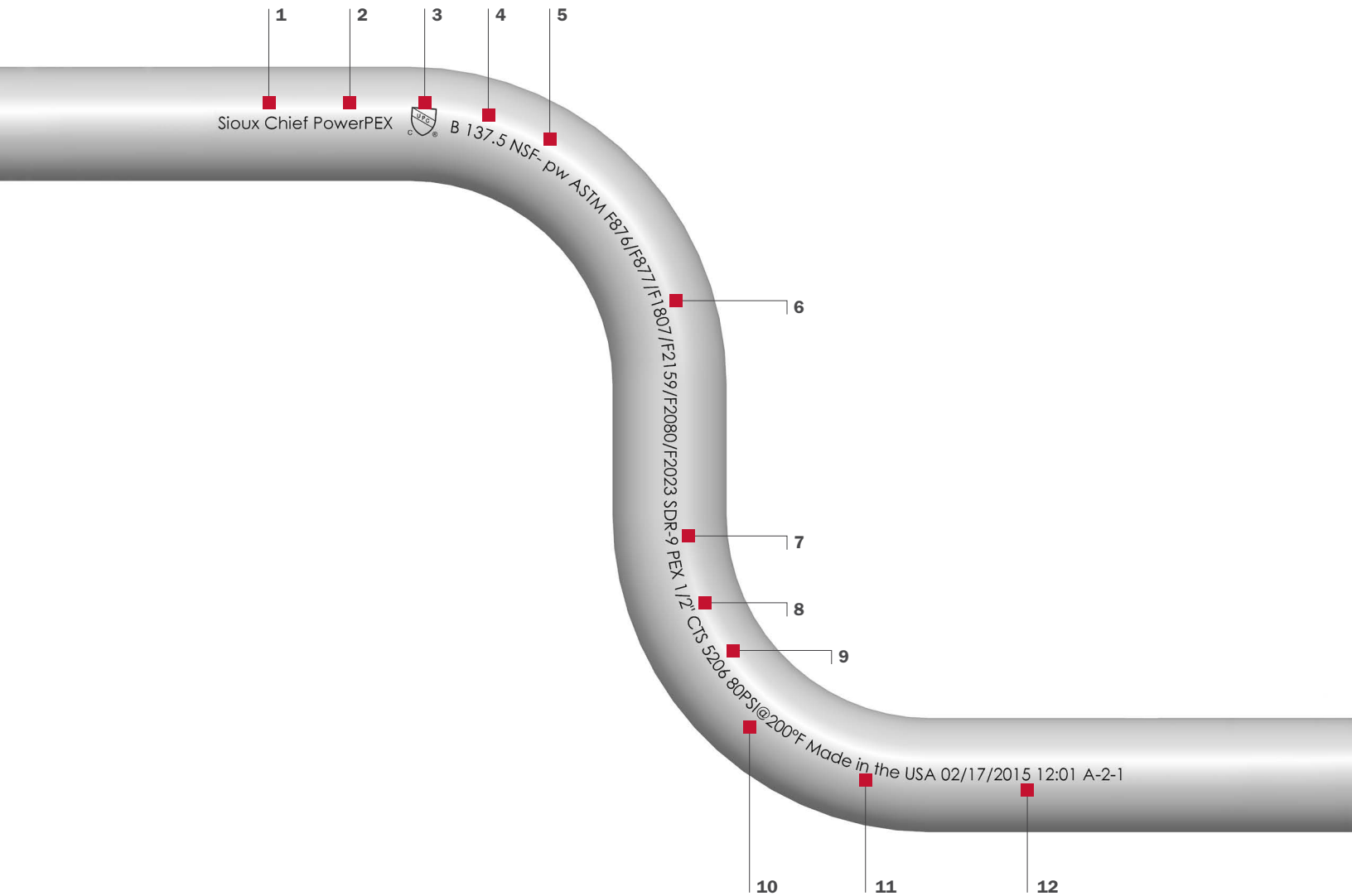

Sioux Chief PowerPEX Markings – PowerPEX PEX-B

PRINTED MARKINGS ON TUBING		EXPLANATION
1	Sioux Chief	Company Name
2	PowerPEX	Product Name
3	cUPC	CSA Listing & Canadian Certification
4	B137.5	IAPMO Listing = Model Plumbing Code Body
5	NSF-pw	National Sanitation Foundation Mark for Toxicity & Performance Certification
6	ASTM F876/F877/F1807/F2159/F2080	Applicable ASTM Standard Certifications for Performance & Manufacturers
7	SDR9 PEX	Standard Dimensional Ratio For Fitting Size Acceptance
8	1/2" CTS	Tubing Size
9	5206	Chlorine & UV Resistance Per Standard
10	160PSI@73.4°F / 100PSI@180°F / 80PSI@200°F	Pressure & Temperature Rating (tube will include sample. See pg. 10 for full spec)
11	Made in the USA	Country of Origin
12	02/17/2015 12:01 A-2-1	Date Stamp, Time Stamp & Manufacturer's Line Tracking Number

PEX Type: Chlorine Resistance and UV Inhibition

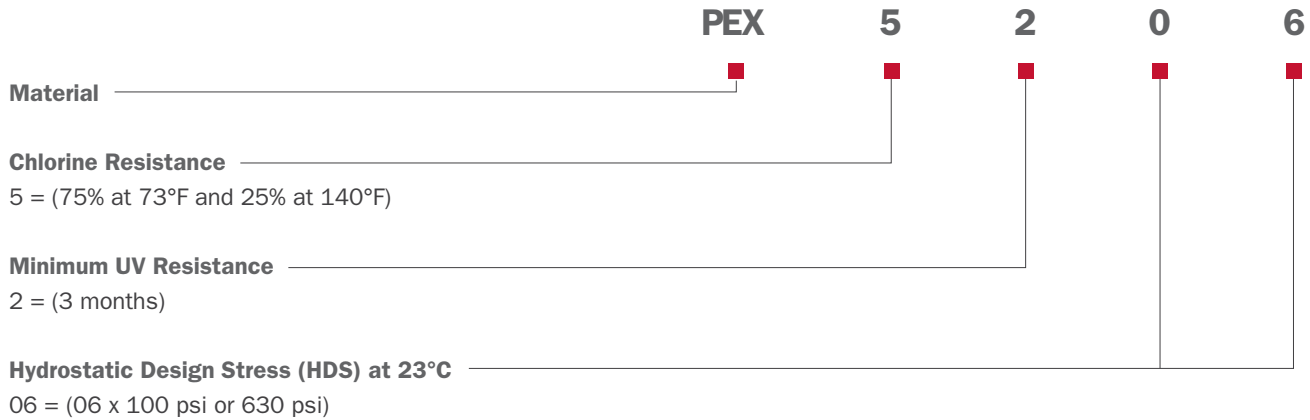

Tube Type Identification Mark Example: 5206 or 1006

Integer 1: (chlorine resistance) PER ASTM F2023

- 0 = Not tested for Chlorine resistance
- 1 = 25% use @ 140°F
& 75% use @ 73°F
- 3 = 50% use @ 140°F
& 50% use @ 73°F
- 5 = 100% use @ 140°F

Integer 2: (min. UV resistance) PER ASTM F2657

- 0 = Not tested for UV exposure
- 1 = Max. exposure of 1 month
- 2 = Max. exposure of 3 months
- 3 = Max. exposure of 6 months

Integer 3&4: (HDS @ 73°F) × 100 psi.

- 06 = 630 psi.

Sioux Chief PowerPEX Production Tests and Continuous Compliance Tests

TEST	STANDARD	FREQUENCY
Density	ASTM D1505	Each Tubing Run
Hydrostatic Sustained Pressure	ASTM D1598	Random Continuous Samples
Hydrostatic Burst Pressure	ASTM D1599	Each Tubing Run
Environmental Stress Cracking	ASTM F876	Annually
UV Inhibition	ASTM F2657	During Certification
Degree of Cross-linking	ASTM D2765	Each Tubing Run
Stabilizer Functionality	ASTM D1598	During Certification
Oxidative Stability	ASTM F2023	During Certification
Bent Tube Sustained Pressure	ASTM D1598	Annually
Excessive Temp + Pressure Capability	ASTM D1598	Each Random Continuous Samples
Melt Flow Index	ASTM D1238	Each Receipt
Ongoing Dimensional Checks (OD, ID, Wall Thickness, Homogeneity, Etc.)	ASTM F876/877	Continuous
Ongoing Dimensional Checks - Fittings (Copper, Brass, Plastic)	ASTM FITTING STANDARD	Each Run
Rockwell Tests for Copper Crimp Rings	ASTM F1807	Each Run
Alloy Material Test (X-Ray Florescence Analyzer)	ASTM FITTING STANDARD	Each Receipt
Certificate of Resin Compliance	PER MSDS SHEET	Each Receipt
Crush Test (for PPSU Fittings)	ASTM F2159	Random Continuous Samples

PEX Tubing Product Standards

ASTM F876: Standard Specification for Cross-linked Polyethylene (PEX) Tubing

ASTM F877: Standard Specification for Cross-linked Polyethylene (PEX) Hot and Cold-Water Distribution Systems

CSA B137.5: Cross-linked Polyethylene (PEX) Tubing Systems for Pressure Applications

Code Acceptance

PEX Tubing Code Compliance. Below is a list of commonly referenced and recognized plumbing model codes, which recognize PEX tubing installation and reference standards for application and installation compliance. Individual standards can be referenced in section 6.

Area / Region. Many cities, states, counties or other jurisdictions may employ and determine what standards, specifications, and plumbing/heating practices are satisfactory. Check with all local and state codes prior to any installation.

IPC
International
Plumbing Code

IRC
International
Residential Code

UPC
Uniform
Plumbing Code



Sioux Chief utilizes the most state-of-the-art extrusion equipment and facility to manufacture, inspect, stock, ship and service PEX-B tubing to the plumbing and radiant heating industries from their Missouri headquarters.

Depicted:
Sioux Chief extrusion lines in Peculiar, Missouri.

Material Benefits of PEX Tubing

Corrosion Resistant. Smooth inner walls, inhibit mineral build up and scaling. PEX is also more resistant to the harmful effects of abrasive chemicals such as chlorine. PEX tube resists pitting or stress-corrosion more than other tubing types.

Quiet. Flow characteristics are increased and system noise is decreased when compared to metal tubing systems.

Freeze Resistant. While it is always recommended to follow code requirements and common practices to protect from freezing, PEX tubing can expand and contract more easily (often without damage) than copper and CPVC tubing.

Reduced Turbulence / Increased Flow. The smooth interior wall of the tube reduces turbulence during water demand thereby increasing the overall flow characteristics to the fixture being supplied.

Thermal Conductivity. PEX tube allows less heat transfer compared to metal tube, saving energy and money.

Installation Flexibility. PEX tube bends easily and can be easily plumbed around building members or through floors/walls. Bending tube behind walls and stubbing out with PEX reduces the overall fittings used, brackets needed, joints behind the wall, labor to install and liability of leaks.

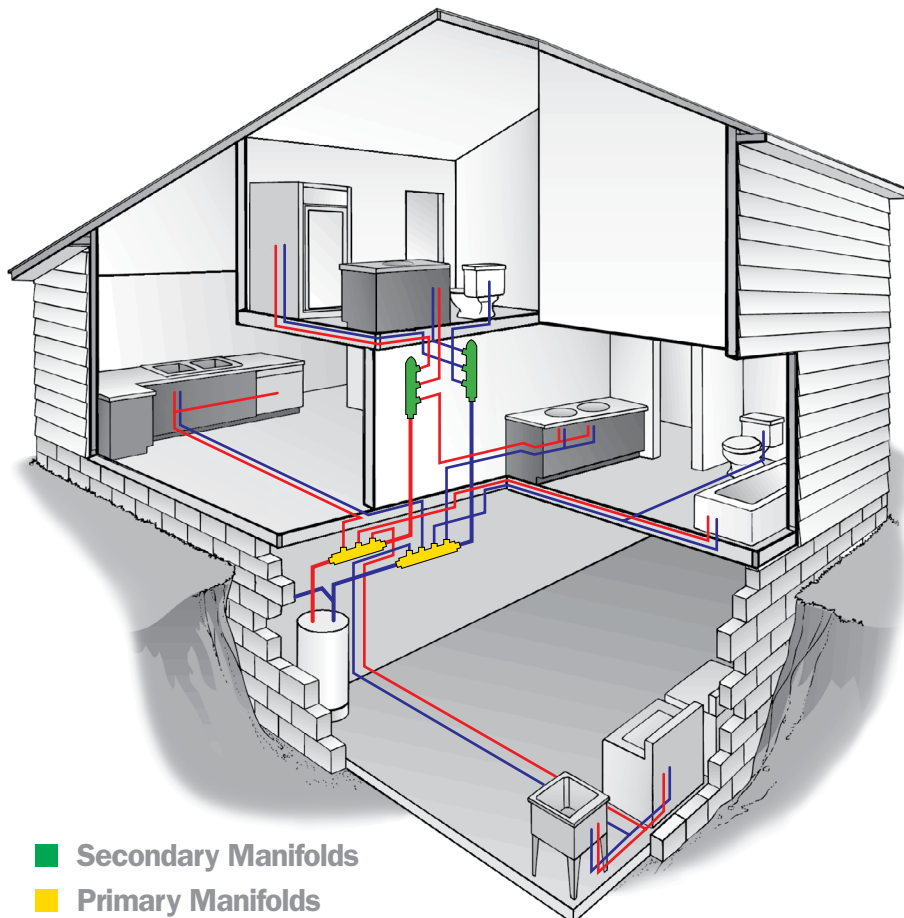

PEX Installation Tips

- When servicing a line, Sioux Chief recommends using valved manifolds whenever possible. Primary manifolds should always be valved.
- Branchmaster manifolds can always be coupled together with other manifolds and PEX tube to achieve the desired number of branches.

Material Properties of PEX Tubing

Water Temperature + Water Pressure. PEX tubing shall not be used in applications where temperature and pressure ratings are not regulated or are known to evidence exposures beyond the tested and certified limit of the tube.

Operating Pressure / Temperatures

TEMPERATURE	HYDROSTATIC PSI (MAX)	OPERATING PSI WATER
73.4° F / 23° C	630	160
180° F / 82.2° C	400	100
200° F / 93.3° C	315	80

Minimum Bend Radius*

TUBE SIZE (CTS)	BEND RADIUS
1/2"	3.75"
3/4"	5.25"
1"	6.75"
1-1/4"	8.25"
1-1/2"	9.75"
2"	12.75"

*Additional information found within PowerPEX tubing limitations

Flow Characteristics

GPM	1/2" PRESSURE DROP @ 60°F (PSI/100FT)	VELOCITY (FT/SEC)	3/4" PRESSURE DROP @ 60°F (PSI/) 100FT	VELOCITY (FT/SEC)	1" PRESSURE DROP @ 60°F (PSI/100FT)	VELOCITY (FT/SEC)
1	1.8	1.7	1.2	1.8	.4	1
2	5.9	3.5	2.4	2.7	.7	1.6
3	12.1	5.2	4.0	3.5	1.2	2.1
4	20.1	7	5.7	4.4	1.8	2.7
5			8.1	5.3	2.5	3.2
6			10.7	6.2	3.2	3.7
7			13.5	7.1	4.1	4.3
8					5.0	4.8
9					6.0	5.3

Support + Spacing

TUBE SIZE	HORIZONTAL SUPPORT SPACING	VERTICAL SUPPORT SPACING
1/2"	32"	Once Per Floor Penetration @ floor level (see pg 33-34). Once at midpoint of floor expanse or every 48"
3/4"	32"	
1"	32"	
1-1/4"	32"*	
1-1/2"	32"*	
2"	32"*	

*See individual mfg. instructions for continuous pipe support systems for large diameter horizontal arterial water mains.

Fitting Systems

ASTM F1807 Crimp, ASTM F2159 AccuCrimp, F1807 or F2159 w/ F877 V-Sleeve,
ASTM F2080 Lock, ASTM F1960 Grip

» Making the Connection & Common Connection Problems

This section explains the variety of fitting systems for PEX tubing that are defined by their respective ASTM Standards:

PEX Crimp includes – F1807 with Copper Crimp Ring, F2159 with Copper Crimp Ring, F1807/F2159 with V-Sleeve

PEX Expansion with Brass Sleeve – F2080

PEX Expansion with Plastic Sleeve – F1960



PowerPEX[®] ASTM F1807 CRIMP[™]

Standard Specification for Metal Insert Fittings Utilizing a Copper Crimp Ring for SDR-9 Cross-linked Polyethylene (PEX) Tubing.



PowerPEX[®] ASTM F2159 ACCUCRIMP[™]

Standard Specification for Plastic Insert Fittings Utilizing a Copper Crimp Ring for SDR-9 Cross-linked Polyethylene (PEX) Tubing.

PowerPEX[®] ASTM F2159
PowerPEX[®] ASTM F1807
WITH V-SLEEVE
CRIMP[™]

Proprietary specification for Sioux Chief V-Sleeve system utilizing ASTM F1807 metal or F2159 plastic insert fittings with Sioux Chief V-Sleeve.

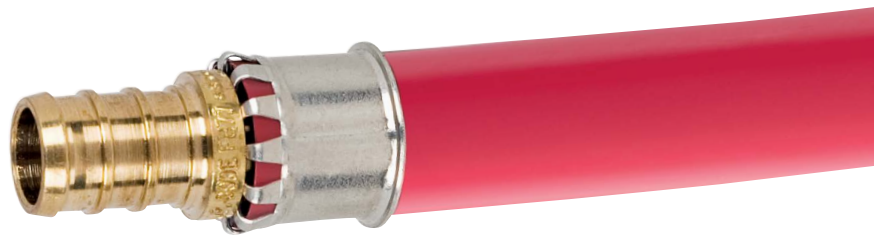

PowerPEX[®] ASTM F2080
LOCK[™]

Standard Specification for Cold Expansion Fittings with Metal Compression-Sleeves for Use with Cross-linked Polyethylene (PEX) Tubing.



PowerPEX[®] ASTM F1960
PEX-A
GRIP[™]

Standard Specification for Cold Expansion Fittings with PEX Reinforcing Rings for Use with Cross-linked Polyethylene (PEX) Tubing.



ASTM F1807 Crimp™

American Society for Testing and Materials (ASTM) Standard Specification for Metal Insert Fittings Utilizing a Copper Crimp Ring for SDR9 Cross-linked Polyethylene (PEX) Tubing and SDR9 Polyethylene of Raised Temperature (PE-RT) Tubing.

- F1807 fittings can be made from various listed materials. See ASTM standard for acceptable brass alloys. Assure your fitting is made from a listed material.
- F1807 systems use a copper crimp ring to compress around a fitting.
- Connection is made by positioning a crimp ring over a fitting's sealing barbs and compressing it into position.
- Fittings are reusable if barbs remain undamaged.

F1807 Installation



1. Cut tube at 90-degrees. Do not crush OD of tubing with cutters. Hint: Slightly rotate cutter during blade engagement.



2. Install PEX Crimp Ring onto OD of tubing.



3. Install PEX fitting into tube end.



4. Position ring over sealing barbs of the fitting. The ring should be positioned approximately 1/8" to 1/4" from the end of the tube.



5. Compress tool perpendicular to tubing run. Compress only once. Remove defective connections. Use a gauge to assure a proper joint. Test completed joint.

F1807 Application Problems

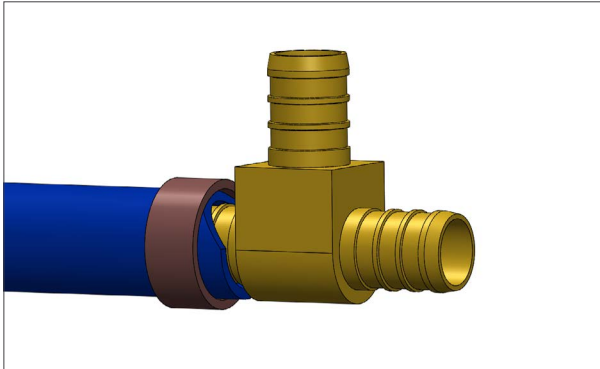

Tube not cut squarely – ring not compressing tube for a secure seal.

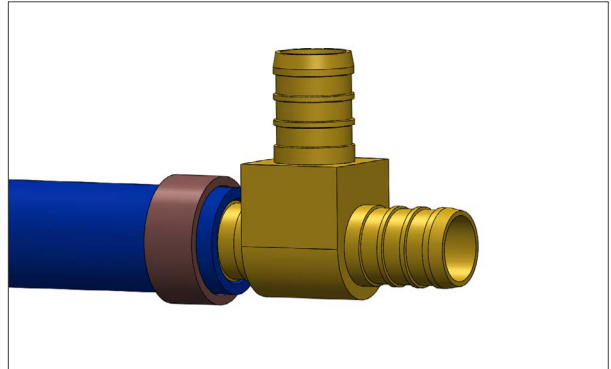

Fitting not inserted completely into tube end.

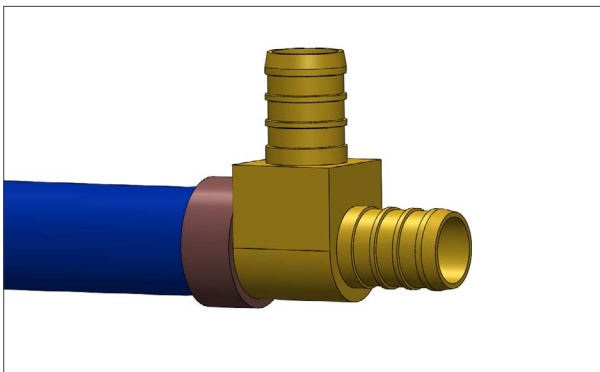

Ring not placed over sealing barbs of fitting. Ring too far forward or too far back & not fully over sealing barbs.

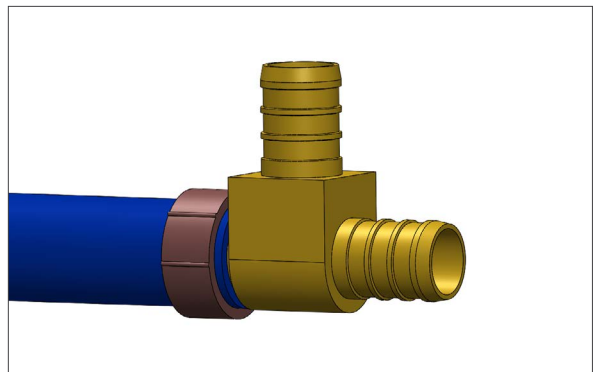

Crimp joint made with an improperly calibrated tool - not providing enough compression to joint.

Ring compressed multiple times possibly developing a leak path.

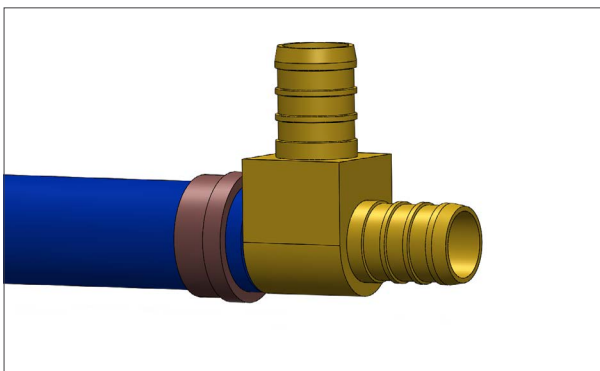

Crimp Tool did not engage the Crimp Ring over the entire surface of the ring.

ASTM F2159 AccuCrimp™

American Society for Testing and Materials Standard (ASTM) Specification for **Plastic Insert Fittings Utilizing a Copper Crimp Ring for SDR9 Cross-linked Polyethylene (PEX) Tubing and SDR9 Polyethylene of Raised Temperature (PE-RT) Tubing.**

- F2159 fittings are made from PPSU polymer. Sioux Chief uses Accudel resin.
- F2159 systems use a copper crimp ring to compress around a fitting.
- Connection is made by positioning a crimp ring over the tube and down to the tabs of the AccuCrimp fitting thereby positioning the ring perfectly over the sealing barbs. Compress assembly with a properly calibrated crimping tool.

F2159 Installation



1. Cut tube at 90-degrees. Do not crush OD of tubing with cutters. Hint: Slightly rotate cutter during blade engagement.



2. Install PEX Crimp Ring onto OD of tubing.



3. Install AccuCrimp fitting fully into tube end until ring engages the fitting tabs.



Note: Tabs will perfectly align the ring over the fitting's sealing barbs.



4. Compress tool perpendicular to tubing run. Compress only once. Remove defective connections. Use a gauge to assure a proper joint. Test completed joint.

F2159 Application Problems

See limitations illustrated in F1807 regarding calibrated tool, square-cut tube, fully inserted fittings and properly positioned ring.



Do not subject PPSU/PSU material to an open flame or solder within 18" of plastic product.



Good Fitting



Bad Fitting

Sioux Chief PPSU has been made white in color so that any harmful chemical exposure or UV exposure can be witnessed and suspect fittings can be removed from use.



Purple primer can be seen to have negatively affected the fitting. Be sure excessive oil on any connection system component does not contact the PPSU material. Fittings that have become subject to solvents (PVC primers/glues included) are negatively chemically affected and **MUST** be removed from service.

Handling and Use !

Petroleum based products, solvents, PVC glues and primers, gels, lubricants, pipe dopes, ethylene glycol, thread oils and paste or other volatile compounds should not come in contact with PPSU fittings. Store fittings away from harmful chemicals and direct sunlight (UV exposure). The maximum short-term working temperature (30 days) of fittings: 210 °F (99 °C) @ 150 PSI. Constant Working Temperature: 140 °F (60 °C) @ 55 PSI. PPSU should not be used in any installation within mechanical systems that may have oil or solvent residue. Do not impact PPSU/PSU polymer fittings. Do not subject fittings to torque limits exceeding 100 lbs. of force. Fittings should be kept free of mechanical stress. Each joint should be properly supported.

AccuCrimp products are suitable for radiant heating and cooling under the following conditions:

- 1.** Use only propylene glycol (food grade) to maximum 60% by volume
- 2.** DO NOT USE ETHYLENE GLYCOL WITH ACCUCRIMP PRODUCT
- 3.** Maximum temp: 194°F (90°C) at 44 PSI
- 4.** Recommended Corrosion Inhibitors: Metal Guard™
 - H50 6% by volume
 - H60 4% by volume
 - H80 4% by volume

ASTM F1807 or F2159 with ASTM F877 V-Sleeve™

See F1807 for installation

See F2159 for installation.

F877: American Society for Testing and Materials (ASTM) Standard Specification for **Cross-linked Polyethylene (PEX) Hot- and Cold-Water Distribution Systems (PE-RT) Tubing.**

ASTM F877 Sioux Chief V-Sleeve Stainless Steel Press Sleeve for PowerPEX (SDR9) Tubing

- Sioux Chief has patented a stainless steel sleeve for F1807 and/or F2159 fittings.
- V-Sleeve is a compression sleeve that incorporates notches at the top to evidence proper placement of the tube against the tube stop on a fitting, ensuring a perfect installation.
- Connection is made by compressing the sleeve to create a full 360-degree seal over all the sealing barbs. Sleeves can be pre-loaded onto the tube or fitting before installation and can remain in place for ease of installation.

V-Sleeve Installation



1. Cut tube at 90-degrees. Do not crush OD of tubing with cutters. Hint: Slightly rotate cutter during blade engagement.



2. Install V-Sleeve Stainless Steel Compression Sleeve onto OD of tubing OR onto the fitting. Load notched side first onto fitting.



3. Install either an F1807 fitting or an F2159 fitting fully into tube. Witness a fully inserted tube through the slots of the V-Sleeve top.



4. Assure sleeve is fully installed onto square cut tube and assembly is installed fully over a fitting.



5. Compress tool perpendicular to tubing run. Compress only once. Remove defective connections. Use a gauge to assure a proper joint. Test completed joint.



Note: V-Sleeve tool teeth assure a 360° compression of stainless sleeve.

V-Sleeve Application Problems

See limitations illustrated in F1807 regarding calibrated tool, square-cut tube, fully inserted fittings and properly positioned ring.



Be sure to use a V-Sleeve specific tool to make a connection. Different colored handle legs help distinguish long handle V-Sleeve tools.



Creased or bent sleeves should be removed from use.

ASTM F2080 Lock™

American Society for Testing and Materials (ASTM) Standard Specification for **Cold-Expansion Fittings With Metal Reinforcing Rings for Use with Cross-linked Polyethylene (PEX) Tubing.**

- F2080 fittings can be made from various certified, listed and approved materials. See ASTM standard for acceptable brass alloys. Assure your fitting is made from a listed material.
- F2080 expansion sleeves are metal.
- Compression is made by placing an expansion sleeve onto tube, expanding PEX tube, inserting a full-flow fitting, and pulling the sleeve up over the fitting and tube to secure the connection.

F2080 Installation



1. Cut tube at 90-degrees. Do not crush OD of tubing with cutters. Hint: Slightly rotate cutter during blade engagement.

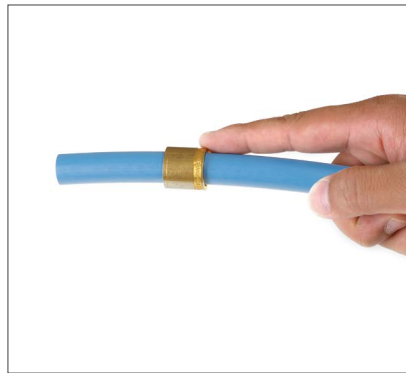

2. Slide F2080 sleeve at least 2" onto the PEX tube. It must be in the correct orientation. The sleeve end with the machined groove on the outer diameter should load onto tube first. The sleeve end with the tapered lip on the inner diameter should face toward the fitting.



3. Insert expander head of the F2080 tool into the PEX tube. Use a series of expansions and releases to slowly expand tubing. Rotate the expander head 45 degrees between expansions. PEX-B tube expansions MUST be made slowly.

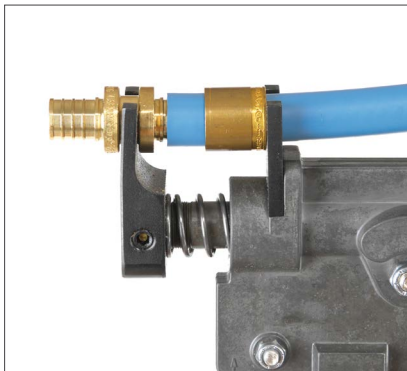

4. Insert fitting into the expanded tube until the fitting's last barb is 1/16" from the end of the tube. Mount the compression head forks of the F2080 tool onto the fitting yoke (space between the two radial flanges on fitting) and over the tube behind the sleeve.

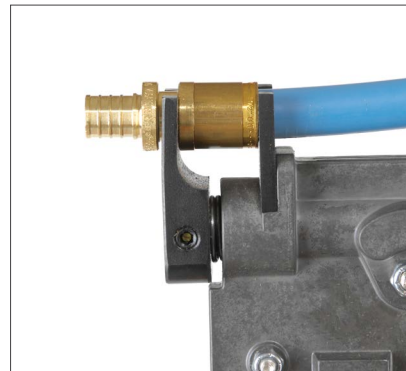

5. Compress the F2080 tool. The sleeve will begin to move toward the fitting. Continue compressing until the sleeve meets the surface of the outside fitting flange.

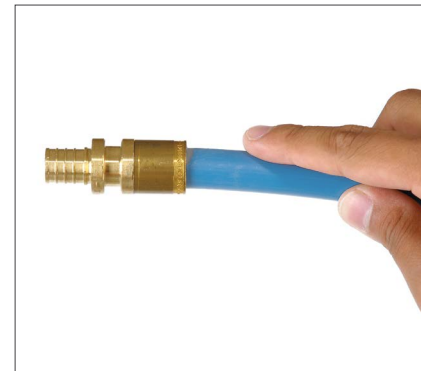

6. Inspect the secured joint. Assure there are no visible gaps between the sleeve and the fitting flange. Remove defective connections. Test completed joint.

F2080 Application Problems

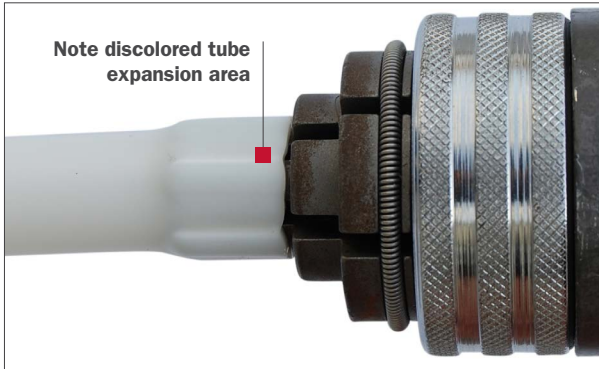

Expand Type-B tube slowly and assure expansion jaw is rotated in tube between expansions. Assure that the expansion is uniform without thin sections. NOTE: Cold tube needs to be addressed with a greater amount of caution than 55°F or warmer tubing.



Do not install brass sleeve backwards. The sleeve has been tested as installed backwards and does provide a solid connection; however, the sleeve is built with an ID tooth to keep a tube from backing off. To assure the most robust connection, install the sleeve correctly.



Do not expand tube too close to another fitting where the expansion jaw may overlap into the existing sleeve because the tool jaws will break on the ID of the brass sleeve.

ASTM F1960 Grip™

American Society for Testing and Materials (ASTM) Standard Specification for Cold-Expansion Fittings With PEX Reinforcing Rings for Use with Cross-linked Polyethylene (PEX) Tubing.

- F1960 fittings can be made from various certified, listed and approved materials. See ASTM standard for acceptable brass alloys. Assure your fitting is made from a listed material.
- F1960 compression rings are PEX.
- Compression is made by placing a compression ring onto tube, expanding PEX tube and ring, inserting a full-flow fitting, and holding in place until tube / ring memory secures the connection.
- Handling requirements are included within the Fitting / Ring Limitation Section.
- Fittings are reusable if barb is undamaged.

F1960 Installation



1. Cut tube at 90-degrees. Do not crush OD of tubing with cutters. Hint: Slightly rotate cutter during blade engagement.



2. Install PEX sleeve onto OD of tubing.



3. Using tube expander, expand sleeve fully. Repeat expansions, rotating expander 1/8-turn between expansions. Note: To limit the amount of time for tube compression onto fitting in cold environments, expand the tube/sleeve slowly and only enough to fully insert the fitting. Keeping sleeves warm will speed retraction and inhibit unequal expansion.



4. Insert fitting into expanded tube and sleeve. Assure proper expansion so that fitting is touching tube and sleeve. Hold fitting in place until tube/sleeve memory constrict annularly around the fitting.



5. The installation is complete with a visibly secure connection. Remove defective connections. Test completed joint.

F1960 Application Problems



Tube not cut squarely – ring and tube need to be mated perfectly and installed fully over F1960 barb for a viable seal.



Fitting not inserted completely into expanded tube and ring.

Ring not fully covering PEX tubing.



Leak path. Expansion did not rotate between multiple expansions, leaving a groove or leak path past the fitting barb. Expansion made with a defective expansion head.

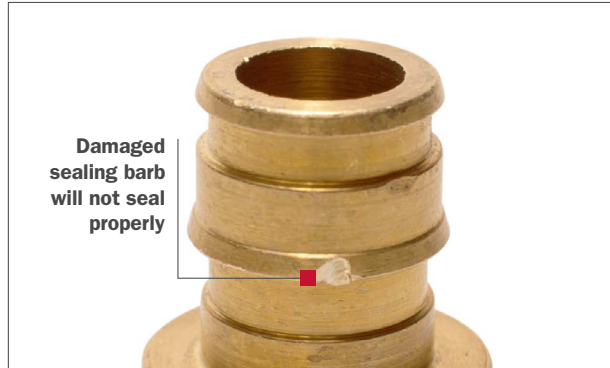

Damaged, cut or grooved sealing barb.

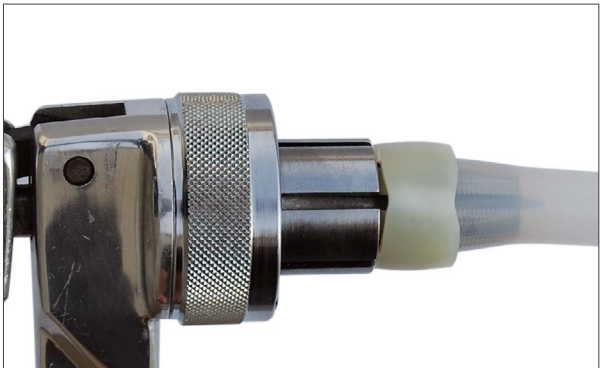

Ring must be kept around 55°F or greater to assure expansion is uniform. Remove any expanded ring that displays unequal expansion. Failure to rotate tool inside tubing may cause unequal expansion.



Sunlight: PPSU and Polymer fittings and plastic tube should be protected from UV exposure.



Glue/Primers/Chemicals: PPSU and Polymer fittings should be protected from harmful chemical exposure. See CAUTION for harmful chemical exposure in ASTM F2159 (pg 16 & pg. 40).



Flame: PPSU and Polymer fittings should not be soldered to or near (min. of 18" separation when soldering). Flame or heating sources beyond material tolerances must be avoided.

Tools & Accessories

» Use & Verification

This section describes various installation tools and accessories. Some of the more common tools and accessories for use with PEX tubing and the use thereof are included.

Tools for various PowerPEX ASTM system fittings are covered for use, tool verification and general tool upkeep.

PEX Accessories

PEX Tube Cutter

USE: Hold cutter perpendicular to tubing. When cutter is set at a right angle to tube length, squeeze handle and cut tube flush. Slightly rotate tube cutter when blade engages tubing OD to prevent "ovaling" the tube.

TOOL REPAIR: Remove screw and replace cutting blade with replacement blade. Reassemble and replace the screw.



Compression Insert

USE: Stainless Steel or PPSU PEX inserts (tube stiffeners) must be used when a supply fixture valve will be pushed on or compressed onto the OD of PEX.



Crimp Ring Removal

USE: Cut the tube close to the fitting. Place ring removal tool into the fitting end and make two cuts approximately 3/8" apart. Remove ring sections with pliers. Twist off tube. **Inspect** fitting for reuse. Assure sealing barbs are undamaged and fitting has not been compromised.



Adjustments to Crimp & Press Tools

USE: Tool adjustment methods differ for various models. Read instructions. Generally, remove C-Clip and rotate preload pin to a new position and re-install clip (see page 25).



Protection for Crimp & Press Tools

USE: Place Tool in protective case or secure box to assure the tool head remains free from abuse.



Copper Crimp Ring & V-Sleeve Stainless Steel Sleeve

Go/No Go Gauge

USE:

1. If 'Go' fits over connected ring/sleeve and 'No Go' does not, tool is properly making the connection.
2. If 'Go' does not fit over ring/sleeve, handle pre-load must be increased.
3. If 'No Go' fits over connected ring/sleeve, the joint is over-crimped. Remove joint. Decrease pre-load and check again.

- Do not file or adjust the 'Go' or 'No Go' gauge.
- The gauge must be perpendicular to the ring and tubing length being checked.

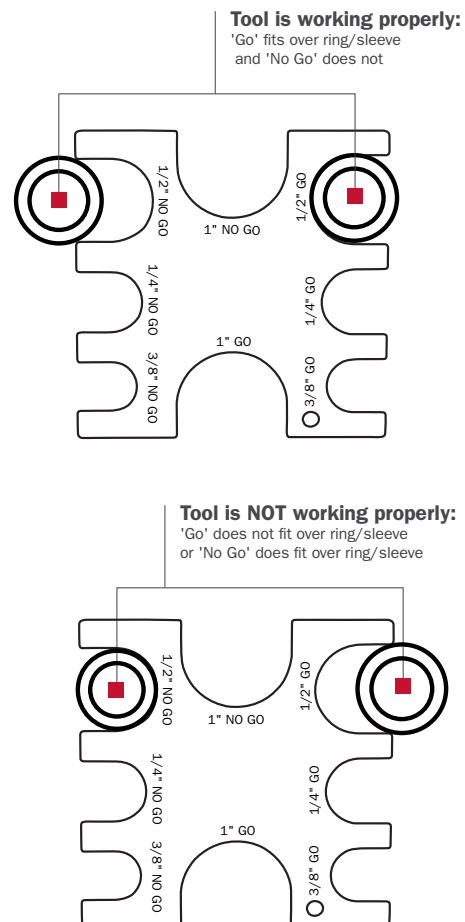

F1807/F2159 with V-Sleeve Tool Repair / Calibration

F1807 + Polybutylene Crimp Tools + F877 V-Sleeve Press Tools

Should the tools, through extended use, require adjustment, wear in the parts may be compensated for as follows:

1. Close tool handles until pre-load is reached (this is the point at which the jaws close but without fully compressing. Handle stops touch each other).
2. Measure the distance between the outside of the handles toward the end of the handle grips or the handle-end depression marks. Dim X is the correct distance (see tables).
3. To increase the pre-load setting, remove the eccentric lock/screw and rotate counter-clockwise to increase the handle pre-load and clockwise to decrease handle pre-load. Re-install the lock/screw in the appropriate hole which most closely yields the desired handle dimension.
4. Recheck the set distance after making three crimps.
5. Check the crimps with a crimp gauge. If satisfactory crimps do not result, the tool is likely worn and should be replaced.
6. Do not gauge where tool jaws meet.



CRIMP COMPOSITE HANDLE | 14" LENGTH

ITEM NO.	SIZE	PRE-LOAD DIMENSION X
305-20CPK	1/2"	7-3/4" +/- 1/4"
305-30CPK	3/4"	7-3/4" +/- 1/4"
305-23CPK	1/2" over 3/4"	8-1/2" +/- 1/4"
305-40CPK	1"	7-3/4" +/- 1/4"
305-41CKIT	3/8", 1/2", 3/4" or 1"	8-1/2" - 9"

NOTE: Composite handles have a mark on each handles end to take preload measurement between.

CRIMP COMPACT HANDLE | 12.75" LENGTH

ITEM NO.	SIZE	PRE-LOAD DIMENSION X
305-91PK	3/8"	3-1/4" - 3-5/8"*
305-92PK	1/2"	3-1/4" - 3-5/8"*
305-93PK	3/4"	3-1/4" - 3-5/8"*

*Handle measurement taken 1-3/4" from end

V-SLEEVE COMPOSITE HANDLE | 16" LENGTH*

ITEM NO.	SIZE	PRE-LOAD DIMENSION X
305-82TX	1/2"	9-3/4" +/- 1/4"
305-83TX	3/4"	10-1/4" +/- 1/4"
305-84TX	1"	12" +/- 1/4"

*1" tool: 19-1/4" length

V-SLEEVE COMPACT HANDLE | 12.75" LENGTH

ITEM NO.	SIZE	PRE-LOAD DIMENSION X
305-92TX	1/2"	4-1/4" - 4-5/8"*
305-93TX	3/4"	3-7/8" - 4-1/4"*

*Handle measurement taken 1-3/4" from end

Note A: Always remember to check tool calibration. It is recommended that at least the first and last crimp of the day/project is tested.

Note B: Never exceed the specified handle distance when adjusting your crimp tool. Premature wear will result.

Note C: Lubricate linkages on a regular basis to maximize tool life.

Note D: Do not remove Date Code sticker. Removal voids tool warranty.

ASTM F2080 Lock Tools

Expansion Tool Verification and Use

(3/8" - 1¼")

USE:

1. Attach appropriately sized expansion head to an ASTM F2080 Lock expansion tool.
2. Ensure assembly is wholly intact and the male threads of the tool or female threads of the jaw set are not compromised.
3. Ensure the retention spring on the OD of the tool jaw is in place and not compromised. If a jaw section is missing or damaged, replace the expansion jaw.
4. Keep the expansion jaw and the tool driver properly lubricated.
5. For any battery issues with F2080 power tools under warranty, call Sioux Chief customer service.

Compression Tool Verification and Use

(3/8" - 1¼")

USE:

1. Remove set pin from both top and bottom tool handle section.
2. Place the compression jaw-set pieces in each side and place the set pin back through the tool and jaw guide hole, locking the piece to the tool. Jaw pieces must be positioned where offset is facing to the outside.
3. Open handle grips wide enough to place around backside of sleeve and fitting yoke. Once initial compression has been made, mid handle pivot can be opened and the linkage will allow further compression especially in tighter locations.
4. Ensure tool chain is not compromised or inhibited by debris. Ensure expansion end fully engages I.D. of pipe for proper installation.
5. Keep all linkages well lubricated for maximum tool wear.

Large Diameter

Expansion/Compression Tool Use

(1½" - 2")

USE – HYDRAULIC METHOD:

1. Screw on the expansion jaw for the appropriate sized connection. Place sleeve over tubing and make pipe expansion. Install fitting into the expansion.
2. Place compression jaws onto tool head. Both jaws must match for size of connection being made. The larger jaw loads onto tool first with platform end first. The second jaw loads with the platform first as well.
3. Line up holes in the fitting chuck and place the pin to lock jaw heads to tool.

TO MAKE JOINT:

1. Depress the pressure relief valve on the tool pump. Jaws will separate.
2. Place jaws around fitting yoke and sleeve. Assure tool fully engages fitting and sleeve in the correct flanged location for each.
3. Activate the tool until compression is complete. Depress the pressure relief to open tool jaws.
4. Test joint.

Do not touch moving Parts.

Battery or Hydraulic Tool Repairs:

Call Sioux Chief Manufacturing



ASTM F1960 Grip Tools

Expansion Tool Verification and Use

($\frac{1}{2}$ " - 1")

USE:

1. Attach appropriately sized expansion head to an ASTM F1960 Grip expansion tool.
2. Ensure assembly is wholly intact and the male threads of the tool or female threads of the jaw set are not compromised.
3. Ensure the retention spring on the OD of the tool jaw is in place and not compromised. If a jaw section is missing or damaged, replace the expansion jaw.
4. Keep the expansion jaw and the tool driver properly lubricated.
5. Place tool jaw into tube end/ring assembly and compress handles to expand for fitting install.

Note: For any battery issues with F1960 power tools under warranty, call Sioux Chief customer service.



General Installation Guidelines

»» Layouts, Examples, Manifold Systems and Common Problems to Avoid

This section explains general installation guidelines. It features layouts, examples and manifold systems. This section will explain common problems to avoid, not specific to connection methods.

Hybrid Systems/Combination Install

Hybrid Systems

WHAT: Hybrid systems combine multiple plumbing connection types within one system. Example: A branch run may be plumbed in F1807 whereas an arterial water main may be plumbed in copper or CPVC.

HOW: PowerPEX offers quality tube and quality fittings. Each is independently warranted regardless of system installation as long as they are in a compliant tube + fitting mix. Note: F1960 fittings must use PEX-A tubing.

WHEN: Hybrid applications work perfectly (as depicted on pg 29) in applications where a header is plumbed in a more thermally stable tubing offering while branching off to a more flexible and cost-effective connection system solution.

WHY: A plumber or building owner should not be restricted from choosing the strongest connection system that an application may require, or a connection system they are not comfortable with, or that does not allow them to compete.

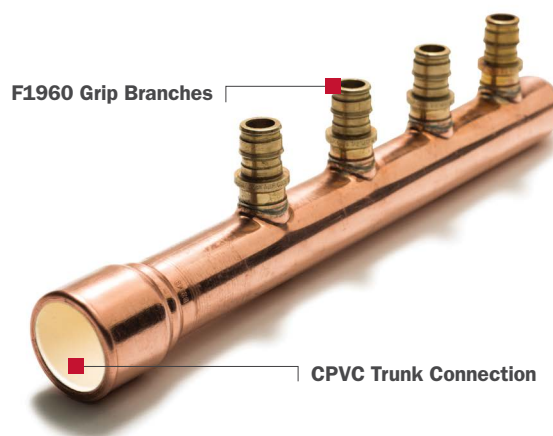

Hybrid Systems/Combination Install

Continued

Combination Systems. Combine the best features of a home run plumbing system with the best features of a trunk and branch plumbing system.

This smarter choice:

- Saves material expense, especially in No Lead compliant systems.
- Requires half the installation time of traditional systems.
- Requires fewer connections, which translates to fewer leak possibilities, fewer callbacks and fewer claims.
- Exhibits increased flow characteristics, decreased hot water wait times and a decrease in system noise.

Combination: 16 fittings
Trunk & Branch: 96 fittings

Combination: 59 connections
Trunk & Branch: 165 connections

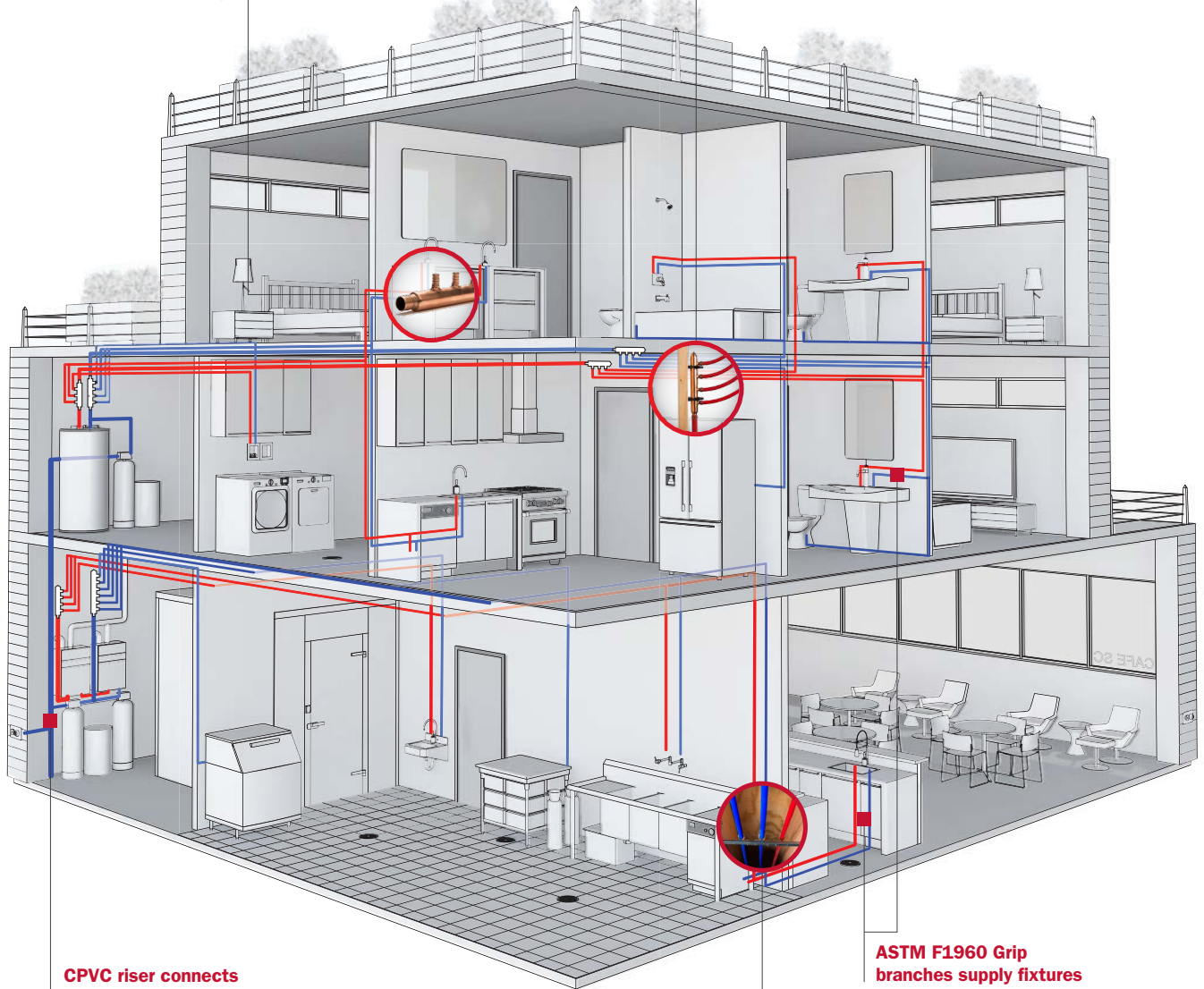

CPVC riser connects directly to manifold

ASTM F1960 Grip branches supply fixtures

Combination: 637ft of tube
Home Run: 1,515ft of tube

System Installation Options

Home Run

Fixture outlets are serviced from a central distribution point(s) similar to an electrical panel or breaker box. These manifolds are often referred to as primary manifolds and when used in this manner, can isolate a fixture for repair or service, and can assure proper flow characteristics at the fixture by providing an individual supply line. Primary manifolds for home run plumbing typically incorporate valves for proper line segregation and service.

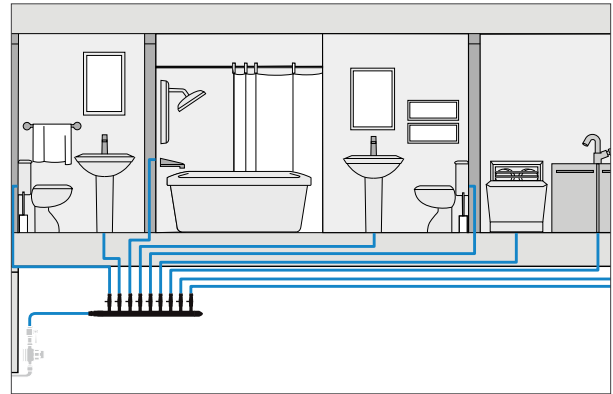

Standard / Trunk & Branch

A network of supply tube and fittings service fixtures and are put together like conventional copper or CPVC systems. For every change in direction within the system, an elbow or tee is used (directionals). There is typically more volume of water within a system of this nature and stagnant water must be purged before hot water is realized.

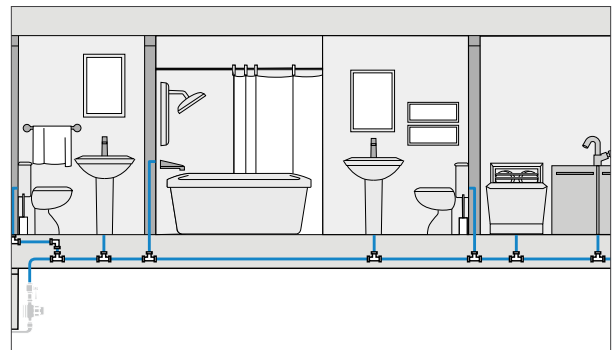

Combination

Fixture outlets are serviced from a manifold with a line being directly plumbed from a primary manifold or a secondary manifold. Secondary manifolds are either with valve or without valve and can be installed in-line. Manifolds with valves typically require access, so manifolds without valves are more often used as secondary manifolds and can be hidden in walls. Often, the manifold is marked with the fixture it supplies and a plumbing layout schematic marks the manifold location as well as the fixture it provides. **Sioux Chief recommends this plumbing system approach.**

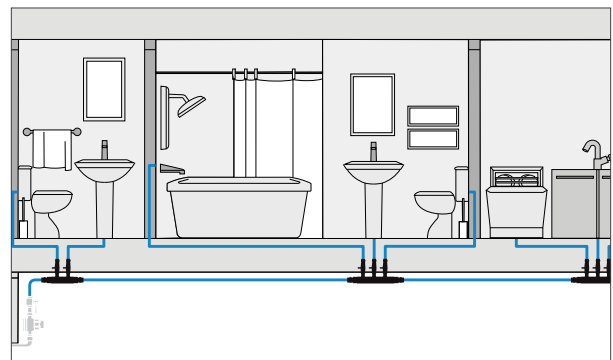

Branchmaster Manifold Plumbing

Sizing

Using manifolds can be accomplished with one of the previously mentioned plumbing layouts. Typically, the size of the manifold is dependent on the amount of fixtures it will be supplying. Sioux Chief offers manifolds with different trunk sizes and in varying outlet connections and sizes. All outside hydrants and/or auxiliary fixtures fed from their own supply line would total the branch quantity needed. Some manifold applications purposefully oversize the manifold by 2 branches for possible future additions. These 'extra branches' are typically sealed off with a plug. If two fixtures within a bathroom or kitchen application can legally be supplied with a single supply line, the manifold would reflect one less branch.

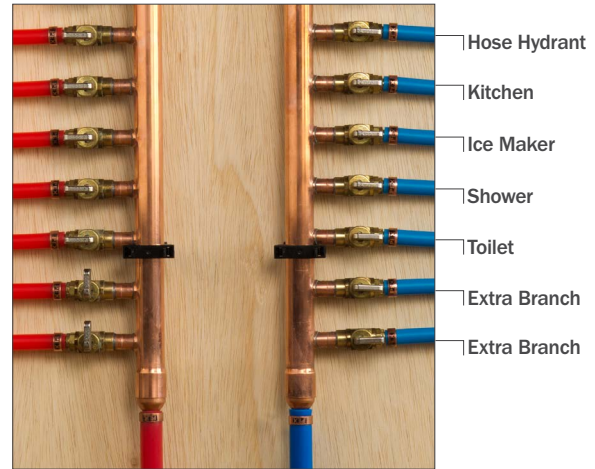

Location / Accessibility

Typical home run applications should dictate that a manifold is located near the water conditioning equipment, utility room, or water heater. This area is chosen so that the heated water is fed as quickly as possible to the distribution point for efficient transfer of conditioned water. In any case, the location chosen should be readily accessible for service situations. Manifolds should not be located closer than 3" from a water heater hot line outlet.



The home run layout has half of the connections at the manifold itself with the other half located at the stub out and/or supply stop.

Combination systems allow the cold water distribution manifold (no valve) to be located in a convenient area within the structure (no access panels are required for manifolds without valves).

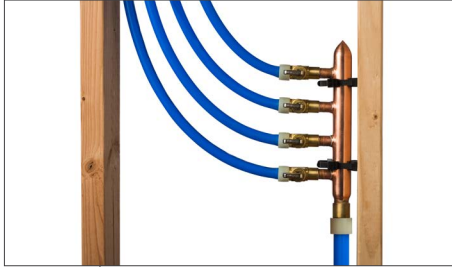

Manifolds with Valve
Often located in service rooms
or behind access panels

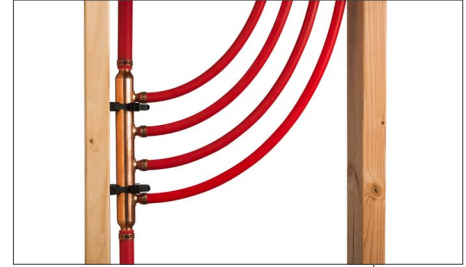

Manifolds, Flow-Through
Often in-line without valves

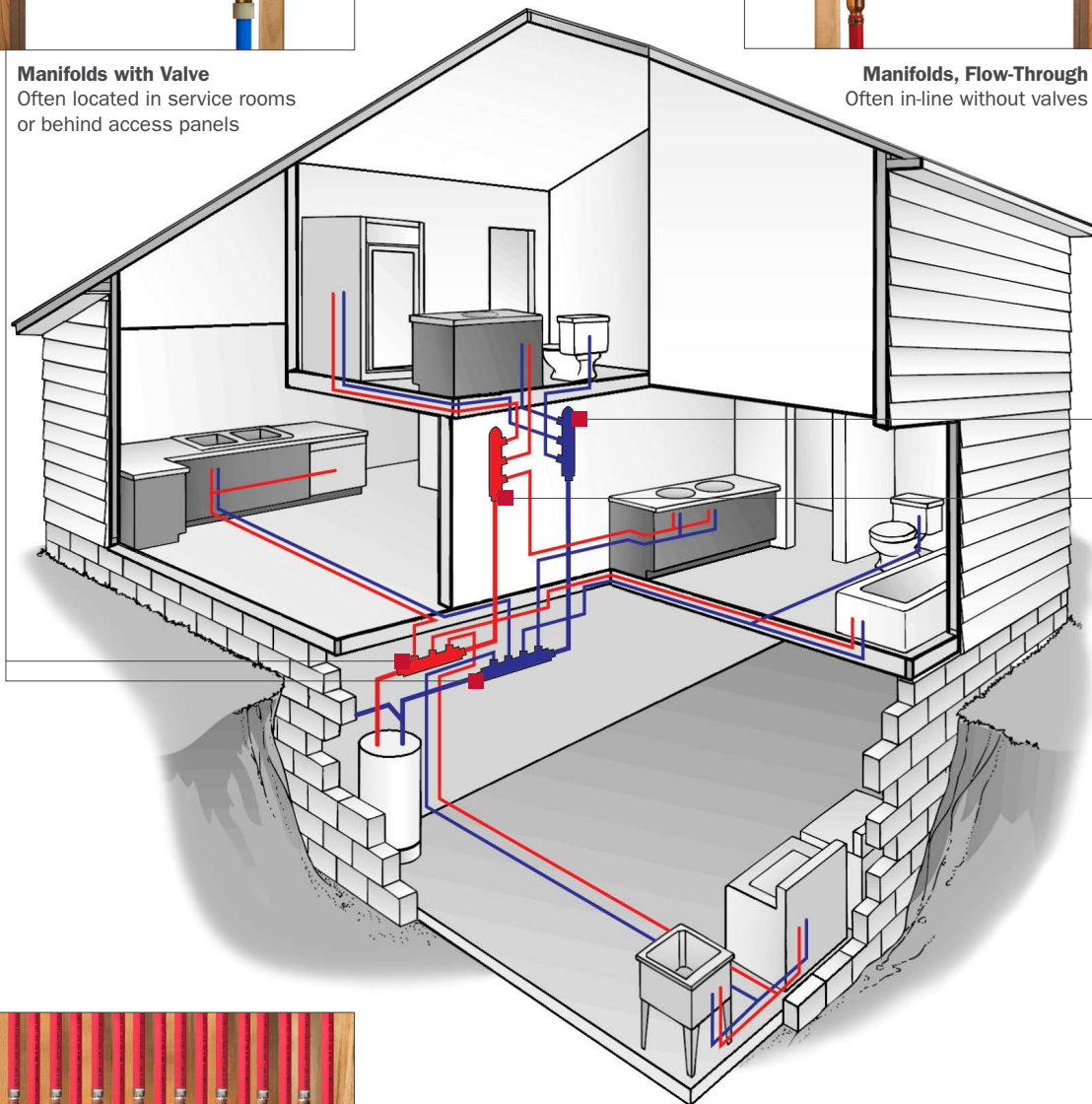

Radiant Manifolds
Allow for fine-tuning of supplied
water volume to radiators or tubing
loops (not shown in illustration)

Tubing Installation Requirements & Limitations

Tube Protection

- Protect tube with properly regulated and certified stud guards and metal plating where tube protrudes through building members. See tubing insulation requirements below.
- When undue stress will be placed on a connection joint, use an appropriate fitting with strapping means (drop ear elbow, eared stub out) and make connection to secured fitting.

Example: Shower arm installations. Hydrant installations

Tube Support

- Reference mandated support length intervals through local code regulations. Typically horizontal spacing shall be every 32" and vertical spacing shall be 48" and at each floor penetration.
- Tube supports should be used to support a long tubing length/run in addition to regular tube support intervals.
- Supports should be used to secure any expansion loop or tubing offset.
- PEX bend supports can be used to assure proper bend radius requirements are being met.

Tube Insulation

- Proper tube insulation shall be used when a tube protrudes through wood or metal studs. Insulating tube is typically a practice used to guard the tube from:

1. Potential harm as in the case of metal stud insulators.
2. Thermal dissipation protection. Do not bundle hot and cold tubes together.
3. Noise dampening. PEX has a higher modulus of elasticity whereby noise/acoustic transmission is less likely. Insulators further guard against this phenomenon.

Slab Installation

- Use a tube sleeve material when penetrating a slab or concrete floor.

Note: Sioux Chief recommends a rigid tube support/sleeve when entering and exiting a concrete installation for proper protection during construction and placement of tubing.

- Do not make any fitting connections under slab (Install PEX in a continuous length)

Inspection & Pressure Test

- Ensure all tube is free of defects and harm.
- Inspect all connections to assure they are leak-free and properly supported.
- Proper tube anchors and fasteners must be used.
- Test the system as code dictates. Where the code is absent, test to 100 psi for no less than 12 hours before covering any connection or tubing underground or behind walls.
- If testing with water, protect from freezing.
- If more than 10% pressure is lost during hydrostatic or air tests, add more and test for another 12 hours.

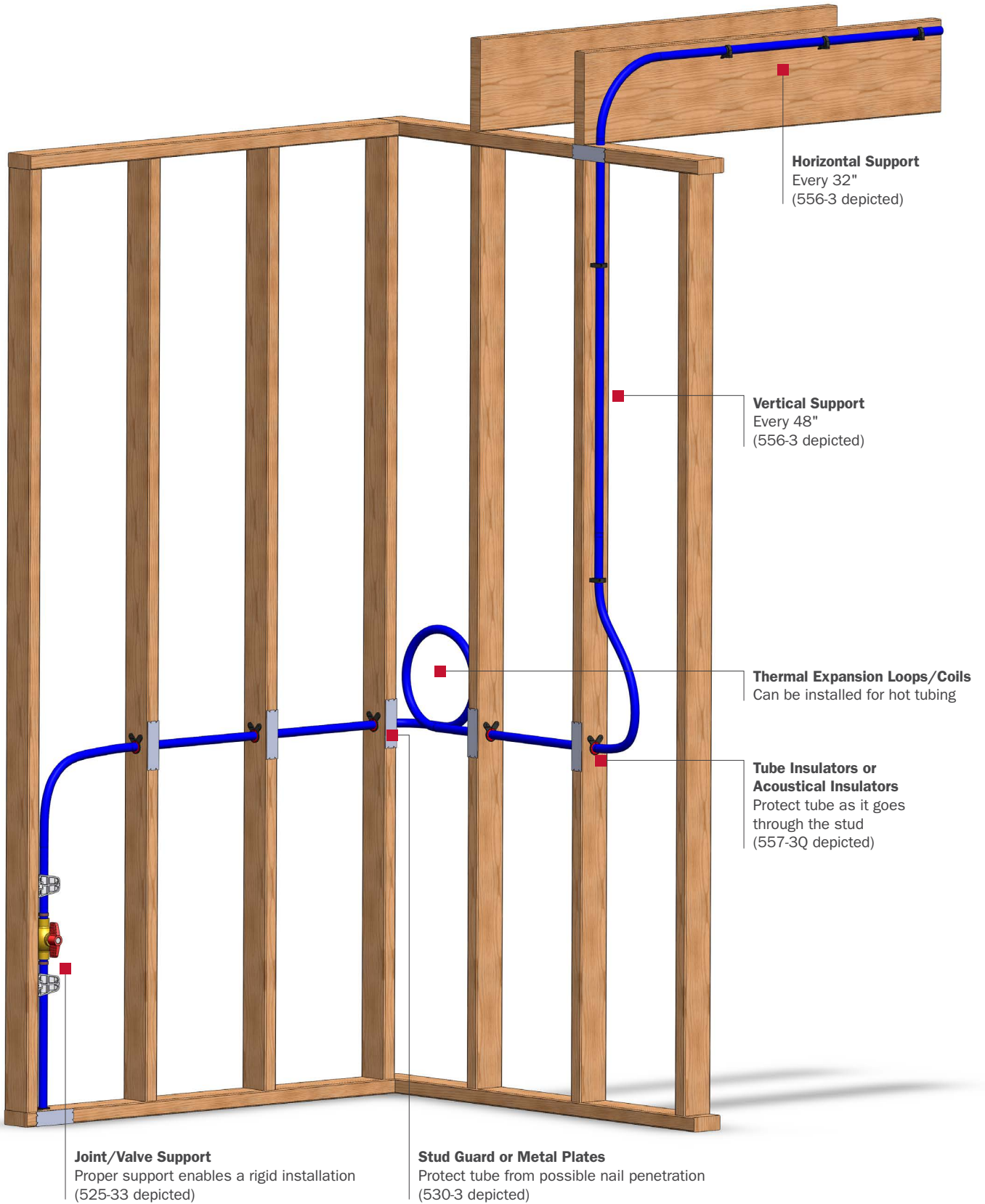

Tubing Installation Requirements & Limitations

Continued

Sleeving Service Main

- Where PowerPEX tubing enters foundation walls, rigid tubing shall be used to protect tube from shearing due to ground settlement or other earth movement. The rigid sleeve shall protrude into the earth minimally 12" and pass through to the interior of the building. Backer rod (closed-cell foam rod or mineral wool) can be used to seal the gap around the tube and capped with water based caulking as filler.
- Where PowerPEX tubing enters concrete floors, follow referenced slab penetration sleeve recommendations.

Expansion Joint Protection

(Concrete)

When PowerPEX tubing is being run below an eventual radiant-type expansion joint, tubing shall be protected from the possibility of being cut using a metal sleeve material and/or by assuring that the tubing is suitably set below the eventual cut.

Repairs in Service Work

If damage occurs to tubing while in the service stage, it is recommended that the area be replaced (if at all possible) without the use of a fitting below grade. When a fitting must be installed below grade, use a fitting made from C69300 brass for maximum dezincification resistance and stress corrosion cracking resistance. Sleeve and insulate the entire connection for protection from possible corrosion and from any mechanical stress that may occur. Test the assembly. Assure proper slack has been left in the line and proper backfill compaction has been obtained to limit movement on the connection.

Water System Disinfection

AWWA C651-86 shall be referenced when disinfecting PowerPEX tube installations and/or practices outlined by local codes.

- Do not allow solutions to remain in tubing for more than 24 hours
- Upon disinfection completion, flush all systems with potable water.
- Cover tube ends whenever not in use, preventing debris from entering tube.
- Only use disinfecting agents appropriate for PEX water service as well as possible use of PPSU PEX fittings.

Pressure Testing Water Mains

Water service tubing should have pressure applied throughout the installation. Air should be bled off the line prior to pressurizing fully hydrostatically. Sioux Chief recommends continuous pressure throughout the installation process to evidence any leaks or damage that may cause tube/connection failure. Testing water pressures should be set higher than the expected service pressure within the system. Do not test beyond 225 PSI for extended periods of time. 150 PSI water testing pressure is recommended for service mains throughout the construction phase.

Pressure Testing Water Tubing

Water: (recommended). When using water to test distribution tubing, it is important to follow local codes. It is important not to exceed the pressure limit of the tubing. Reference the continuous use pressures and hydrostatic pressure limitations in section 2.4.

Air: When using air to test pipe, there may be a need to condition the pipe especially when testing in hotter weather. B tubing does not need to be conditioned to the extent that A tubing should due to physical characteristics of the two tubing types. Conditioning the pipe is a process used to slightly expand the tubing ID beyond what the test will effectively expand it to in an effort to maintain the desired test pressure without a 'false negative' of decreased pressure due to normal tubing expansion. Expanding the tube by using 40 psi beyond the testing pressure would be recommended. Sioux Chief would suggest testing with air up to 80 psi.

Procedure:

- 1) Fill system with air or water.
- 2) Remove all plumbing fixtures or appurtenances that may harm a pressure test and/or should not be exposed to excessive pressures.
- 3) Increase pressure over desired testing pressure for a period of about 30 minutes while maintaining the higher PSI. IE: 100 psi if testing pressure will be 60.
- 4) After the 30-min conditioning time, relieve pressure down to 60. The PSI may climb slightly above 60 as the pipe shrinks due to relieved pressure. After witnessing the final pressure (which may take about 5 minutes depending on ambient temperature and may increase to around 63-65 PSI), determine if the system is air tight over the necessary code mandated testing time.

Tubing Installation Requirements & Limitations

Continued

Water Service Installation & Limitations

Getting Started. Local codes should be referenced for acceptable pressures as well as special precautions on use of PEX, system fittings, layout and installation requirements for service piping. Typical water service pressure requirements often mandate that the service is capable of withstanding 1.5x the operating pressure of the system it is supplying. See listed PEX pressure ratings. Ensure the fittings and tubing being installed are acceptable for potential pressures, stresses, and application requirements.

Preparation. Check all tubing and fittings for proper listings. Check all tubing and fittings for structural and manufacturing integrity as well as issues that may have arisen from transport or initial installation. Remove any fitting or tube section that has been subjected to cuts, gouges or other excessive installation hazards. Make sure proper analysis of soil and soil chemistry has been completed. Make sure trench is prepared according to guidelines.

Soil Analysis. Do not install PEX tube or fittings in areas where known chemical spills have occurred or where a likely chemical spill can occur. Do not install PowerPEX tubing in soils contaminated with solvents, fuels, organic solvents, pesticides or other harmful materials for plastic tubing or its fitting systems. Local plumbing code authorities and Sioux Chief should be contacted if there is a question on the installation or area of installation.

Note 1: Do not allow backfill weight to cause tube to become out-of-round beyond 5%. Do not over compact backfill.

Note 2: Sioux Chief recommends using a sleeve material for the entire length of the buried service main.

Trench Layout Guidelines. If the soil has been graded and deemed acceptable, the next step is to gauge the type of soil so that proper installation can proceed. Installations shall be made in an acceptable soil condition or prepared soil condition that supports the tube against future settlement. ASTM D2774 and AWWA report TR31 shall be additionally referenced for plastic tube used for service work.

Installation In Different Soil Types

Good Soils. Tube may be directly installed on the trench bottom. Code should be referenced for embedment practices and necessary spacing requirements of the tube in the ground. Tube should be laid into trench with slack. Trench bottom is to be clear of any pits or humps as well as sharp objects. Test tube. Compact initial backfill to prevent settlement. Test after backfill.

Rocky Soils + Solid Rock. Tube shall have an additional 6" of trench dug below desired level of service tubing. Prepared trench bottom shall have a 6" layer of pea gravel or other non-sharp substrate trench base installed (pea gravel suggested). Prevent humps or pits where tubing will be laid. Test tube. Compact initial backfill to prevent settlement. Backfill with 6" of the substrate used for the base. Test after backfill.

Unstable Soils. Tube shall have an additional 4" of trench dug below the desired level of the service tubing. Prepared trench bottom shall have a 4" layer of pea gravel or other non-sharp substrate trench base installed (pea gravel suggested). Prevent humps or pits where tubing will be laid. Test tube. Compact initial backfill to prevent settlement. Backfill with 6" of the substrate used for the base.

Tubing Installation Requirements & Limitations

Continued

External Temperature

Soldering. Soldering shall be performed minimally 18" from installed PowerPEX tubing unless a heat-trapping device is employed. Make all sweat connections and allow cooling prior to making PEX connections to PowerPEX tubing.

Duct Work - Heating. Tubing shall be insulated from direct contact with heat transmission ductwork that has a possibility to exceed the maximum tubing working temperature of **180°F**. Tubing shall be kept 6" from gas appliance vents except those vents with a thermal protection approved for installation near plastic (PEX) tubing as explicitly called out by the manufacturer. In horizontal tube installations, keep tube 6" away from heat source.

Water Heater Connections. Connections to tubing shall be made minimally 18" from the water heater hot and cold connections on gas water heaters. Connections to tubing shall be made with metal transition fittings. See Sioux Chief Water Heater Connections section (www.siouxchief.com)

Heat Lamp + Lighting. Tubing shall be kept minimally 12" from heat source and proper protection shall be used to avoid overheating tubing. Keep tube protected and 12" from recessed lighting when installed in vertical alignment to heat source. If 12" distance is not available, proper insulation should be used to protect tubing where insulation maintains the necessary heating certifications for the application. PEX must be protected from any UV light-producing device.

Frozen Tubing. PEX tubing should not intentionally be frozen. The frozen section of tubing and the general area should be protected from further exposure to unadvisable installations. Heat the affected area or the blockage assuring that tubing does not overheat. Use a hand to test surface. Space heaters, warm towels, or warm water submersion are acceptable means to thaw tube.

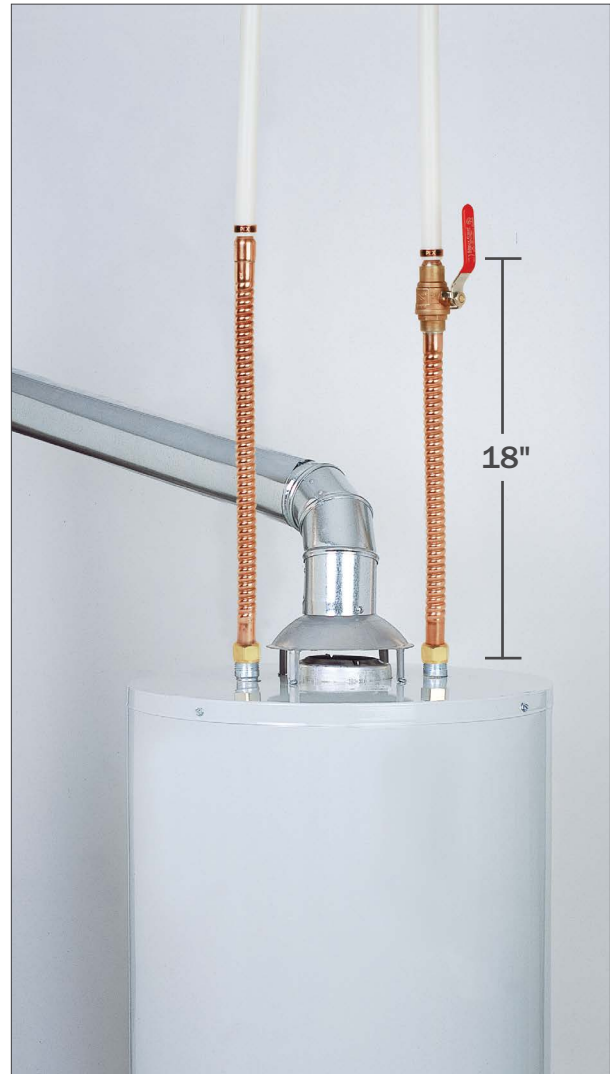

Welding. Do not attempt to weld or fuse tubing.

Kinked Tube. Remove Kinked sections or sections of pipe that have exceeded maximum out-of-roundness.

Tubing Installation Requirements & Limitations

Continued

Vermin Protection

Protect tube from exposure to rodents or other nuisances that may damage the tubing.

Water Hammer Exposure

Water Hammer is generally defined as the damaging pressure surge and banging noise caused by the quick stoppage of the water column when a valve or faucet is turned off abruptly. PEX tubing, like all other materials, needs to be protected from water hammer by the installation of certified water hammer arresters. If left uncontrolled, the water hammer pressure surge can exceed the pressure ratings for the tube, causing damage to the system and/or system components. Both the UPC and IPC model codes require the installation of ASSE 1010 water hammer arresters, regardless of tubing material. (See Sioux Chief's website for a full line of water hammer arresters for any application.)

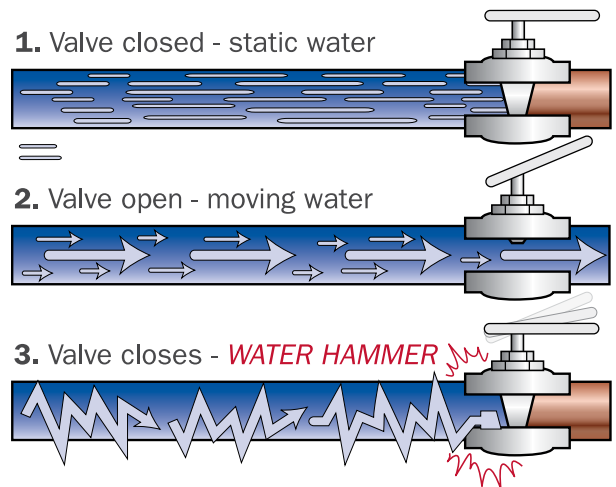

Bend Radius

TUBE	STANDARD BEND RADIUS	BETTER BEND RADIUS	AGAINST COIL SET BEND RADIUS
1/2"	3.75"	5"	11.25"
3/4"	5.25"	7"	15.75"



If coiled tubing is being used and the bend direction is against the coil direction, multiply noted bend radius by a factor of 3. Warmer tubing bends more easily. Generally a bend radius of 8x tube diameter should be sufficient. Using a manufactured PEX bend support will aid in assuring the proper bend radius.

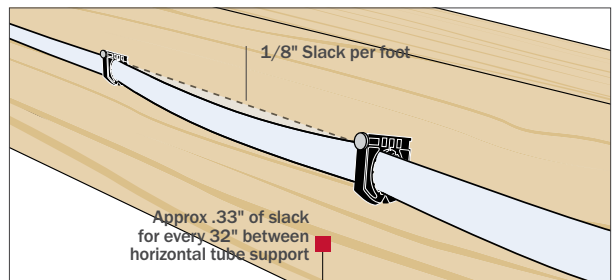

Thermal Expansion

- Linear expansion of PowerPEX tubing is approximately 1 inch per 100 feet of tubing for every 10°F change in temperature.
- Do not install tube supports or hangers too tightly. Allow for expansion of tube when bracketing and supporting PEX by allowing 1/8" slack for every 1 foot of linear installation.
- For large tubing runs, a tube loop can be installed to allow for proper expansion and contraction.

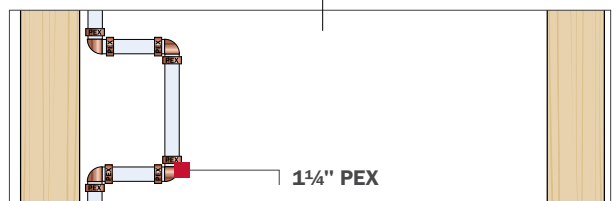

Avoiding Common Problems



Mechanical

- PowerPEX tubing should not be scratched, gouged or cut along tube length. Handle with care.
- Metal tubing hangers with sharp edges and corners should be avoided. Metal, vinyl-coated tubing hangers specifically designed for uses with PEX tube are acceptable. A better option would be to use an approved plastic hanger from Sioux Chief's extensive line of CTS hanging options.

Note: Acceptable Metal hangers may include PEX bend supports and straight-thru floor sleeves. Plastic PEX bend supports should be used when size and offering permit.

- Tubing hangers that can easily pinch the tube should not be used. Limit the 'ovaling' of the tube a hanger may cause. Tubing shall not be crushed or bent beyond the materials min. bend radius and/or beyond 5% out-of round by tubing hangers.



Chemical

PowerPEX tubing is a durable, safe and chemically resistant material that has exceeded the requirements of potable drinking water systems with the highest chlorine testing certifications possible. Tubing that exhibits damage caused by contact with the following should not be used: grease, tar, adhesive tapes, thinners, fuels, sealants, tube cements, fluxes, bleaches, other oxidizing agents and/or petroleum products.

- Do not allow adhesives to continuously contact tubing. Remove any residue left by temporary or unintentional exposure to product tube and fittings.
- Do not use solvent-based paints or petroleum products on or in PowerPEX tubing.
- Only use water-soluble fire caulking for fire suppression systems and penetration methods.
- Do not allow contact with acids or strong bases.
- Keep pesticides and other organic chemicals free of tube.
- Do not glue or attempt to fuse to PowerPEX tubing.

Electrical

Tube and tube/fitting system shall not be used as an electric ground.

Gas Use

Only use PowerPEX tube in a manner consistent with the tubing identification marking and certifications. Only use PowerPEX in applications presented within this manual and accepted through local and jurisdictional codes. Contact Sioux Chief with questions.



Ultraviolet (UV) Exposure

Do not store PEX tubing unprotected outdoors. Keep PEX tubing in the original packaging or under protective cover until time of installation. Ensure that exposure to sunlight during installation does not exceed the maximum recommended UV exposure time for the tube being installed. See Section 2.2 for a tube's identification marking.

Leak Testing Solutions

All leak-testing agents must be approved for PEX tubing. Some chemicals found in leak-detecting formulations can cause premature PEX tubing failure by developing micro-fracturing of the tube wall.

Avoiding Common Problems

Continued

PPSU (polyphenylsulfone) or Polymer Fitting Limitations

PPSU/Polymer fittings shall not be used in applications where temperature and pressure ratings are not regulated or are known to evidence exposures beyond those listed within this manual. See F2159 & F1960 installation instructions and application problems.

Sioux Chief PPSU fittings use engineered resin to achieve substantial strength and chemical resistance. PPSU, must be installed carefully and should adhere to the guidelines laid out in application installation and problem sections for each ASTM system standard and reiterated below:

- Fittings shall be stored away from and not installed with exposure to direct sunlight, open flame/heat source or volatile compounds (including PVC glues, primers or other solvents).
- Do not impact PPSU/Poly fittings or subject fittings to torque limits exceeding 100 lbs of force.
- Do not use PPSU fittings in radiant systems with glycol that has not expressly been listed nor in concentrations above established limits.

Brass Fitting Limitations

Sioux Chief's PEX fittings, valves and connectors/adapters are made from multiple materials. These fittings should be installed where allowed by code for hot/cold plumbing applications. For aggressive water jurisdictions prone to dezincification or for areas requiring no-lead fittings, Sioux Chief carries a line of dezincification resistant brass and copper fittings. Fittings should not be buried directly in soils.

Do not allow PEX fitting barbs and fitting ends to be deformed or damaged. A fitting that exhibits a damaged sealing barb or sealing surface should be removed from service.

Copper Fitting Limitations

Sioux Chief's capability as a world leading engineered copper-fitting provider allows Sioux Chief the option of offering naturally no-lead and dezincification resistant copper fittings for PEX F1807 applications.

These fittings are:

- Economical
- Accepted
- Listed
- Historically proven
- Robust metal

Do not bury copper fittings or connections directly in soil. Proper wraps must be used when fittings are buried in soil. Do not install copper fittings in areas prone to copper deterioration.

Do not allow PEX fitting barbs and fitting ends to be deformed or damaged. A fitting that exhibits a damaged sealing barb or sealing surface should be removed from service.

Stainless Steel Fitting Limitations

Sioux Chief sells some PEX fittings in stainless alloys or as an assembly with stainless alloys. Assure these fittings are used as potable water fittings for the referenced applications within this manual. Stainless steel products should generally be protected from caustic environments that are known to degrade stainless materials including, but not limited to, high chlorine or bromine environments and/or other environments that produce halogens.



ASTM F878 + F877 PowerPEX or SDR9 Tubing

- PowerPEX is 3rd party listed and approved and has undergone extensive testing to assure the process, facility, ongoing testing and procedure exceed industry standards for PEX tube extrusion.
- ASTM tube standards call out the wall thickness, I.D., O.D., % cross-linking, out-of-round, etc. Sioux Chief PowerPEX continuously monitors and checks all of these parameters to assure 100% compliant tube.
- Connection is made through various separate ASTM fitting standards for use with the appropriate SDR of the manufactured tube. Sioux Chief manufactures tube as SDR-9.
- Handling requirements are included within the PowerPEX tube limitation section.

Certifications & Listings

»» We Are Trusted, Tested and Listed

Sioux Chief PowerPEX tubing and various PEX fitting systems have been certified and listed to the below. The following third party testing and listing agencies assure product is made to national standards and adhere to certain requirements set forth by those standards.

The installation instructions (section 3) should be referenced for each system type. Sioux Chief offers PowerPEX tubing and various PEX fitting systems that conform to one or more of the following referenced PEX Standards:

CSA B137.5

CSA B137 SERIES-13

Thermoplastic pressure piping compendium

ANSI / NSF 14

Plastics Piping System Components and Related Materials

ANSI / NSF 61

Drinking Water System Components - Health Effects.

NSF / PPI

PEX 5306 (exceeds oxidative stability requirements for hot water re-circulating systems (CL-5) per ASTM F876) (meets requirements of ASTM F876 for outdoor exposure of up to 6 months while maintaining CL-5 oxidative stability)

IAPMO (UPC)

Sioux Chief File Number: 8214

Cross-linked Polyethylene (PEX)

ASTM F876

American Society for Testing and Materials Standard Specification for Cross-linked Polyethylene (PEX)

ASTM F877

American Society for Testing and Materials Standard Specification for Cross-linked Polyethylene (PEX) HOT- and Cold- Water Distribution Systems

ASTM F2023

American Society for Testing and Materials Standard Test Method for Evaluating the Oxidative Resistance of Cross-linked Polyethylene (PEX) Tubing and Systems to Hot Chlorinated Water

ASTM C904

American Water Works Association Standard for Cross-linked Polyethylene (PEX) Pressure Tubes, ½ In. (12mm) Through 3 In. (76 mm) for Water Service C904

Note: Individual fitting standards (ASTM F1807, F2159, F2080, F1960) are used in conjunction with PowerPEX tubing (either Type-A or Type-B) and should be referenced for specifics on fitting dimensions and materials per each standard.



Sioux Chief is an American Manufacturing Company. Product design through production and shipping happens from its Missouri headquarters. SCM chooses to build product in the USA with US materials and an American workforce.

Warranty & Terms of Use

»» World Class Warranty + Trusted Customer Service

Warranties are important. That is why Sioux Chief has always had one of the best warranties in the industry. Sioux Chief does not limit the builder, contractor or homeowner's right to a sound warranty.

LIMITED LIFETIME WARRANTY

Sioux Chief Mfg. Co., Inc. ("Seller" or "the Seller") warrants its products to be free from defects in material and workmanship under normal usage for the lifetime of the plumbing system in which they were originally incorporated. In the event of such defects within the warranty period, the Company will, at its option, replace or recondition the product without charge. This remedy shall be effective only if the product was installed in accordance with supplied instructions, common installation or use practices and existing building and plumbing codes and legal requirements; has not been subjected to misuse or abuse; was at all times used in a manner consistent with its intended use; was at all times used in installations and environments acceptable to its material and design specifications; was never modified, altered or repaired by anyone other than the Seller; was properly subjected to and passed common testing methods (including pressure testing for potable water and drainage systems) immediately after the product's installation and before the product is put into service; was not damaged by freezing, corrosion, degradation or other adverse water, atmospheric or other natural conditions; was never subjected to improper protection during the installation or exposure to water pressures or temperatures outside acceptable operating conditions. In addition, Seller shall not be responsible for any incidental, special or consequential damages, including without limitation, lost profits or the cost of repairing or replacing other property which is damaged, other costs resulting from labor charges, delays, vandalism, negligence, fouling caused by foreign material, chemical or any other circumstances over which the Seller has no control. This warranty excludes all costs arising from routine maintenance, including the replacement of any parts required by such maintenance and the replacement of parts required by normal wear and tear. The Seller also reserves the right to modify, alter or improve its product, or parts thereof, at any

time without incurring an obligation to notify or modify, alter, improve or replace any product, or parts thereof, previously sold. If, on any occasion, Seller waives any term or condition, this waiver is not to be construed as a continuing waiver. For the purposes of this warranty, the lifetime of the original plumbing system is defined as the lesser of 25 years or the time before the plumbing system was replaced or materially changed; all products with automatically or manually moving parts are excluded from the limited lifetime warranty and carry a 3-year limited warranty, subject to the remaining terms, conditions and limitations of the warranty. Some States do not allow or have other parameters governing limitations on how long an implied warranty lasts, and some States do not allow the exclusion or limitation of incidental or consequential damages. This Limited Warranty gives you specific legal rights, and you may have other rights that vary from State to State. You should consult applicable state laws to determine your rights.

THE WARRANTY SET FORTH HEREIN ABOVE AND BELOW IS GIVEN EXPRESSLY AND IS THE ONLY WARRANTY GIVEN BY THE COMPANY WITH RESPECT TO THE PRODUCT. THE COMPANY MAKES NO OTHER WARRANTIES, EXPRESS OR IMPLIED. THE COMPANY HEREBY SPECIFICALLY DISCLAIMS ALL OTHER WARRANTIES, EXPRESS OR IMPLIED, INCLUDING BUT NOT LIMITED TO THE IMPLIED WARRANTIES OF MERCHANTABILITY AND FITNESS FOR A PARTICULAR PURPOSE.

The most up-to-date warranty is located at www.siouxchief.com.

TERMS + CONDITIONS

Visit Sioux Chief's website for information on warranty service, Returned Goods Procedure, freight considerations, minimum orders and pricing.

TAKE THE FIELD.

www.siouxchief.com

14940 Thunderbird Road
Kansas City, MO 64147
P 1.800.821.3944
F 1.800.758.5950



TAKE THE FIELD.

24110 South Peculiar Drive
Peculiar, Missouri 64078
P 1.800.821.3944
F 1.800.758.5950
DISTRIBUTED BY

www.siouxchief.com

