

SAMUEL HEATH

Product Number: T10KA15CBR

Description: 3 Hole lavatory filler, 8 5/16" spout height

Standards



Flow rates

Gallons/Min	1.5 PSI	7.3 PSI	14.5 PSI	29.0 PSI	43.5 PSI	58.0 PSI	72.5 PSI
		0.4	0.7	1.0	1.1	1.1	1.1

Flow rate data provided is indicative of each product and is given in open outlet conditions. Installation design, external connections and fittings not supplied may affect the data provided.



Finishes Available



Chrome Plate



Polished Nickel



Stainless Steel with Matt Black



City Bronze



Matt Black Chrome



Brushed Gold Matt



Polished nickel with gloss black chrome



Brushed Gold matt with City Bronze



Stainless steel finish with City Bronze



Antique Gold with gloss black chrome

Control Options Available



Specification Drawing

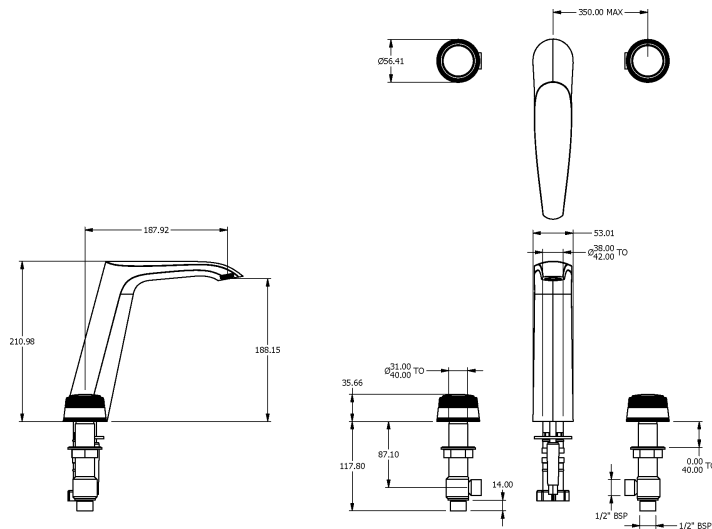

UK Customer Service

Leopold Street
Birmingham
B12 0UJ
Tel: +44 121 766 4200
Email: info@samuel-heath.com

US Customer Service

Federal I.D. No. 58-1504682
Email: usa@samuel-heath.com

Specification Enquiries

Design Centre Chelsea Harbour
1st Floor, North Dome, London
SW10 0XE
Tel: 020 7352 0249
Email: showroom@samuel-heath.com