



Middleton®

Top-mount Kitchen Sink
F14708-3

Features

- Top-mount
- Three faucet holes
- 8"-deep double bowls
- 3-5/8" drain opening
- Stainless steel with durable satin finish
- SilentShield technology
- 20-gauge stainless steel
- Lifetime limited warranty

Recommended Products/Accessories

11861 Sink Rack
7400 Sink Strainer
K-6139 Sponge Caddy

Included Components

Product consists of:
1150001 Installation Clips



Codes/Standards

ASME A112.19.3/CSA B45.4

STERLING® Warranty - Stainless Steel Sinks

See website for detailed warranty information.

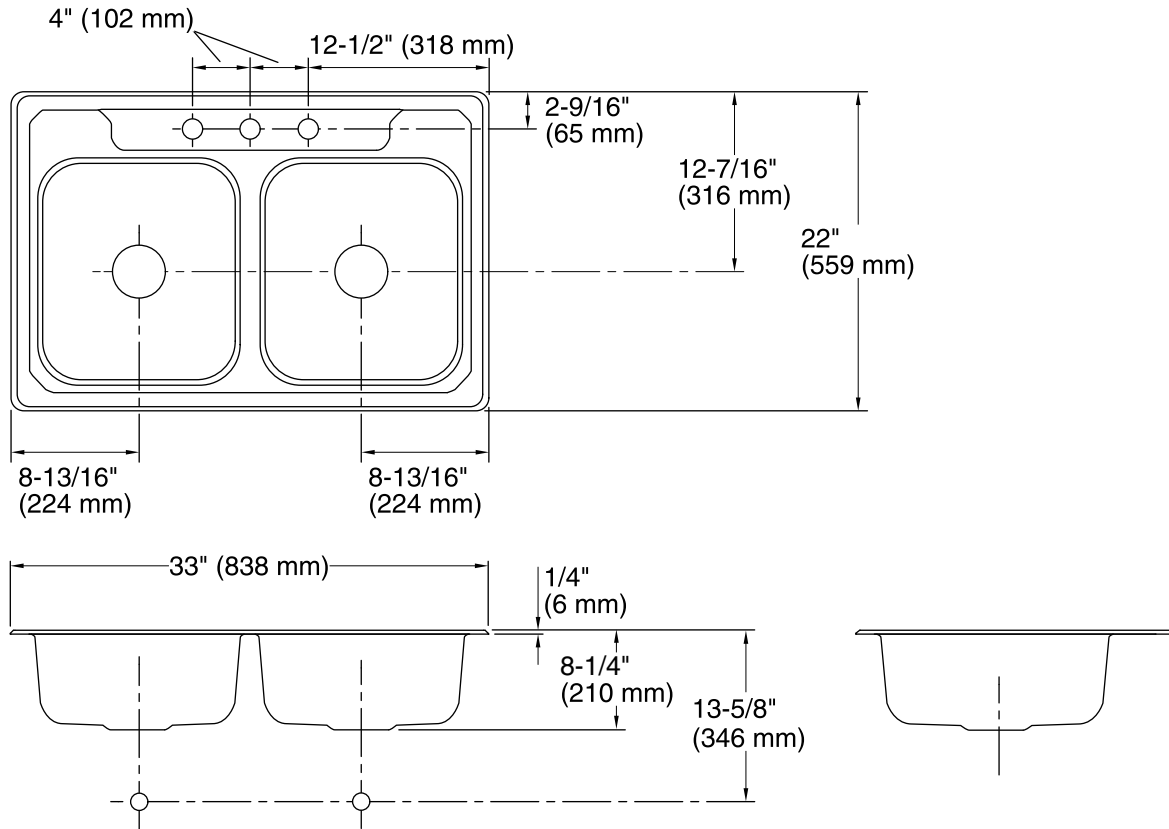

Technical Information

All product dimensions are nominal.

Bowl configuration:	Double equal
Installation:	Top-mount
Cutout:	Top-mount, 32-1/2" x 21-1/2" (826 mm x 546 mm) with 1/2" (13 mm) radius corners
Min. base cabinet width:	36" (914 mm)
Bowl area (Left):	Length: 14" (356 mm) Width: 15-1/8" (384 mm) Bowl depth: 8" (203 mm) Water depth: 8" (203 mm)
Bowl area (Right):	Length: 14" (356 mm) Width: 15-1/8" (384 mm) Bowl depth: 8" (203 mm) Water depth: 8" (203 mm)
Number of deck holes:	3
Faucet hole(s):	1-7/16" (37 mm)
Drain hole:	3-5/8" (92 mm)

Notes

Install this product according to the installation instructions.

Measure your actual product for roughing-in details.