



Standard Framed Sliding Shower Door 660B-59

Features

- Framed
- 1/8" glass
- Towel bar
- Out-of-plumb adjustability
- Tempered glass ensures maximum safety and durability
- Anodized aluminum prevents rusting and corrosion

Installation

- Not for use in hospitality.
- For residential use only.

Included Components

Additional Components:
Hardware kit



Codes/Standards

ANSI Z97.1
CPSC 16CFR 1201

STERLING® Warranty - Bath and Shower Doors

See website for detailed warranty information.

Available Colors/Finishes

Color tiles intended for reference only.

Color	Code	Description
-------	------	-------------

	S	
--	---	--

Available Glass Options

Code	Description
------	-------------

	Hammered
--	----------

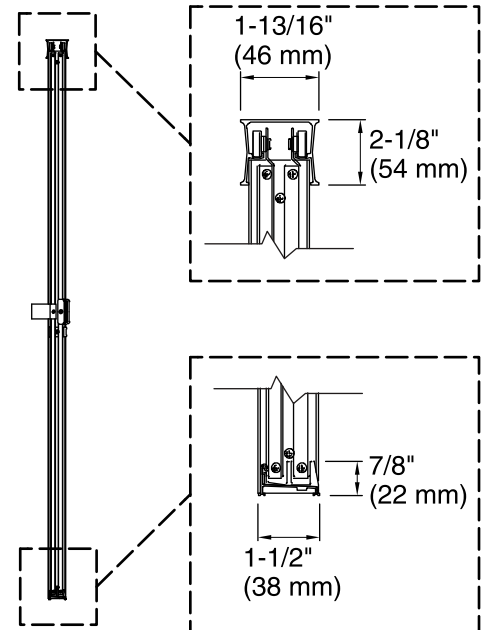
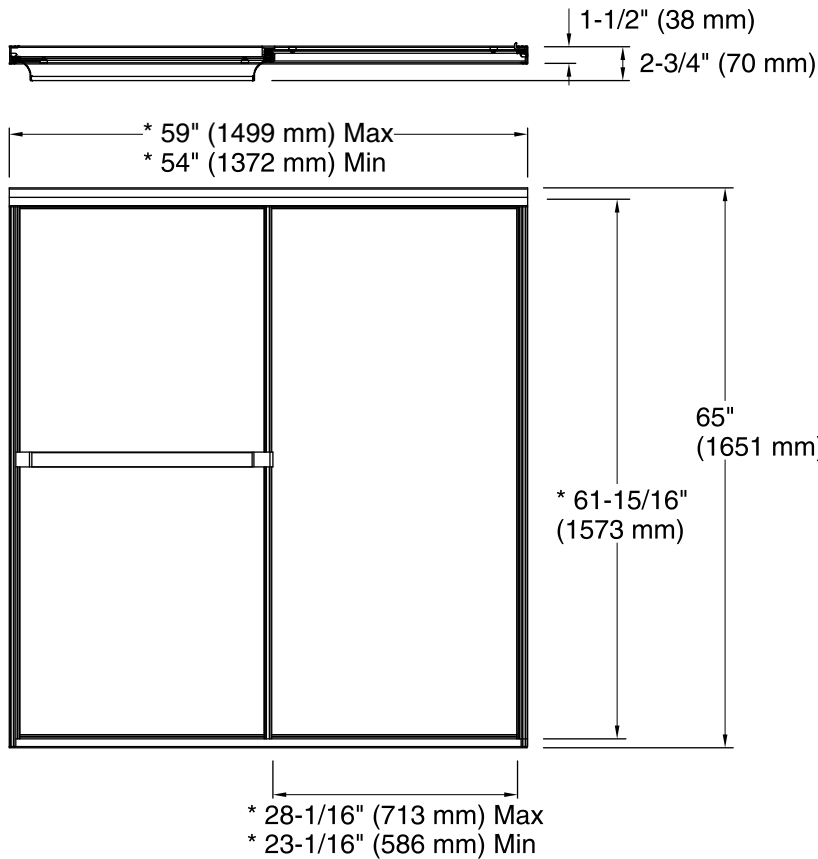

* Walk-through

Technical Information

All product dimensions are nominal.
 Installation type: For shower base installation
 Opening Width - Min: 54" (1372 mm)
 Opening Width - Max: 59" (1499 mm)
 Walk-through - Min: 23-1/16" (586 mm)
 Walk-through - Max: 28-1/16" (713 mm)
 Glass thickness: 1/8" (3 mm)

Notes

Install this product according to the installation guide.
 The vertical opening should be a minimum of 66-1/2" (1689 mm) to allow for installation clearance.