

CODE 100 (40") BASE UNIT / ARMAZÓN 100

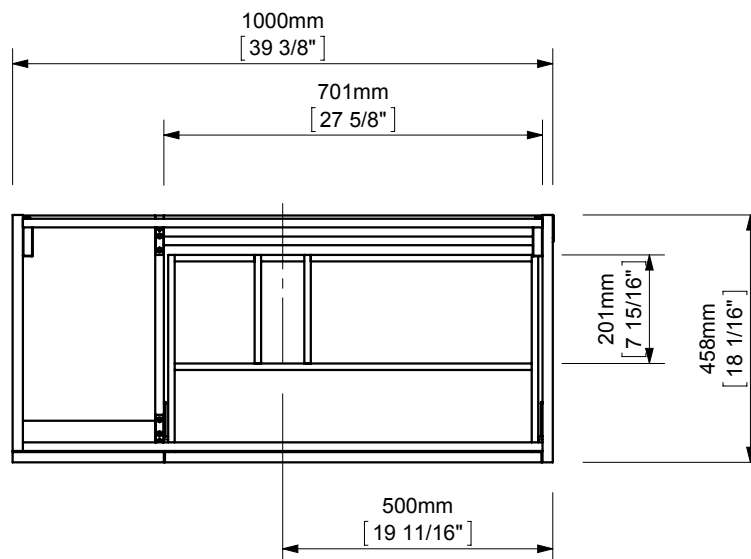
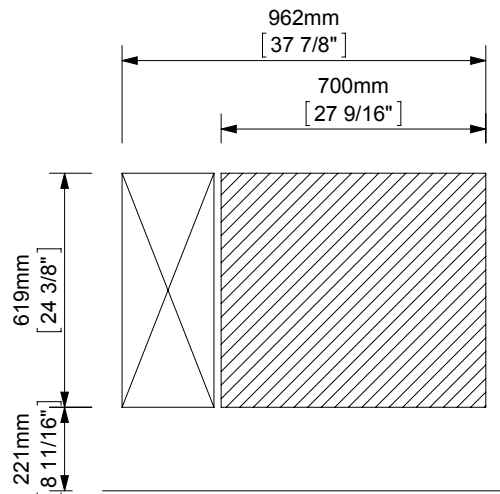
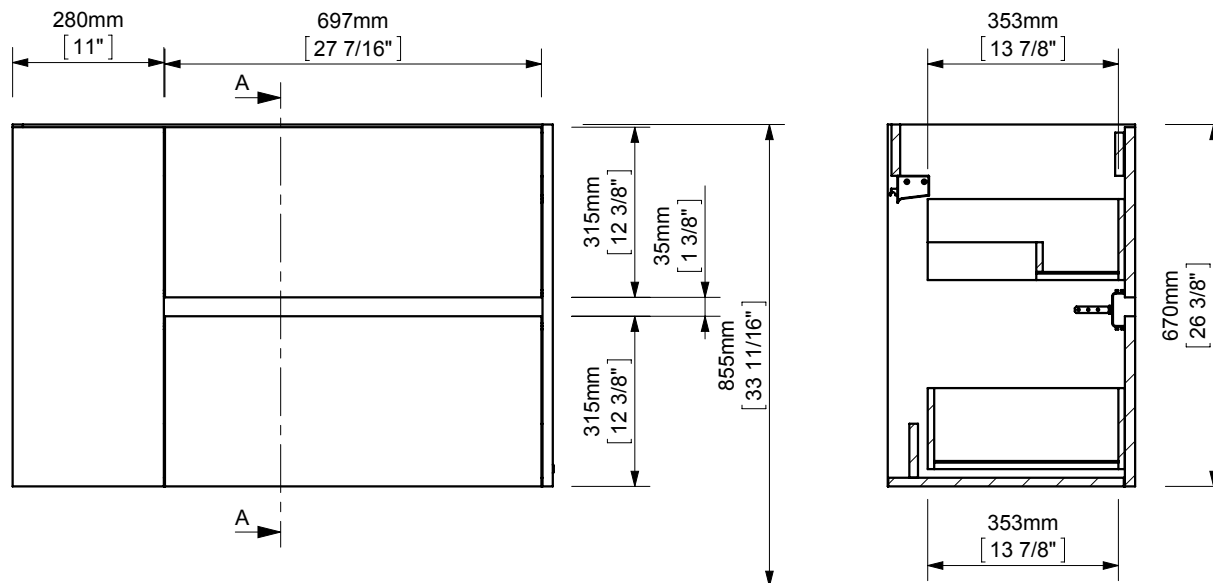
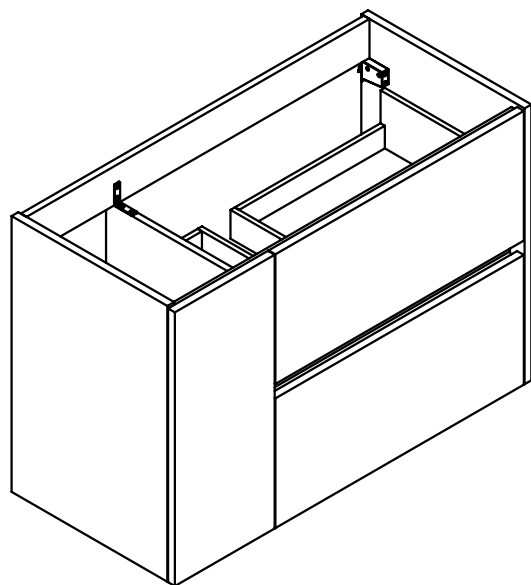

Area de instalación valvulas y desagües
 Installation area for water connections
 Zone d'installation des bondes et siphons
 Einbau Bereich für Ablaufgarnitur und Siphon

espec_567

Peso / Weight / Poids: 38Kg

Acabados / Finish / Finitions: Según tarifa vigente / As per valid pricelist / Selon le tarif en vigueur

Normas / Regulations / Normes: UNE 56867, UNE 56868, UNE EN14749

Imágenes no a escala / Draw not to scale / Echelle non respectée

Sonia S.A se reserva el derecho de realizar cualquier cambio sin previo aviso
 Sonia S.A has the right to make changes without notice
 Sonia S.A se réserve le droit de procéder à tout changement sans notification préalable



www.sonia-sa.com