

PRODUCT SPECIFICATION SHEET

ITEM # 708535

Cylindrical shower head with arm and round flange

- 3 functions: soft, normal, and massage sprays
- 1/2" NPT male connection
- 2.5 GPM
- Includes flow restrictor (CA 2.0 GPM CALGreen compliant)

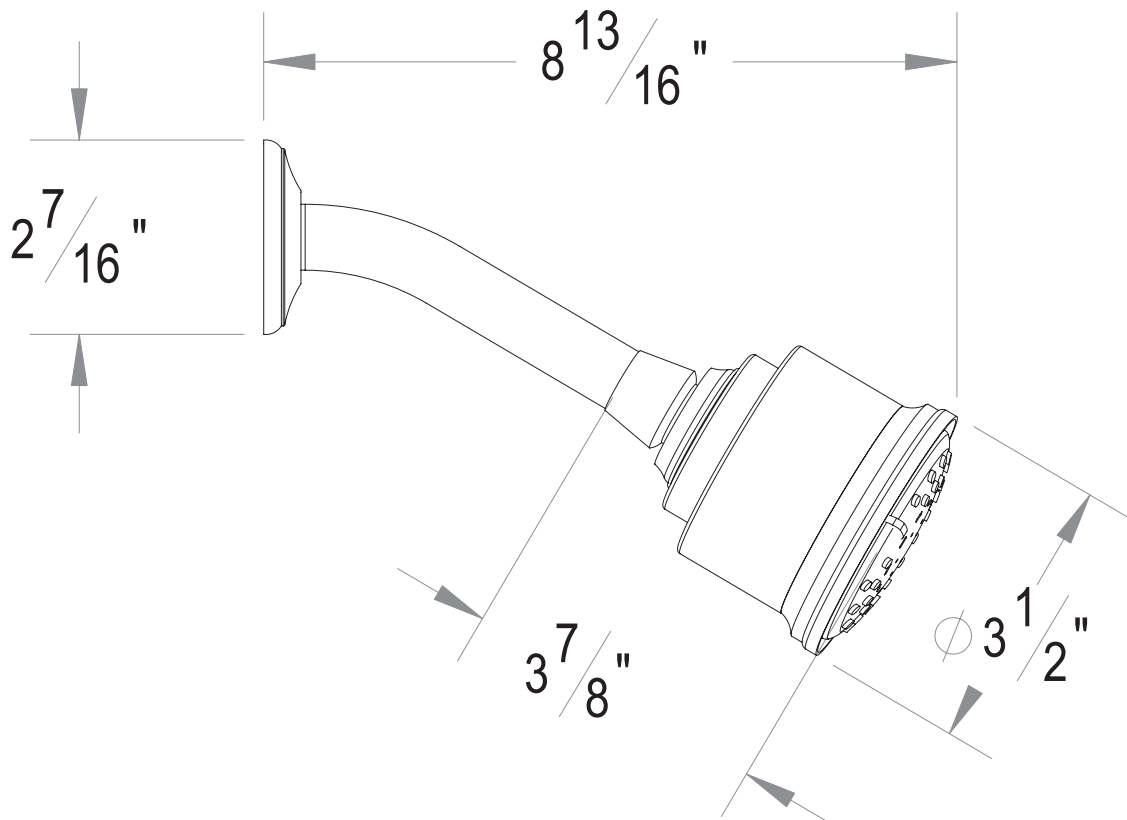

The measurements shown are for reference only. Products and specifications shown are subject to change without notice.