

Please read the instructions completely before beginning the installation.



INSTALLATION INSTRUCTIONS

Supply elbow included

-Supply elbow requires a 1/2" Male Nipple 2 1/2" beyond finished wall.

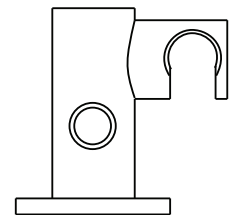

Assembly

1- Put mounting toggle in the wall.

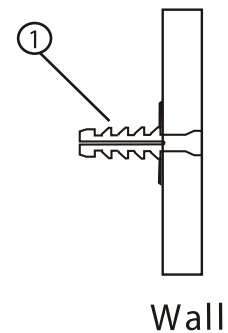

2- Put in the screw through the bracket base into the plastic toggle already mounted in the wall.

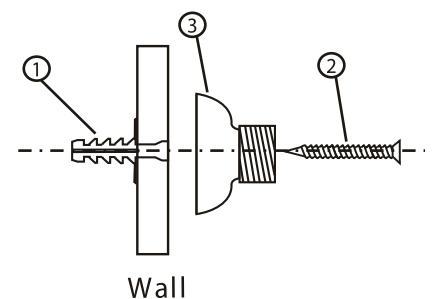

3- Put the spring and the concave disk first in the bracket open end.

The measurements shown are for reference only. Products and specifications shown are subject to change without notice.

www.santecfaucet.com | P: 310.542.0063 F: 310.542.5681

4- Put the bracket ball end in to the hole. It will be seated on the concave disk.

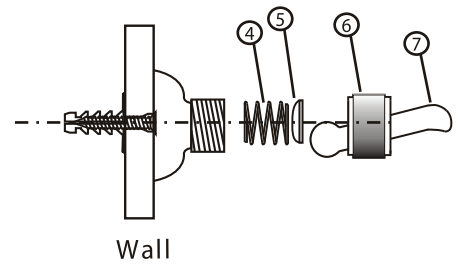

5- Thread on bracket nut on the bracket base.

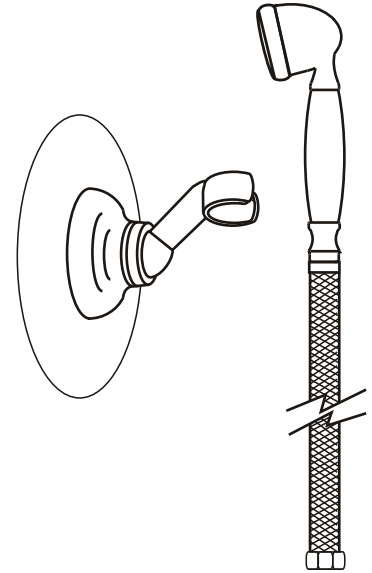

6- Assembled bracket on the wall will be as shown in the figure.

7- Hand held shower will be on the bracket as shown in the below given figure.

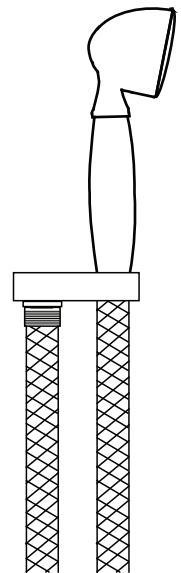

PARTS DRAWING

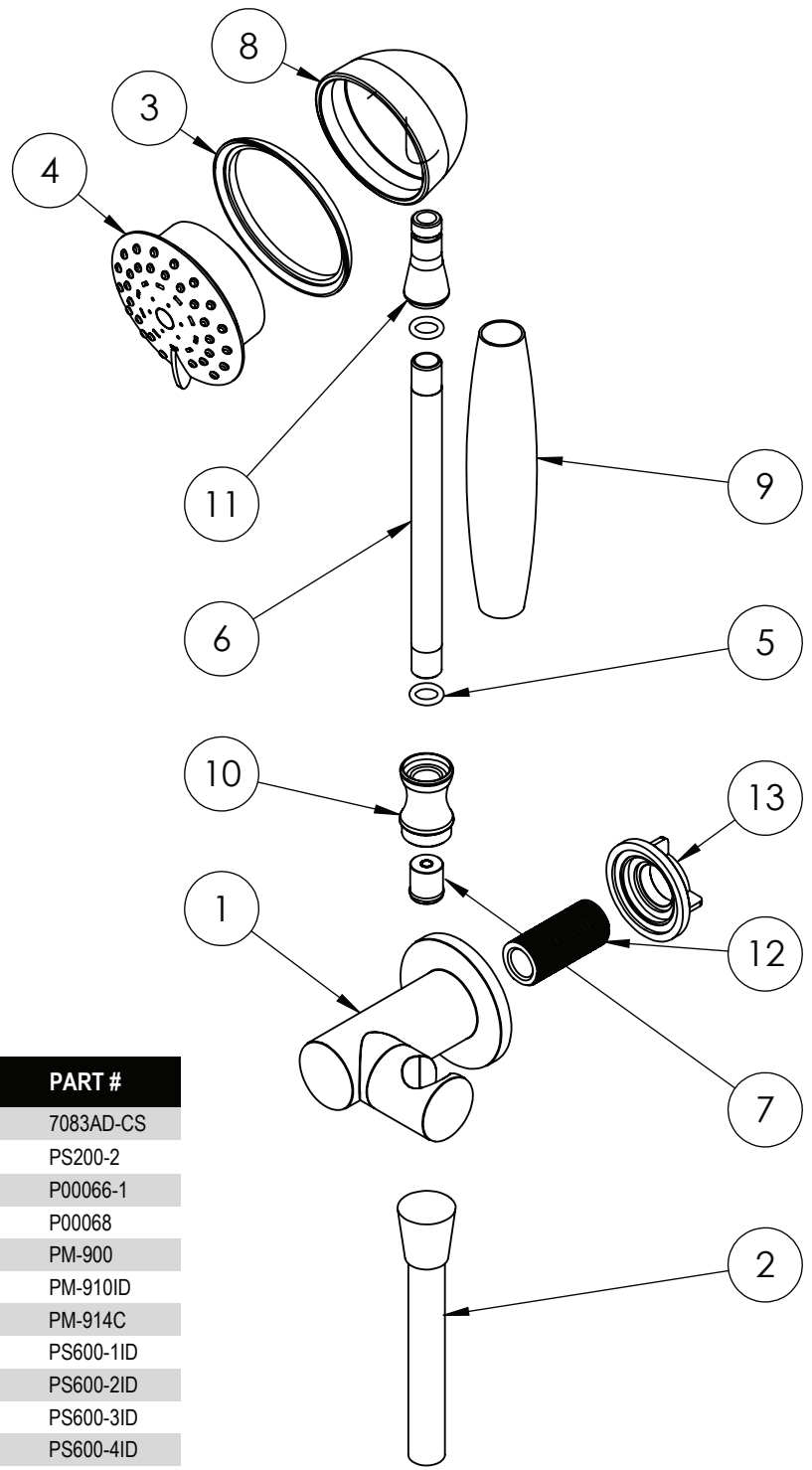

#	PART DESCRIPTION	PART #
1	Designer Round Common Adjustable Bracket	7083AD-CS
2	Hose Kit	PS200-2
3	Copper Plated Cover Ring	P00066-1
4	Hand Held Mechanism	P00068
5	O-Ring	PM-900
6	Inlet Tube	PM-910ID
7	Flow Restrictor w/ Check Valve 1.86 GPM	PM-914C
8	All Brass Handheld Shower Head	PS600-11D
9	Hand Held Brass Handle	PS600-21D
10	Hose Connection Coupler	PS600-31D
11	Handheld Connector	PS600-41D
12	1/2" Male Nipple Adaptor for Body Spray & Pot Filler	PM-730-DIS
13	Mounting Nut	PM-505

* Please specify the finish when ordering the part.

The measurements shown are for reference only. Products and specifications shown are subject to change without notice.

www.santecfaucet.com | P: 310.542.0063 F: 310.542.5681



FINISH CARE INFORMATION

WARNING: Do not clean your SANTEC product with ammonia (Window cleaner), bleach, soap, acids, abrasives, harsh polish, harsh cleaners, a coarse surfaced cloth, coarse sponge, or any type of scouring pad. Doing so may ruin your faucet finish and/or void the warranty.

Thank you for making SANTEC a part of your lifestyle and luxury spa experience. Our products have been created as works of enduring quality and sophisticated design.

Luxurious finishes need proper care and attention, so in order to understand how to properly clean your distinctive luxury finish, please refer to the finish care information below:

Your SANTEC product can be identified in one of two categories: clear coated finishes or non-clear coated finishes. Clear coated finishes are more scratch-sensitive and are more reactant to harsh cleaning chemicals than non-clear coated finishes. Once you have identified the specific luxury finish of your SANTEC product, please follow the important corresponding care instructions.

CLEAR COATED FINISHES

We recommend that all faucets, drains, etc., be gently wiped dry with a soft cloth after use to avoid water spotting and water deposit build-up. A mild liquid hand soap may be used occasionally if desired. Use of a non-abrasive carnauba wax will add protection to the finish and should be used if the faucets will not be dried after use. For clear coated finishes, it is recommended to clean your product weekly with a soft moist cloth.

NON-CLEAR COATED FINISHES

We recommend that all faucets, drains, etc., be gently wiped dry with a soft cloth after use to avoid water spotting and water deposit build-up. A mild liquid hand soap may be used occasionally if desired. Use of a non-abrasive carnauba wax is occasionally required and will add protection to the finish if the faucets will not be dried after use.

TO OBTAIN WARRANTY SERVICE

Please read 'WHAT IS COVERED BY OUR WARRANTY' and 'EXCLUSIONS AND LIMITATIONS OF WARRANTY' sections to understand what is and what is not covered. Please have ready the proof of purchase (original sales receipt), description of the problem, and carefully package the product or defective part with postage prepaid. Then, please contact your local SANTEC Showroom or write to SANTEC Technical Services.



LIFETIME LIMITED WARRANTY

SANTEC is committed to enhancing your bathroom experience by creating luxury products that will provide enduring satisfaction. Every effort has been made to satisfy the highest standards of design and production, to create lasting peace of mind for our customers. We provide the following limited warranties on our products:

LENGTH OF WARRANTY & WHO IS COVERED BY OUR WARRANTY

This warranty extends to the original consumer purchaser only and extends for as long as the original purchaser owns the product and the home in which the product is installed.

WHAT IS COVERED BY OUR WARRANTY

1. **FINISHES:** SANTEC Polished Chrome, Polished Nickel and Satin Nickel finishes carry a Lifetime Limited warranty against manufacturing defects and tarnish to the original purchaser. All other finishes carry a ten (10) year limited warranty against manufacturing defects and tarnish to the original purchaser only.
2. **CARTRIDGES:** Santec cartridges carry a lifetime limited warranty, with the exception of thermostatic and pressure balanced cartridges, which carry a three (3) year limited warranty against manufacturing defects to the original purchaser.
3. **PARTS:** Santec parts carry a 10-year limited warranty against manufacturing defects, to the original purchaser.

EXCLUSIONS & LIMITATIONS OF WARRANTY

This warranty does not cover:

1. Damage due to negligence, accident, abuse, improper installation, or improper maintenance such as, but not limited to: heat from soldering during installation, the use of plumber's putty, damage from tools used during installation, the use or exposure to chemicals or cleaning products either abrasive or non-abrasive, or the use of any cleaning tool or product other than a soft, clean cloth. Reverse osmosis may also shorten the life of the finish.
2. Changes in the finish or in the product due to normal wear or aging does not cover any products or parts which have been altered or used in a manner not typical for the product.
3. Loss, damages, or expense, incidental or consequential whatsoever, originating from the purchase, installation, use, repair, failure, or replacement of any SANTEC product or part, allowed by law.
4. Commercial and/or Industrial installations and use of the product.
5. This warranty does not include labor, travel charges, or any costs incurred for repair, removal, installation, servicing, diagnosing, or handling of either defective or replacement parts.
6. Damage or deterioration caused by environmental impacts.

SANTEC reserves the product components of the covered product will be repaired, refinished, or replaced at the sole discretion of SANTEC. SANTEC reserves the right to examine any product claimed defective prior to any warranty claim being accepted or processed, at its sole discretion. This warranty gives you specific legal rights and you may have other rights which may vary from state to state.

The measurements shown are for reference only. Products and specifications shown are subject to change without notice.

www.santecfaucet.com | P: 310.542.0063 F: 310.542.5681