

**CODE NUMBER**

3919050

**DESCRIPTION**

1.0 gpf, Rough Brass Finish, Stainless Steel Wall Plate Finish, Single Flush, 3.75 L Dimension, Standard (not included, order separately) Wall Box, Royal® Concealed Manual Urinal Flushometer.

**DETAILS**

- Flush Volume: 1.0 gpf (3.8 Lpf)
- Finish: Rough Brass (RB)
- Wall Plate Finish: Stainless Steel (BSS)
- Valve: Diaphragm
- Valve Body Material: Semi-red Brass
- Fixture Type: Urinal
- Fixture Connection: Top
- Rough-In Dimension: 13 ½" (343mm)
- Spud Coupling: ¾" (19mm)
- Supply Pipe: ¾" (19mm)
- L Dimension: 3 ¾" (95mm) (3-3/4-LDIM)
- Wall Box: Standard (not included, order separately)

**FEATURES**

- Royal®, Regal® and Sloan® Prison Flushometers feature all the performance benefits of standard concealed, diaphragm model Flushometers with added durability to withstand rough environments
- Flush volumes as low as 0.5 gpf/1.9 Lpf meet water-efficiency goals
- Push button-activated Flushometers intended for use with stainless-steel urinal fixtures from various manufacturers
- PERMEX synthetic rubber diaphragm with Dual Filtered Fixed Bypass
- Valve body, Cover, Tailpiece and Control Stop shall be in compliance with ASTM Alloy Classification for Semi-Red Brass
- Valve shall be in compliance to the applicable sections of ASSE 1037.



**COMPLIANCES & CERTIFICATIONS**



(cUPC Certified, BAA Compliant)

**RECOMMENDED SPECIFICATION**

Valve Body, Cover, Tailpiece and Control Stop shall be in conformance with ASTM Alloy Classification for Semi- Red Brass. Valve shall be in compliance with the applicable sections of ASSE 1037 and ANSI/ASME 112.19.2.

**VALVE OPERATING PRESSURE (FLOWING)**

15–80 PSI (103–552 kPa). Specific fixtures may require greater minimum flowing pressure - consult manufacturer requirements.

**DOWNLOADS**

- [Sloan Stainless Steel Installation Instructions](#)
- [Control Stop Repair and Maintenance Guide](#)
- [Flush Connections Flanges Repair and Maintenance Guide](#)
- [Tail Piece Repair and Maintenance Guide](#)
- [Royal Flushometers Repair and Maintenance Guide](#)
- [Additional Downloads](#)

**NOTES**

All information contained within this document subject to change without notice.

Looking for other variations of the ROYAL 613 product? [View the general spec sheet with all options.](#)

[Find a compatible urinal](#) for this flushometer.

[Find a compatible water closet](#) for this flushometer.

**Sloan 10500 Seymour Ave, Franklin Park, IL 60131**

Phone: 800.982.5839 • Fax: 800.447.8329 • [sloan.com](http://sloan.com)

**ROUGH-IN**

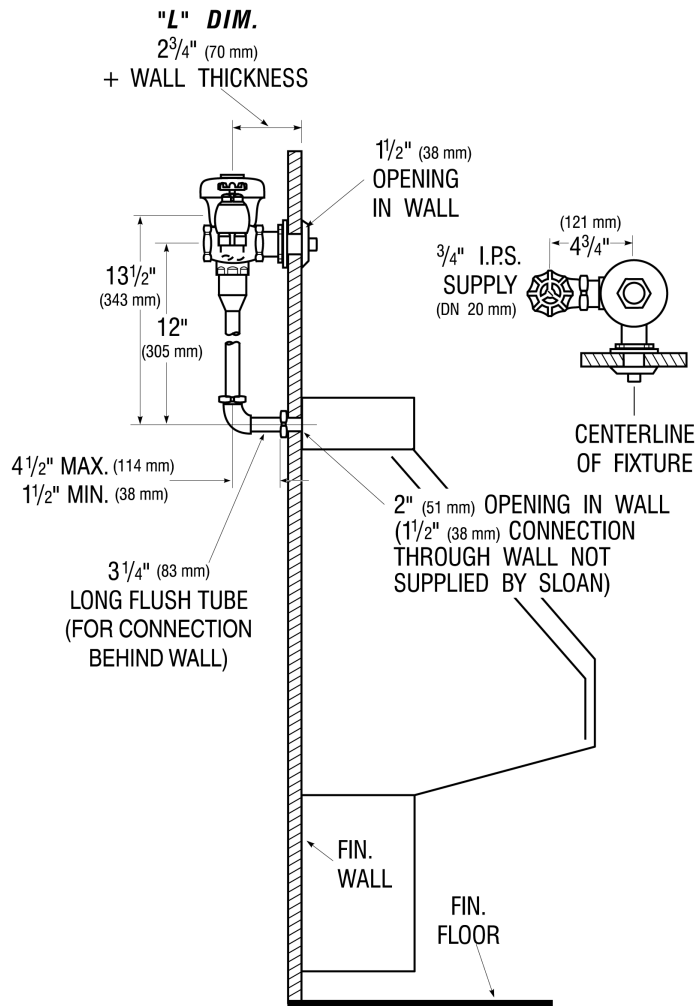

Sloan 10500 Seymour Ave, Franklin Park, IL 60131  
Phone: 800.982.5839 • Fax: 800.447.8329 • [sloan.com](http://sloan.com)