

**CODE NUMBER**

3918106

**DESCRIPTION**

1.6 gpf, Rough Brass Finish, Single Flush, 8.75 L Dimension, Royal® Concealed Manual Flushometer.

**DETAILS**

- Flush Volume: 1.6 gpf (6.0 Lpf)
- Finish: Rough Brass (RB)
- Valve: Diaphragm
- Valve Body Material: Semi-red Brass
- Fixture Type: Water Closet
- Fixture Connection: Rear
- Rough-In Dimension: 16" (406mm)
- Spud Coupling: 1 ½" (38mm)
- Supply Pipe: 1" (25mm)
- L Dimension: 8 ¾" (222mm) (8-3/4-LDIM)

**FEATURES**

- PERMEX® Synthetic Rubber Diaphragm with Dual Filtered Fixed Bypass
- Metal Direct Acting, Non-Hold-Open Push Button with a Triple Seal Handle Packing
- Vacuum Breaker
- Non-Hold-Open Handle, Fixed Metering Bypass and No External Volume Adjustment to Ensure Water Conservation
- 1" I.P.S. Wheel Handle Bak-Chek® Angle Stop
- Diaphragm, Stop Seat and Vacuum Breaker to be molded from PERMEX® rubber compound for Chloramine resistance
- Elbow Flush Connection and Coupling for 11/2" NPT Back Inlet (for connection in the pipe chase — flush connection through the wall not provided by Sloan)



**COMPLIANCES & CERTIFICATIONS**



(cUPC Certified, BAA Compliant)

**RECOMMENDED SPECIFICATION**

Valve Body, Cover, Tailpiece and Control Stop shall be in conformance with ASTM Alloy Classification for Semi- Red Brass. Valve shall be in compliance with the applicable sections of ASSE 1037 and ANSI/ASME 112.19.2.

**VALVE OPERATING PRESSURE (FLOWING)**

15–80 PSI (103–552 kPa). Specific fixtures may require greater minimum flowing pressure - consult manufacturer requirements.

**DOWNLOADS**

- [Sloan Stainless Steel Installation Instructions](#)
- [Control Stop Repair and Maintenance Guide](#)
- [Flush Connections Flanges Repair and Maintenance Guide](#)
- [Tail Piece Repair and Maintenance Guide](#)
- [Royal Flushometers Repair and Maintenance Guide](#)
- [Concealed Flushometers Repair and Maintenance Guide](#)
- [Additional Downloads](#)

**NOTES**

All information contained within this document subject to change without notice.

Looking for other variations of the ROYAL 603 product? [View the general spec sheet with all options.](#)

[Find a compatible urinal](#) for this flushometer.

[Find a compatible water closet](#) for this flushometer.

**Sloan 10500 Seymour Ave, Franklin Park, IL 60131**

Phone: 800.982.5839 • Fax: 800.447.8329 • [sloan.com](http://sloan.com)

**ROUGH-IN**

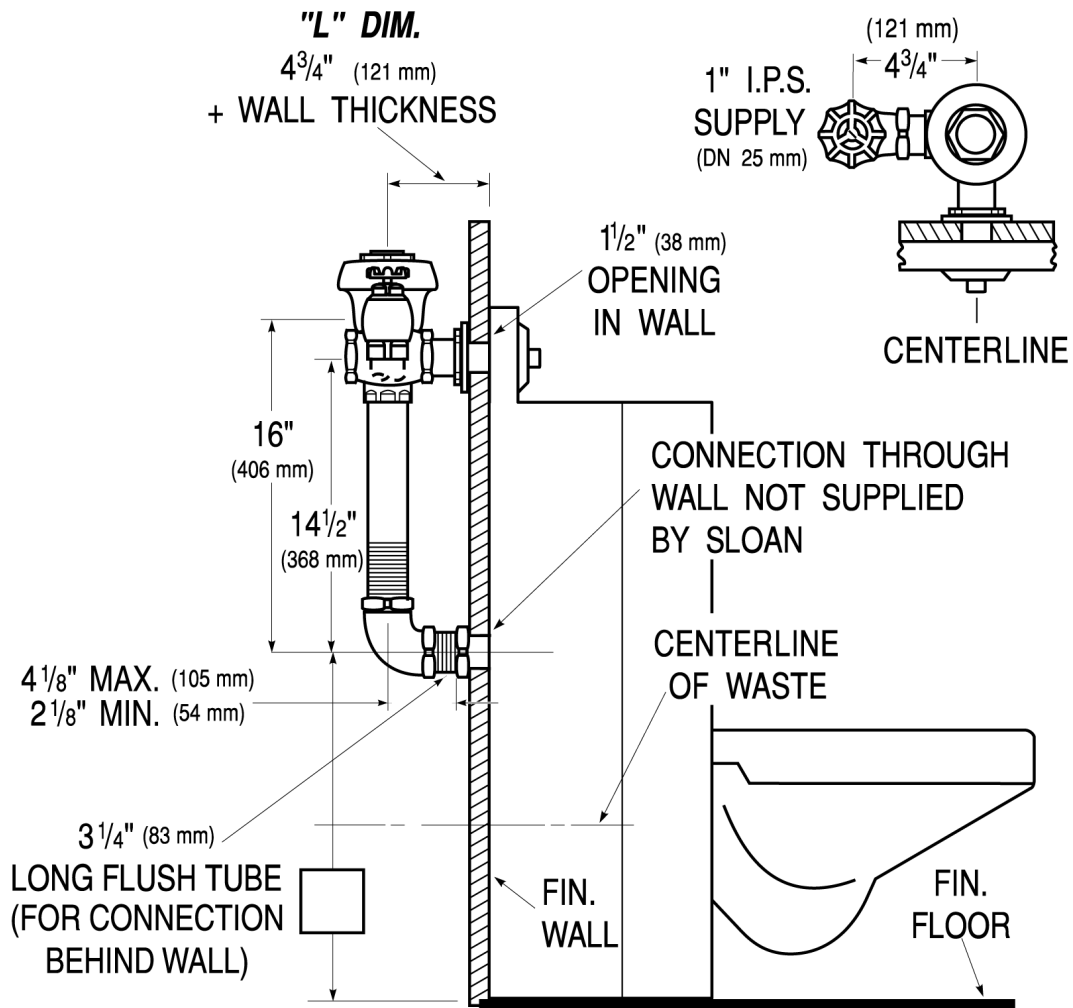

Sloan 10500 Seymour Ave, Franklin Park, IL 60131  
Phone: 800.982.5839 • Fax: 800.447.8329 • [sloan.com](http://sloan.com)