

**CODE NUMBER**

3379056

**DESCRIPTION**

2.4 gpf, Dual-Filtered Fixed Bypass Diaphragm, Polished Chrome Finish, Single Flush, No Control Stop, Electrical Override, Battery, Sloan® Exposed Sensor Water Closet Retrofit Flushometer.

**DETAILS**

- Flush Volume: 2.4 gpf (9.1 Lpf)
- Finish: Polished Chrome (CP)
- Power Type: Battery
- Valve: Diaphragm
- Bypass: Dual-Filtered Fixed Bypass Diaphragm (DFB)
- Valve Body Material: Semi-red Brass
- Fixture Type: Water Closet
- Fixture Connection: Top spud
- Override: Electrical (OR)
- Control Stop: No (XD)

**FEATURES**

- High chloramine resistant PERMEX synthetic rubber diaphragm with Linear Filtered Bypass and Vortex Cleansing Action
- Valve body, Cover, Tailpiece and Control Stop shall be in compliance with ASTM Alloy Classification for Semi-Red Brass
- Valve shall be in compliance to the applicable sections of ASSE 1037.



**COMPLIANCES & CERTIFICATIONS**



(ADA Compliant, cUPC Certified)

**RECOMMENDED SPECIFICATION**

Valve Body, Cover, Tailpiece and Control Stop shall be in conformance with ASTM Alloy Classification for Semi- Red Brass. Valve shall be in compliance with the applicable sections of ASSE 1037 and ANSI/ASME 112.19.2.

**VALVE OPERATING PRESSURE (FLOWING)**

15–80 PSI (103–552 kPa). Specific fixtures may require greater minimum flowing pressure - consult manufacturer requirements.

**DOWNLOADS**

- [Optima Plus Valve Installation Instructions](#)
- [Optima Plus Valve \(SP\) Installation Instructions](#)
- [Control Stop Repair and Maintenance Guide](#)
- [Flush Connections Flanges Repair and Maintenance Guide](#)
- [Tail Piece Repair and Maintenance Guide](#)
- [Additional Downloads](#)

**NOTES**

All information contained within this document subject to change without notice.

Looking for other variations of the SLOAN RESS-C product?  
[View the general spec sheet with all options.](#)

[Find a compatible urinal](#) for this flushometer.

[Find a compatible water closet](#) for this flushometer.

**Sloan 10500 Seymour Ave, Franklin Park, IL 60131**

Phone: 800.982.5839 • Fax: 800.447.8329 • [sloan.com](http://sloan.com)

**ROUGH-IN**

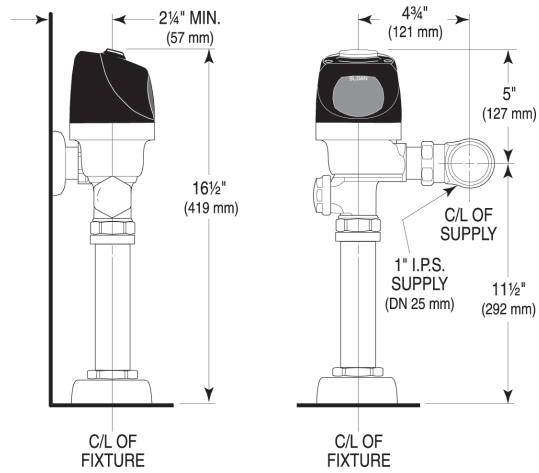
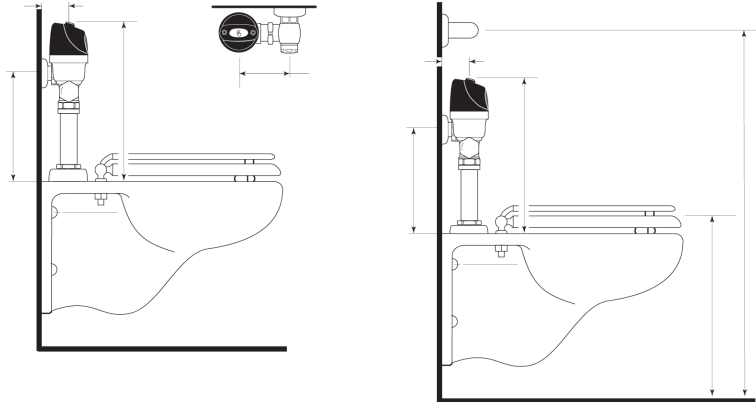

**Sloan 10500 Seymour Ave, Franklin Park, IL 60131**

Phone: 800.982.5839 • Fax: 800.447.8329 • [sloan.com](http://sloan.com)