

FEATURES:

- All brass construction.
- Available in all Sigma finishes. Warranty varies according to finish selection.
- Mounting brackets and screws are supplied.

Accessories

Series 66
Single Post Paper Holder
1.66SP00

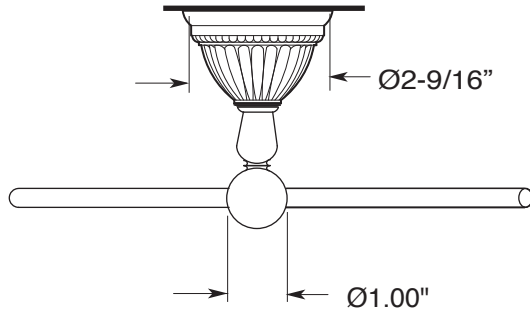

TOP VIEW

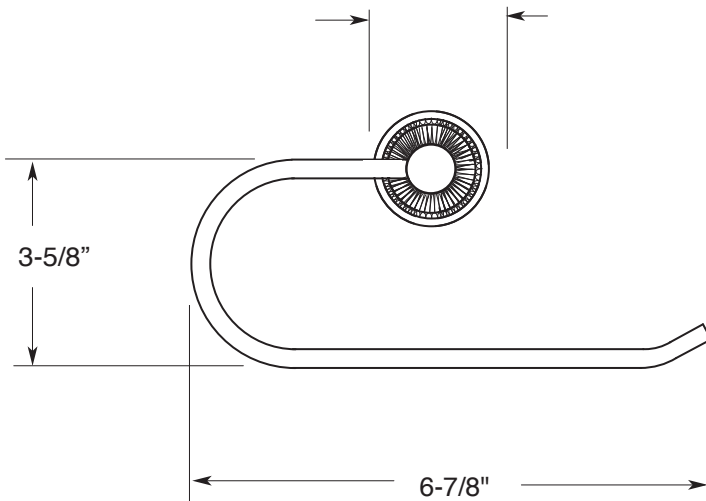

FRONT VIEW

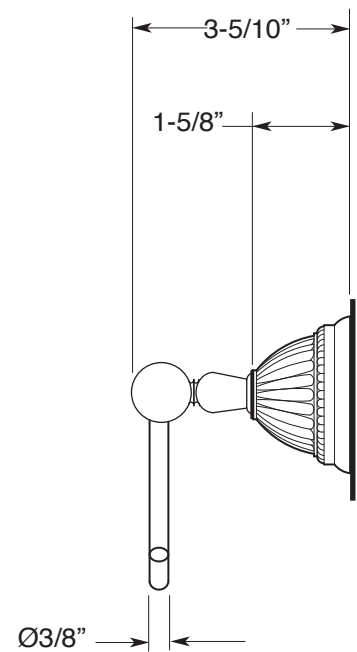

SIDE VIEW

Note: Measurements are subject to change or cancellation. No responsibility is assumed for use of superseded or voided pages.