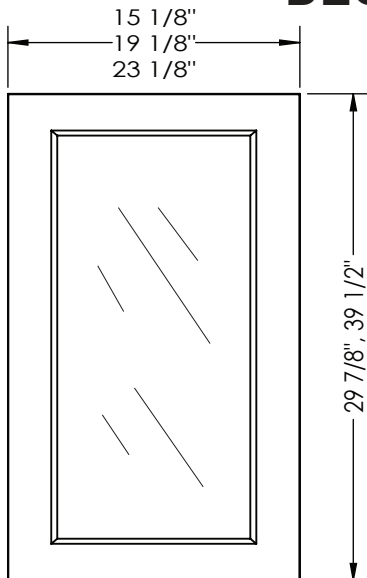


## DECORATIVE FRAMED WALL MIRROR INSTALLATION INSTRUCTIONS



### General Notes

Unpack the mirror and check the box for all hardware and loose parts as follows:

- Mirror
- Hardware Bag

Be sure you have all the contents listed above and in the **Parts List** on page 2.

Save these instructions for future use and reference.

An improper installation voids the warranty. Installed mirrors cannot be returned.

If you experience any problems with your mirror, contact your dealer or Robern directly.

**Robern • 701 N. Wilson Ave • Bristol, PA 19007**  
**1-800-877-2376 • FAX 1-267-540-2053**

*Limited Warranty — One Year Term (see page 2)*

### Installing the Mirror

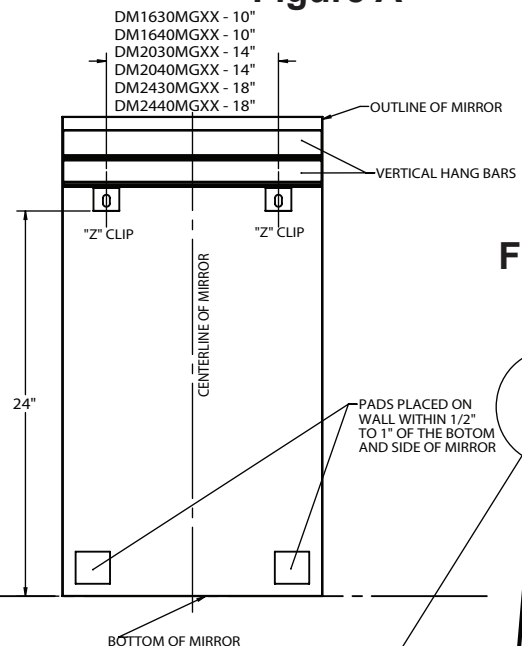
1. Determine the placement of the two "Z" clips (see Figure A).
  - Carefully select the mirror location
  - Mark the bottom and side locations of the mirror on the wall with a pencil
  - Use Figure A to mark the "Z" clip locations
2. Install the two "Z" clips
  - Place the "Z" clips in the locations shown in Figure A using the supplied washers and SS674 #10X2" (50.8 mm) screws

Note: You must use the supplied plastic anchors when there is no wall stud at the "Z" clip location. See Poly-set Anchor Instructions on page 2.

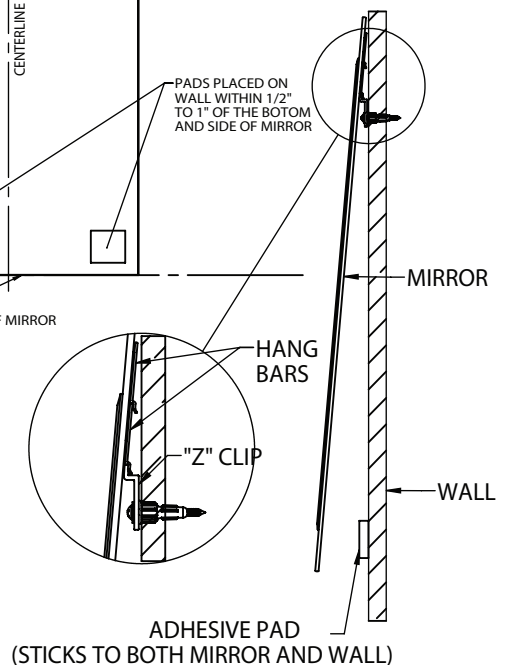
3. Peel the paper backing from one side of the 2"X2" (50.8 mm) double-sided adhesive pads and adhere the pads to the back inside corners of the glass part of the mirror as shown in Figure A.
4. Hang the mirror on the "Z" clips (see Figure B for location of hanging bars). If the mirror needs to be repositioned slightly, adjust the "Z" clips up or down until the mirror is level.
5. Tilt the bottom of the mirror out slightly (Figure B) and peel the backing paper from the other side of the adhesive pads. Push the mirror against the wall firmly until the pads stick to

the wall.

**Figure A**

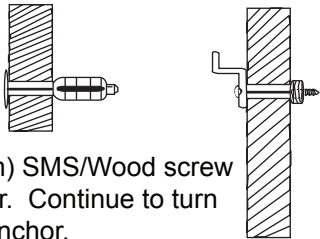


**Figure B**

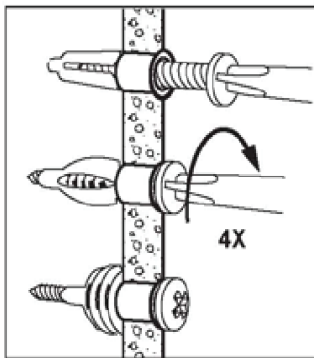


## Poly-set Anchor Instructions for Hollow Walls

1. Drill 9/32" (7.1 mm) hole and insert anchor until flange is flush.



2. Insert #10 X 2" (50.8 mm) SMS/Wood screw through bracket and anchor. Continue to turn screw to fully expand the anchor.



## Cleaning and Care

**NOTE:** Under no circumstances should an ammonia-based cleaner be used on mirrors.

When cleaning the mirror surface use only a lint-free polishing cloth for cleaning. To remove stubborn stains slightly dampen the cloth with water or rubbing alcohol.

When cleaning the metal frame used only a damp cloth.

**NOTE:** Do not use abrasive cleansers on any part of the mirror.

## Limited Warranty One Year Term

ROBERN warrants to the original purchaser that, it will, at its election repair, replace or make appropriate adjustment to products made by this company shown to have significant defects in material or workmanship which are reported to ROBERN in writing within one (1) year from the date of delivery. ROBERN is not responsible for installation costs.

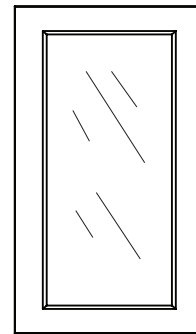
The warranty is void in the event the product is damaged in transit, or if damage or failure is caused by abuse, misuse, abnormal usage, faulty installation, damage in an accident, improper maintenance, or any repairs other than those authorized by ROBERN. At the expiration of the one year warranty period, ROBERN shall be under no further obligation under any warranty, expressed or implied, including the implied warranty of merchantability.

ROBERN shall not be liable for any consequential damages arising out of or in connection with the use or performance of its products. Some states do not allow limitations on how long an implied warranty lasts or do not allow the exclusion or limitation of incidental or consequential damages, so the above exclusion may not apply to you.

Any liability against ROBERN under any implied warranty, including the warranty of merchantability, is expressly limited to the terms of this warranty. Permission to return any merchandise under this warranty must be authorized by ROBERN and returned prepaid by the purchaser. Claims under this warranty should be sent directly to your dealer.

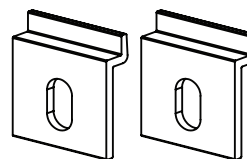
## Parts List

1. Mirror  
Refer to Model Number designations to determine which mirror was ordered

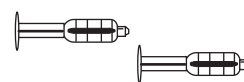


2. Hardware Bag [BAGRF\*] Contains the Following:

- 2 "Z" Clips [R027011HM\*]



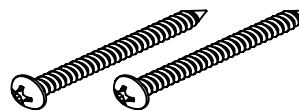
- 2 Plastic Anchors [SS680\*]



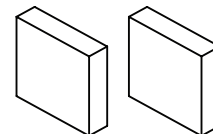
- 2 Washers [SS164\*]



- 2 SMS/Wood Screws #10 X 2" (50.8 mm) [SS674\*]



- 2 Adhesive Pads [SS162\*]



\* Item Part Number