

MATERIALS NEEDED:

PHILLIPS SCREWDRIVER	WOOD SCREWS
LEVELING TOOL	HOLLOW WALL ANCHORS
DRILL	STUD FINDER
DRYWALL SAW	

Step 1 : Using a pencil and a level, draw the perimeter of the backside of the cabinet in the desired wall location.

See Figure 1.

Figure 1.

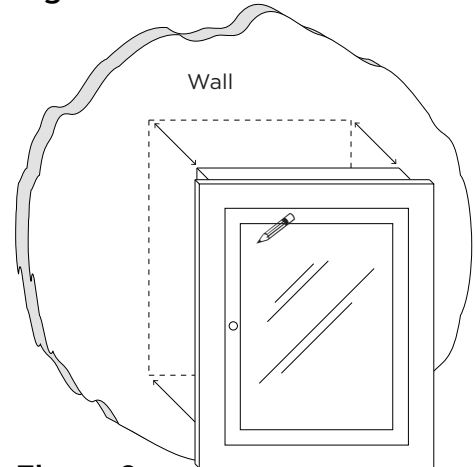

Step 2 : Cut a hole along the drawn perimeter using the appropriate tools.

See Figure 2.

Figure 2.

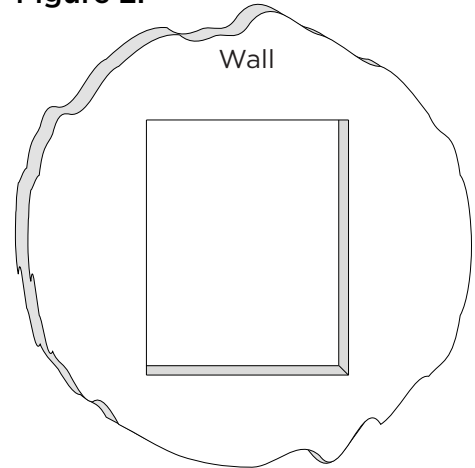

ROUGH OPENING SIZE:
 17-1/4"(43.8cm) W
 x
 28-1/4"(71.8cm) H

Step 3 : Create a frame using frame studs and frame blocks that will fit the width and height of the backside of your medicine cabinet

See Figure 3.

Figure 3.

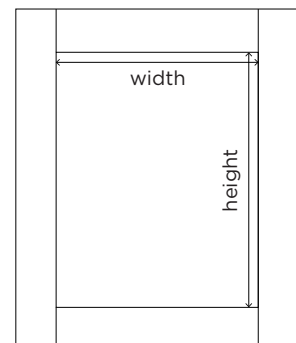

Step 4 : Carefully complete the frame with studs and frame blocks inside the cutout, making sure the edges align.

See Figure 4.

Figure 4.

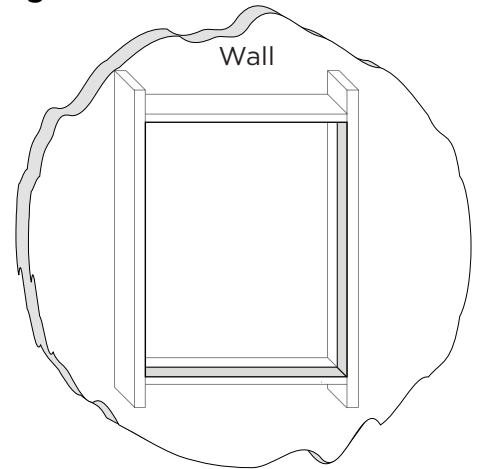

Step 5 : Place an appropriate amount of wood glue on the inner sides of the frame. Position the cabinet into the cutout and into the frame.

See Figure 5.

Figure 5.

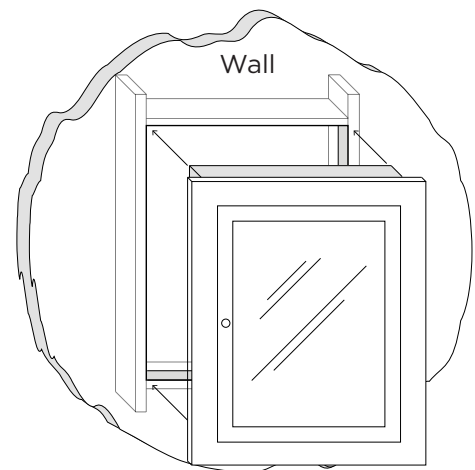

Step 6 : The finished installation should have the medicine cabinet front concealing the edges of your wall cutout.

See Figure 6.

Figure 6.

