

PERFORMANCE PLATINUM™



The new degree of comfort®

PERFORMANCE PLATINUM™ ProTerra Hybrid Electric with LeakGuard™ is the most efficient water heater available

Efficiency

- Up to 4.0 UEF reduces operating cost
- ENERGY STAR® rated

Performance

- Delivers hot water faster than most standard electric water heaters
- Ambient operating range: 37-145° F is widest in class, offering more days of HP operation annually; designed to meet Northern Climate Spec (Tier 4)

Easy Installation

- Easy access side connections
- Quick access to electrical junction box
- Easily replaces a standard electric water heater

Integration

- LED Screen with built-in water sensor alert with audible alarm
- Integrated EcoNet® WiFi-connected¹ technology (2.4 GHz only) and free mobile app gives users control over water systems, allowing for customizable temperature, vacation settings, energy savings and system monitoring at home or away. Visit Rheem.ca/hybridsolutions

LEAKGUARD™
WATER SHUT-OFF VALVE

- Integrated leak detection and prevention system with factory installed auto water shut-off valve limits leaks to no more than 20 ounces of water²
- LeakSense™ Built-in Leak Detection System detects any leak large or small, internal or external³

Operation Modes

- Energy Saver
- Heat Pump
- High Demand
- Electric
- Vacation/Away: 2-28 days (or placed on hold indefinitely)

Plus...

- Premium grade anode rod with resistor extends the life of the tank
- 3/4" NPT water inlet and outlet; 3/4" condensate drain connections
- Incoloy stainless steel resistor elements
- Dry-fire protection
- Easy access, top mounted washable air filter
- 2" Non-CFC foam insulation
- Enhanced flow brass drain valve
- Temperature and pressure relief valve installed
- Design certified to NSF/ANSI 372 (Lead Content)

Warranty

- 10-Year limited tank and parts warranty
See Residential Warranty Certificate for complete information



PERFORMANCE PLATINUM Hybrid

40, 65 and 80 US Gallon Capacities
208-240 Volt / 1 PH Electric



LEED Points = 3

See specifications chart on back.

¹WiFi broadband internet connection required. ²Source: Rheem Leak-Sensing Data; testing under a vacuum lock using 50-gallon tank, no expansion tank, average tank pressure of 40 psi, assuming no additional faucets are opened. ³Water leaks from the heater only, as tested across scenarios including a minimum of 5.5mL/hr volume leak rate, using most common installation scenarios.



The new degree of comfort.™

PERFORMANCE PLATINUM™ Hybrid Specifications

Fuel Type	Desc.	Nominal US Gallon Cap.	Rated US Gallon Cap.	IMP. GALS	Model Number	Electric Breaker Size	Uniform Energy Factor (UEF)	Element Wattage	Compressor Btu/H	First Hr. Rating G.P.H.	Recovery in G.P.H. 90° F Rise	Tank Height A	Diam. B	Ht. to Cold Inlet & Drain Valve	Ht. to Hot Outlet & T&P	Unit Wt. (LBS.)	Approx. Ship Wt. (LBS.)	
30 AMPS – SHUT OFF																		
Electric	Tall	40	36	33	CXE40T10HS45U0	30	3.75	4,500	4200	60	26	63"	20-1/4"	3-5/8"	39-5/8"	157	174	
Electric	Tall	65	59	54	CXE65T10HS45U0	30	3.85	4,500	4200	75	27	65"	24-1/4"	3-7/8"	42-3/8"	225	262	
Electric	Tall	80	72	67	CXE80T10HS45U0	30	4.00	4,500	4200	87	27	75"	24-1/4"	3-7/8"	42-3/8"	244	281	

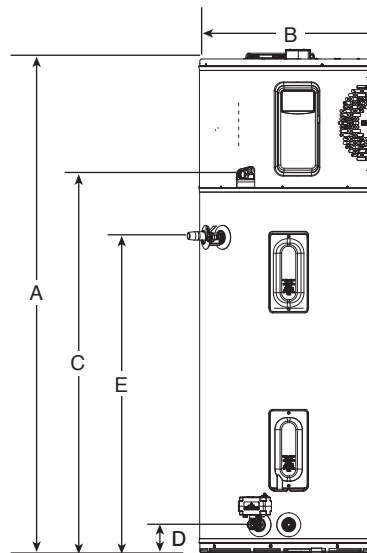
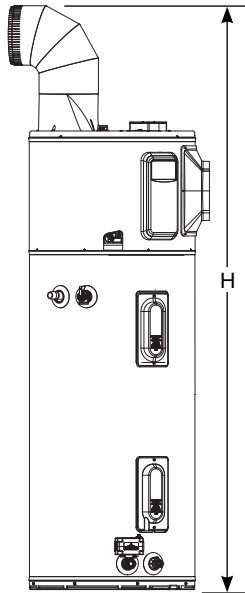
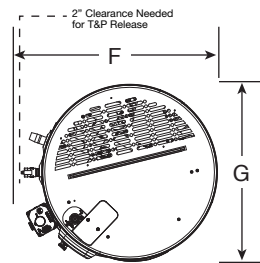
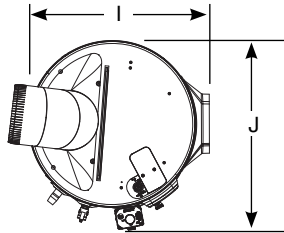

DESCRIPTION			DIMENSIONS (SHOWN IN INCHES)									
NOMINAL US GALLON CAPACITY	IMP. GALS	MODEL NUMBER	A	B	C	D	E	F	G	H	I	J
40	33	CXE40T10HS45U0	62-5/16	20-1/4	47	3-5/8	39-5/8	23-3/8	20-1/2	78-7/8	22-3/8	23-1/4
65	54	CXE65T10HS45U0	64-3/16	24-1/4	49	3-7/8	42-3/8	27-1/2	24-5/8	81-1/8	26-1/2	27-3/8
80	67	CXE80T10HS45U0	74-3/16	24-1/4	59	3-7/8	42-3/8	27-1/2	24-5/8	91	26-1/2	27-3/8

Hybrid Water Heater Installation Guidelines to Provide Optimal Efficiency

Heater: Not Ducted

Room size: Larger than 700 ft³ (e.g. 7' x 10' x 10').
 Requirements: No additional ventilation needed.

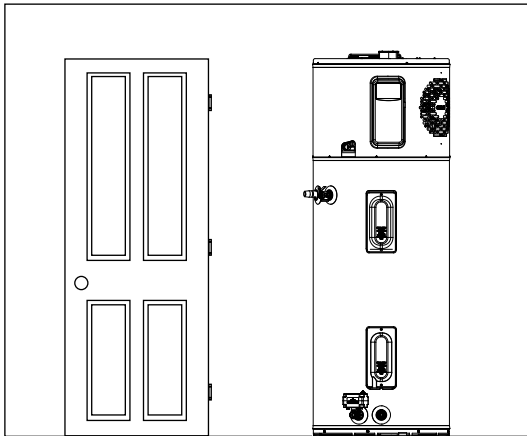

Heater: Not Ducted

Room size: Smaller than 700 ft³ (e.g. 7' x 10' x 10').
 Requirements: Full louvered door OR two louvers top and bottom. See below.

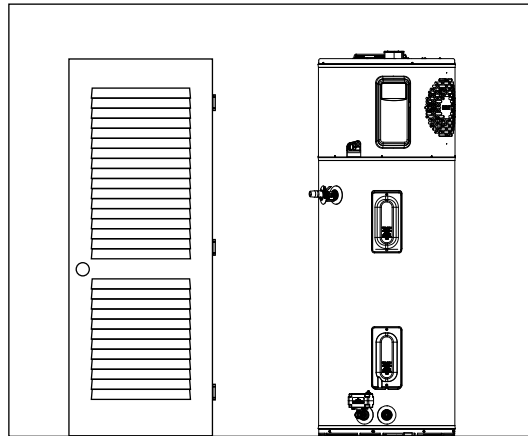

Heater: Not ducted

Room: Small Closet

Requirements: * Air gap under door equal to 18 in² (0.75" clearance).
 * Louver must be located the same height on door as the air exhaust on heater.
 * Heater air exhaust must be positioned towards louver within one foot of door.

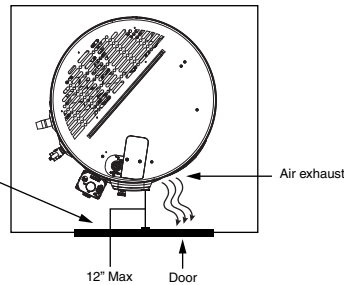
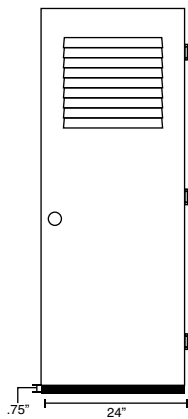

Heater: Ducted with inlet OR outlet duct

Room size: Any size room
 Requirements: Air gap under door equal to 18 in² (0.75" clearance)

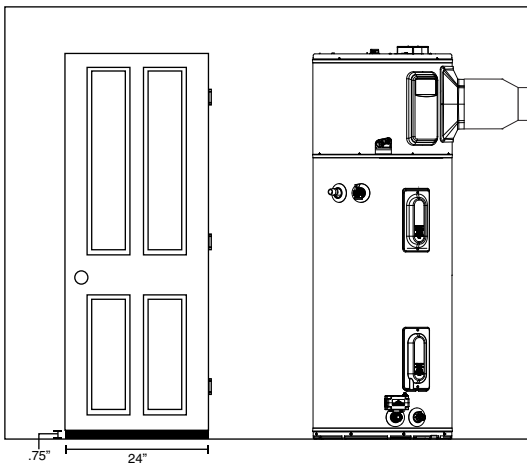

Heater: Ducted with inlet AND outlet duct

Room size: Any size room
 Requirements: No additional ventilation needed.

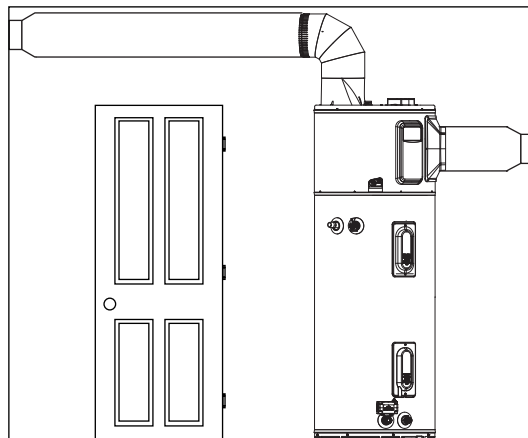

In keeping with its policy of continuous progress and product improvement, Rheem reserves the right to make changes without notice.