



The new degree of comfort.®

Rheem® Commercial Tankless Water Heater Submittal Sheet

Job Name: _____

Location: _____

Architect/Engineer: _____

Contractor/Plumber: _____

Water Heater Schedule: _____
(ex. WH-1 - WH-12)

Commercial Tankless Models

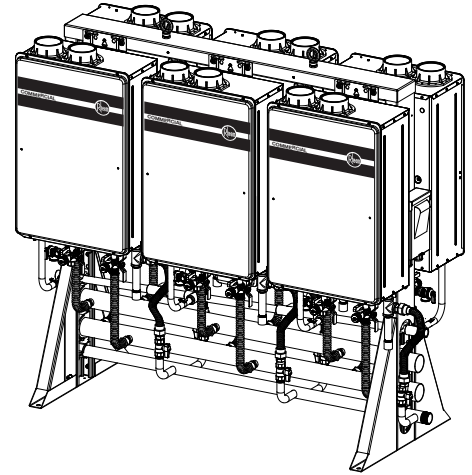

Rheem Commercial Tankless Water Heaters

TANKLESS MODEL	INDOOR NATURAL GAS	INDOOR LIQUID PROPANE	OUTDOOR NATURAL GAS	OUTDOOR LIQUID PROPANE
Model Number	RTGH-CM95DVLN	RTGH-CM95DVLP	RTGH-CM95XLN	RTGH-CM95XLP
Quantity Needed				

- Controls included
- Communication cables included
- Condensate neutralizer included
- Isolation and pressure relief valves included

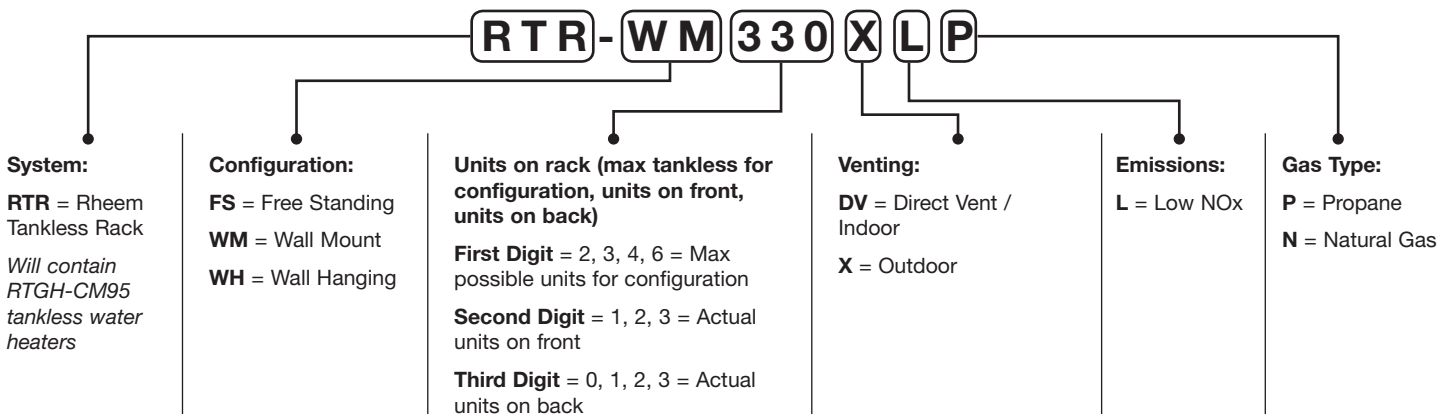

RHEEM COMMERCIAL TANKLESS SYSTEMS SUBMITTAL

Freestanding Tankless Rack System

Mounts to ground only, must be on the ground, can be any distance from the wall.

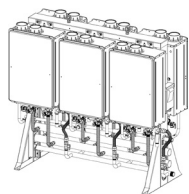
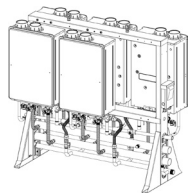
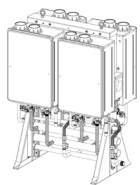
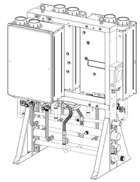
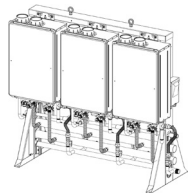
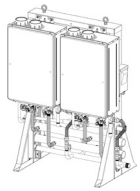
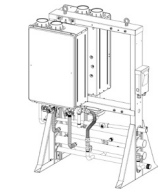

QTY.	MODEL NUMBER	NUMBER OF UNITS	SYSTEM DESCRIPTION	FUEL TYPE	LAYOUT
	RTR-FS411DVLN	2-Units	Indoor Free Standing	Nat. Gas	
	RTR-FS411XLN	2-Units	Outdoor Free Standing	Nat. Gas	
	RTR-FS411XVLP	2-Units	Outdoor Free Standing	LP Gas	
	RTR-FS420DVLN	2-Units	Indoor Free Standing	Nat. Gas	
	RTR-FS420XLN	2-Units	Outdoor Free Standing	Nat. Gas	
	RTR-FS420XLP	2-Units	Outdoor Free Standing	LP Gas	
	RTR-FS630DVLN	3-Units	Indoor Free Standing	Nat. Gas	
	RTR-FS630XLN	3-Units	Outdoor Free Standing	Nat. Gas	
	RTR-FS630XLP	3-Units	Outdoor Free Standing	LP Gas	
	RTR-FS421DVLN	3-Units	Indoor Free Standing	Nat. Gas	
	RTR-FS421XLN	3-Units	Outdoor Free Standing	Nat. Gas	
	RTR-FS421XLP	3-Units	Outdoor Free Standing	LP Gas	
	RTR-FS422DVLN	4-Units	Indoor Free Standing	Nat. Gas	
	RTR-FS422XLN	4-Units	Outdoor Free Standing	Nat. Gas	
	RTR-FS422XLP	4-Units	Outdoor Free Standing	LP Gas	
	RTR-FS632DVLN	5-Units	Indoor Free Standing	Nat. Gas	
	RTR-FS632XLN	5-Units	Outdoor Free Standing	Nat. Gas	
	RTR-FS632XLP	5-Units	Outdoor Free Standing	LP Gas	
	RTR-FS633DVLN	6-Units	Indoor Free Standing	Nat. Gas	
	RTR-FS633XLN	6-Units	Outdoor Free Standing	Nat. Gas	
	RTR-FS633XLP	6-Units	Outdoor Free Standing	LP Gas	

RHEEM COMMERCIAL TANKLESS SYSTEMS SUBMITTAL

Wall Hanging Tankless System

Mounts to wall only, can hang any distance above the ground.

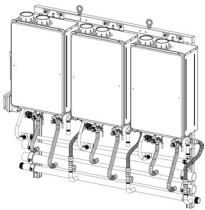
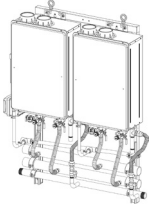

QTY.	MODEL NUMBER	NUMBER OF UNITS	SYSTEM DESCRIPTION	FUEL TYPE	LAYOUT
	RTR-WH220DVLN	2-Units	Indoor Wall Hanging	Nat. Gas	
	RTR-WH220XLN	2-Units	Outdoor Wall Hanging	Nat. Gas	
	RTR-WH220DVLP	2-Units	Indoor Wall Hanging	LP Gas	
	RTR-WH220XLP	2-Units	Outdoor Wall Hanging	LP Gas	
	RTR-WH330DVLN	3-Units	Indoor Wall Hanging	Nat. Gas	
	RTR-WH330XLN	3-Units	Outdoor Wall Hanging	Nat. Gas	
	RTR-WH330DVLP	3-Units	Indoor Wall Hanging	LP Gas	
	RTR-WH330XLP	3-Units	Outdoor Wall Hanging	LP Gas	

Wall Mount Tankless System

Mounts to wall and ground, must be on the ground, and against the wall.

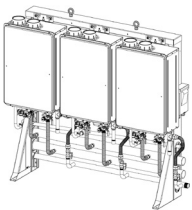
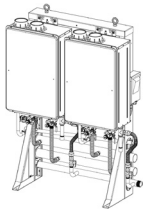

QTY.	MODEL NUMBER	NUMBER OF UNITS	SYSTEM DESCRIPTION	FUEL TYPE	LAYOUT
	RTR-WM220DVLN	2-Units	Indoor Wall Mount	Nat. Gas	
	RTR-WM220XLN	2-Units	Outdoor Wall Mount	Nat. Gas	
	RTR-WM220DVLP	2-Units	Indoor Wall Mount	LP Gas	
	RTR-WM220XLP	2-Units	Outdoor Wall Mount	LP Gas	
	RTR-WM330DVLN	3-Units	Indoor Wall Mount	Nat. Gas	
	RTR-WM330XLN	3-Units	Outdoor Wall Mount	Nat. Gas	
	RTR-WM330DVLP	3-Units	Indoor Wall Mount	LP Gas	
	RTR-WM330XLP	3-Units	Outdoor Wall Mount	LP Gas	

NOTES

RHEEM COMMERCIAL TANKLESS SYSTEMS SUBMITTAL

Back to Back Common Venting

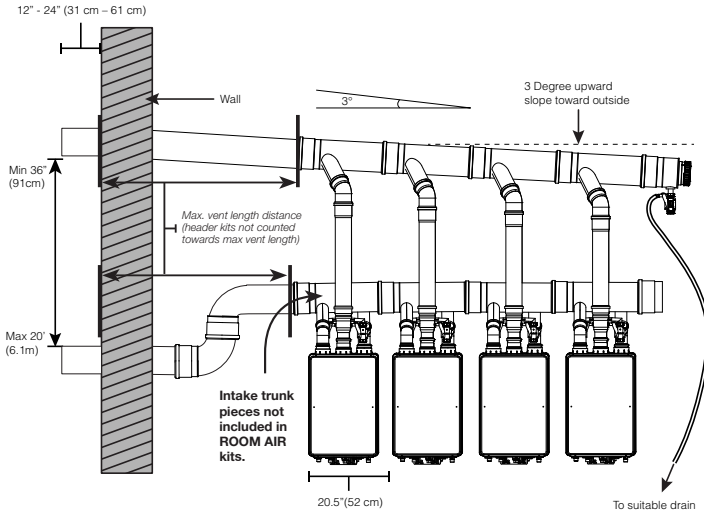

Diagrams illustrate horizontal intake and exhaust, vertical intake and exhaust also available, but not pictured.

QTY.	DIRECT VENT PART NO.	QTY.	ROOM AIR PART NO.	TRUNK DIAM.	NO. OF UNITS
	SP20912A		SP20913A	6"	2
	SP20912B		SP20913B		3
	SP20912C		SP20913C		4
	SP20914A		SP20915A	8"	2
	SP20914B		SP20915B		3
	SP20914C		SP20915C		4
	SP20914D		SP20915D		5
	SP20914E		SP20915E		6
	SP20914F		SP20915F		7
	SP20914G		SP20915G		8
	SP20916A		SP20917A	10"	2
	SP20916B		SP20917B		3
	SP20916C		SP20917C		4
	SP20916D		SP20917D		5
	SP20916E		SP20917E		6
	SP20916F		SP20917F		7
	SP20916G		SP20917G		8

Back to Back Venting Gas Chip

Inline Common Venting

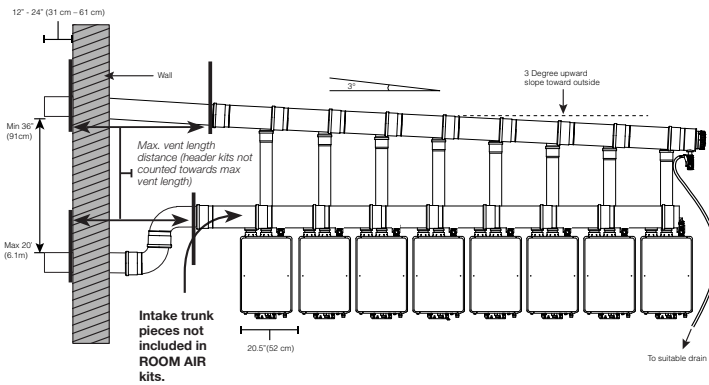

Diagrams illustrate horizontal intake and exhaust, vertical intake and exhaust also available, but not pictured.

ADDITIONAL ACCESSORIES

QTY.	DIRECT VENT PART NO.	QTY.	ROOM AIR PART NO.	TRUNK DIAM.	NO. OF UNITS
	SP20906A		SP20907A	6"	2
	SP20906B		SP20907B		3
	SP20906C		SP20907C		4
	SP20908A		SP20909A	8"	2
	SP20908B		SP20909B		3
	SP20908C		SP20909C		4
	SP20908D		SP20909D		5
	SP20908E		SP20909E		6
	SP20908F		SP20909F		7
	SP20908G		SP20909G		8
	SP20910A		SP20911A	10"	2
	SP20910B		SP20911B		3
	SP20910C		SP20911C		4
	SP20910D		SP20911D		5
	SP20910E		SP20911E		6
	SP20910F		SP20911F		7
	SP20910G		SP20911G		8
	SP20910H		SP20911H		9
	SP20910I		SP20911I		10
	SP20910J		SP20911J		10

In keeping with its policy of continuous progress and product improvement, Rheem reserves the right to make changes without notice.

Rheem Water Heating • 1115 Northmeadow Parkway, Suite 100
Roswell, Georgia 30076 • www.rheem.com

PRINTED IN U.S.A. 09/18 WP FORM NO. TK-RTR-SUBMIT