

SPECIFICATIONS

DESCRIPTION

- Patented valve technology with both thermostatic and pressure balance functionality
- Temperature and volume control
- 2 dedicated functions with no sharing between functions
- Rough-in valve sold separately
- Order R23 therm & pressure balance rough-in valve to complete
- Cartridge ships with trim set 0915
- CEC compliant
- Extension kits available, 1 1/4" EXT23KIT114 and 3/4" EXT23KIT34

CARTRIDGE

- 0-915

STANDARDS

- ASME A112.18.1

WARRANTY

- Most products or parts carry "Limited Warranties" against manufacturing defects. For US customers please visit houseofrohl.com/support and for Canadian customers please visit houseofrohl.ca/support for complete product and finish warranty.

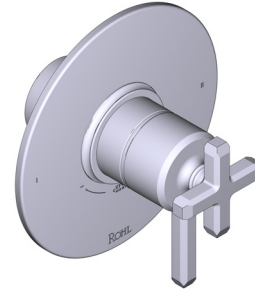

Apotheary™ 1/2" Therm & Pressure Balance Trim with 2 Functions (No Share)

MODELS: TAP44W1

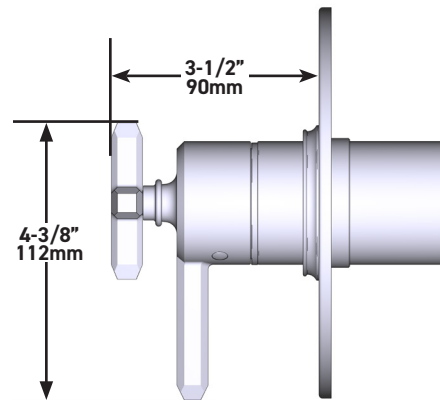
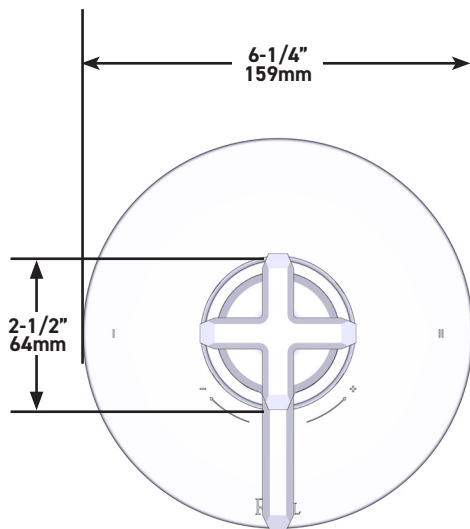

For warranty or additional information, contact:

U.S.A.
houseofrohl.com/support
1-800-777-9762

QUEBEC / MARITIMES / WESTERN CANADA
houseofrohl.ca/support
1-866-473-8442

ONTARIO
houseofrohl.ca/support
1-800-287-5354

Riobel

PERRIN & ROWE
LONDON



victoria ⊕ albert®

ROHL

SPÉCIFICATIONS

DESCRIPTION

- Technologie de soupape brevetée et fonctionnalités thermostatique et d'équilibrage de pression
- Commandes de température et de débit
- 2 fonctions distinctes, aucune fonction partagée
- Soupape de plomberie brute vendue séparément
- Commander une soupape de plomberie brute thermostatique à équilibrage de pression no R23 pour procéder à l'installation complète
- La cartouche est expédiée avec la trousse de garniture no 0915
- Conforme aux normes de la CEC
- Trusses de rallonge disponibles : la trousse no EXT23KIT114 de 1 1/4 po et la trousse no EXT23KIT34 de 3/4 po

CARTOUCHE

- 0-915

CERTIFICATIONS

- ASME A112.18.1

GARANTIE

- La plupart des produits ou pièces comprend des «garanties limitées» contre les défauts de fabrication. Pour les clients des États-Unis : veuillez consulter houseofrohl.com/support; Pour les clients du Canada : veuillez consulter houseofrohl.ca/support pour connaître les conditions complètes de la garantie des produits et finis.

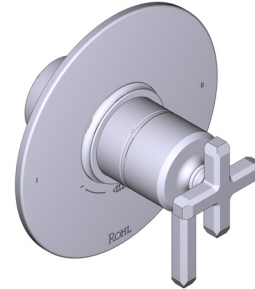

Garniture de soupape thermostatique à équilibrage de pression de 1/2 po, à 2 fonctions (distinctes) Apothecary^{MC}

MODÈLES : TAP44W1

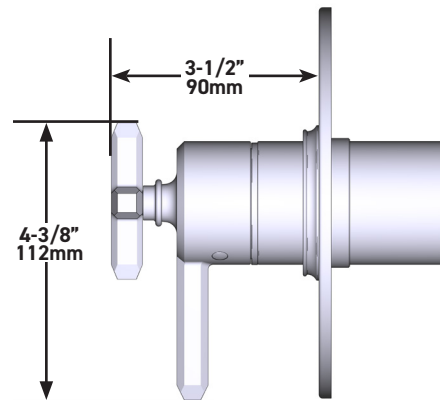
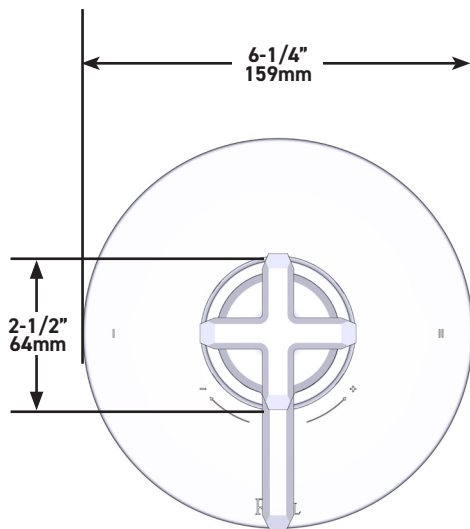

Pour la garantie ou des informations supplémentaires, contactez:

U.S.A.
houseofrohl.com/support
1-800-777-9762

QUÉBEC / MARITIMES / OUEST CANADIEN
houseofrohl.ca/support
1-866-473-8442

ONTARIO
houseofrohl.ca/support
1-800-287-5354

ESPECIFICACIONES

DESCRIPCIÓN

- Tecnología de válvula patentada con función termostática y de equilibrio de presión
- Control de temperatura y volumen
- 2 funciones exclusivas sin compartir entre las funciones
- La válvula empotrada se vende por separado
- Pida la válvula térmica y de equilibrio de presión R23 para completar la instalación
- El cartucho se envía con el juego de molduras 0915
- Cumple con las normas de la CEC
- Kits de extensión disponibles, EXT23KIT114 de 1 1/4" y EXT23KIT34 de 3/4"

CARTUCHO

- 0-915

ESTÁNDARES

- ASME A112.18.1

GARANTÍA

- La mayoría de los productos o piezas cuentan con "Garantías Limitadas" por defectos de fabricación. A los clientes en EE. UU. se les recomienda visitar houseofrohl.com/support y a los clientes en Canadá, houseofrohl.ca/support, para consultar las condiciones completas de la garantía de los productos y acabados.

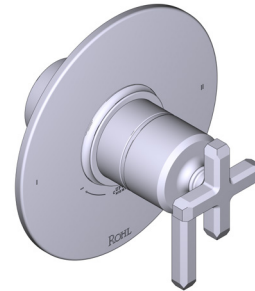

Moldura Apothecary™ de equilibrio térmico y de presión de 1/2" con 2 funciones (Sin compartir)

MODELOS: TAP44W1

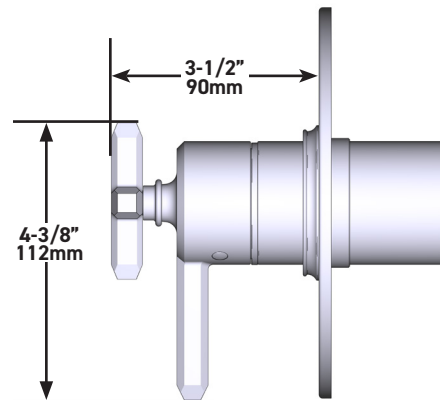
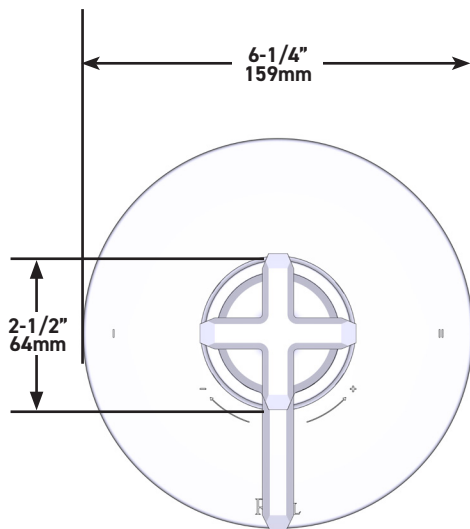

Para garantía o información adicional, comuníquese con:

U.S.A.
houseofrohl.com/support
1-800-777-9762

QUEBEC / MARITIMOS / CANADA OCCIDENTAL
houseofrohl.ca/support
1-866-473-8442

ONTARIO
houseofrohl.ca/support
1-800-287-5354