

## INSTALLATION INSTRUCTIONS

### CASSEROLE DISH STORAGE ORGANIZER

#### TOOLS REQUIRED:

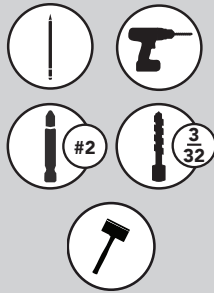

#### ESTIMATED ASSEMBLY TIME:

**25 MIN**

#### CARE AND MAINTENANCE:

Clean with a damp cloth and wipe parts dry.

#### WATCH TUTORIALS OF OUR PRODUCTS BEING INSTALLED



[WWW.REV-A-SHELF.COM/VIDEOS](http://WWW.REV-A-SHELF.COM/VIDEOS)



#### Parts List

No.	Description	Qty
A	Casserole Dish Storage	1
B	#6 X 1/2" Pan Head Screws	4
C	#6 X 1" Flat Head Screws	8
D	Slide Straps	2
E	Slide Strap Feet	4
F	Left & Right Slides	1 Set
G	Left & Right Slide Triggers	1 Set

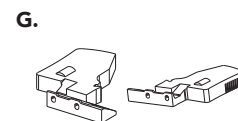
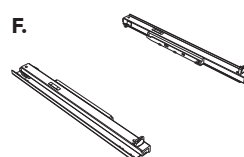
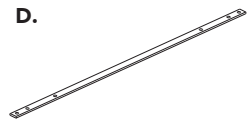
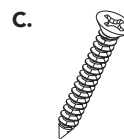
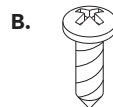
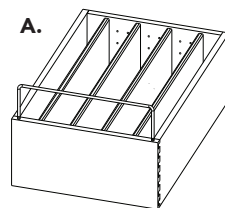

### STEP 1

To assemble the bottom mount slides, attach the slide strap feet to the slide straps (See Figure 1A).

Attach the left and right slides to the top of the feet. You will hear/feel a "snap" when connected completely (See Figure 1B).

Once slides are assembled, set them to the side (See Figure 1C).

FIGURE 1A

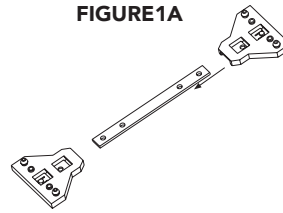

FIGURE 1B

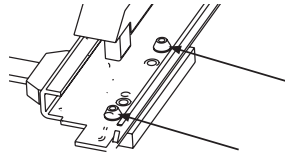
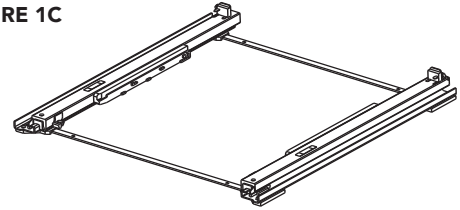

FIGURE 1C



### STEP 2

Find the left and right triggers and install the triggers on the correct side using (4) #6 X 1/2" pan head screws (See Figure 2A & 2B).

**Note:** Release triggers are side sensitive and are marked with an "L" & "R" for Left and Right.



FIGURE 2A

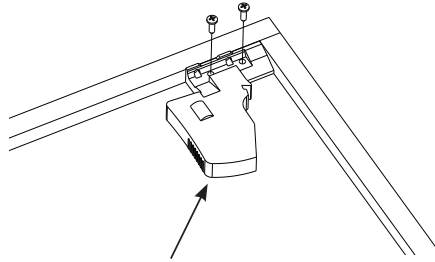
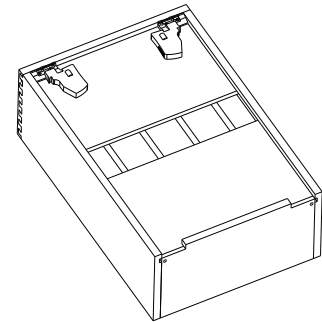

FIGURE 2B



### STEP 4

Take the handle and press it down in the required holes in the front of the dish storage unit. Use a rubber mallet to gently tap the handle firmly in place (See Figure 3).



FIGURE 3

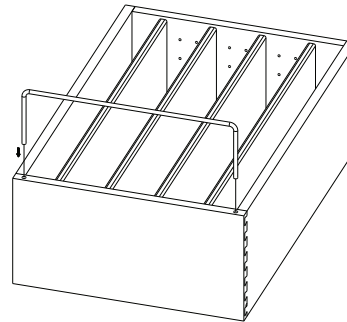

### STEP 5

Use instructions on the template to complete installation (See Figure 4).

FIGURE 4

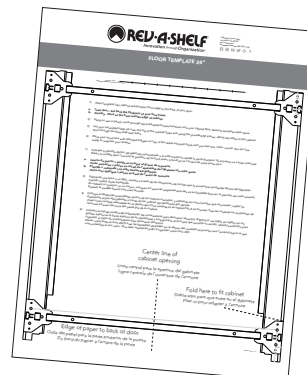

## INSTRUCCIONES DE INSTALACIÓN / LES INSTRUCTIONS D'INSTALLATION

### ALMACENAMIENTO DE PLATOS DE CAZUELA RANGEMENT POUR COCOTTES

Herramientas requeridas:  
Outils Requis:

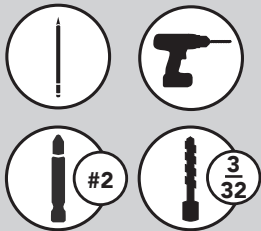

Tiempo estimado de ensamblado  
Durée de l'installation:

**25 MIN**

Cuidado/ Entretien:

Limpie con un paño húmedo y seque las partes.

Nettoyer avec un chiffon humide et essuyer pour sécher complètement.



#### Lista de partes / Liste des pièces

No.	Descripción / Description	Qty
A	<b>Almacenamiento de platos de cazuela</b> Rangement pour cocottes	1
B	<b>Tornillos de cabeza plana n° 6 X 1/2"</b> 6 vis à tête cylindrique de 1/2 po	4
C	<b>Tornillos de cabeza plana n° 6 X 1"</b> 6 vis à tête plate de 1 po	8
D	<b>Correderas de deslizamiento / Sangles coulissantes</b>	2
E	<b>Patas con Correa de Deslizamiento</b> Pied de sangle coulissante	4
F	<b>Correderas izquierda y derecha</b> Glissières gauches et droites	1 Establecer/Régler
G	<b>Gancho de correderas izquierda y Derecha</b> Gâchettes pour les glissières gauches et droites	1 Establecer/Régler

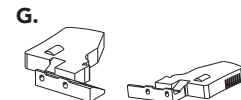
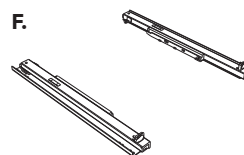
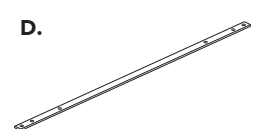
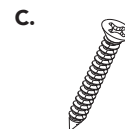
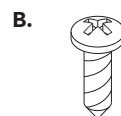
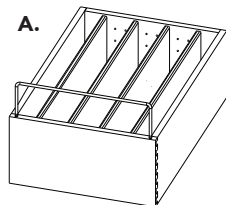

VER VIDEOS DE  
INSTALACIONES DE PRODUCTOS  
REGARDER DES VIDÉOS  
D'INSTALLATIONS DE PRODUITS



WWW.REV-A-SHELF.COM/VIDEOS

## PASO 1 / ÉTAPE 1

Para montar las correderas de montaje inferior, fije las patas de la correa de la corredera a las correas de la corredera (Vea la Figura 1A).

Conecte las correderas izquierda y derecha a la parte superior de las patas Escuchará/sentirá un "chasquido" cuando esté completamente conectado (Vea la Figura 1B).

Una vez que las correderas estén ensambladas, póngalas a un lado (Vea la Figura 1C).

*Pour assembler les glissières inférieures, fixez les pieds des sangles aux sangles coulissantes (voir la figure 1A).*

*Fixez les glissières gauche et droite sur le dessus des pieds. Vous entendrez/sentirez un claquement lorsque le tout sera complètement fixé (voir la figure 1B).*

*Une fois les glissières assemblées, placez-les sur le côté (voir la figure 1C).*

FIG.1A

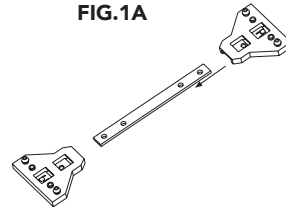

FIG. 1B

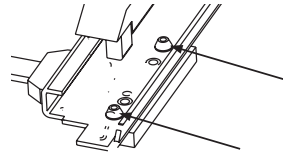
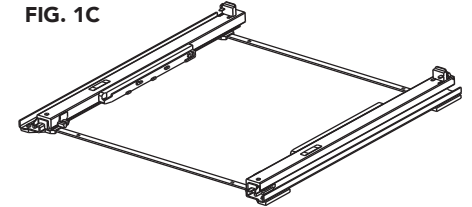

FIG. 1C



## PASO 2 / ÉTAPE 2

Busque los gatillos izquierdo y derecho e instale los gatillos en el lado correcto usando (4) tornillos de cabeza plana # 6 X 1/2" (Ver Figura 2A)

**Nota: los ganchos de liberación son sensibles de lado y están marcados con una "L" y una "R" para Izquierda y Derecha.**

*Trouvez les déclencheurs gauche et droit et installez les déclencheurs du bon côté à l'aide de (4) vis à tête cylindrique #6 X 1/2" (voir la figure 2A)*

*Remarque : Chaque gâchette est associée à un côté précis et elles sont marquées d'un « L » pour la gauche, et d'un « R » pour la droite.*

FIG. 2A

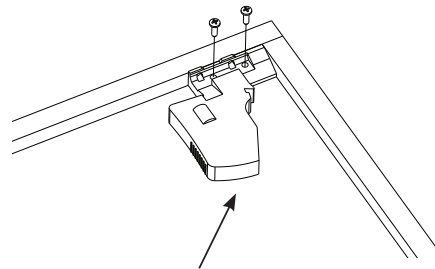
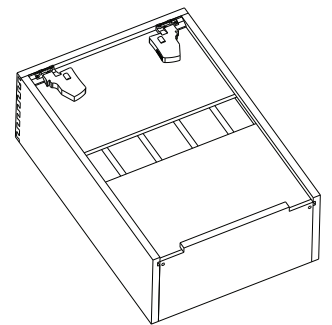

FIG. 2B



## PASO 3 / ÉTAPE 3

Tome el asa y presiónela hacia abajo en los orificios requeridos en la parte frontal de la unidad de almacenamiento de platos. Use un mazo de goma para golpear suavemente el mango firmemente en su lugar (Ver Figura 4).

*Prenez la poignée et enfoncez-la dans les trous requis à l'avant de l'unité de stockage de plaques. Utilisez un maillet en caoutchouc pour tapoter doucement la poignée fermement en place (voir la figure 4).*

FIG. 3

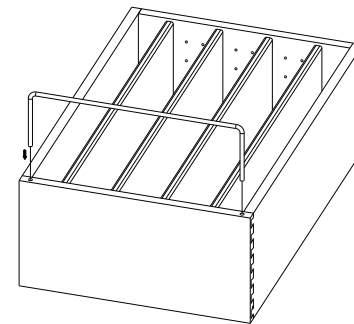
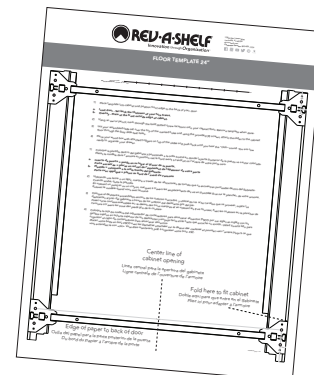

FIGURE 4



## PASO 4 / ÉTAPE 4

Utilice las instrucciones de la plantilla para completar la instalación (véase la figura 4).

*Utilisez les instructions d'utilisation sur le gabarit pour terminer l'installation (voir la figure 4).*