



Project:	Type:
Prepared By:	Date:

**Technical Specifications**

**Performance**

**Product Type:**

Compact

**Input Wattage:**

3.5W

**Lumens (Nominal):**

340lm

**Efficacy:**

97 lm/W

**L70 Lifespan:**

50,000-Hour LED lifespan based on IES LM-80 results and TM-21 calculations

**Wattage Equivalency:**

7W/9W G23

**LED Characteristics**

**Color Accuracy (CRI):**

80

**Color Temperature:**

3000K

**Electrical**

**THD:**

20%

**Power Factor:**

>0.9

**Dimmable:**

Non-Dim

**Input Voltage:**

120-277 Type B (Type A dependent on ballast)

**Operating Frequency:**

50/60Hz

**Operating Temperature:**

-20°C - 45°C (-4°F - 113°F)

**Technical Specifications (continued)**

**Construction**

**Bulb Shape:**

PLS-Horizontal

**Enclosure Material:**

Polycarbonate

**Housing Finish:**

White

**Lens Finish:**

Frosted

**Base Type:**

2-Pin G23

**Optical**

**Beam Angle:**

120°

**Installation**

**Installation Method:**

UL Type A with Magnetic Ballasts & UL Type B (Dual Mode)

**Burning Position:**

Horizontal

**Other**

**Technology EQ:**

CFL

**Warranty:**

RAB warrants that our LED products will be free from defects in materials and workmanship for a period of five (5) years from the date of delivery to the end user, including coverage of light output, color stability, driver performance and fixture finish. RAB's warranty is subject to all terms and conditions found at [rablighting.com/warranty](http://rablighting.com/warranty).

**Buy American Act Compliance:**

RAB values USA manufacturing! Upon request, RAB may be able to manufacture this product to be compliant with the Buy American Act (BAA). Please contact customer service to request a quote for the product to be made BAA compliant.

**Compliance**

**Safety Listing:**

UL Listed, UL Classified

**Environment/Fixture Rating:**

Damp / Enclosed

**RoHS:**

Mercury and UV free. RoHS-compliant components.

**FCC:**

Complies with Part 15 of the FCC Rules

**Model Number:**

T10203(PLS-3.5-H-830-HYB)

**Minimum Compartment Size**

Length x Width x Height [in]	Lamp Quantity
5.6 x 5.7 x 3.2	1

**Case and Pallet Dimensions**

	QTY	LENGTH (in)	WIDTH (in)	HEIGHT (in)
CASE	12	0	0	0
PALLET	1392	0	0	0

**Dimension**

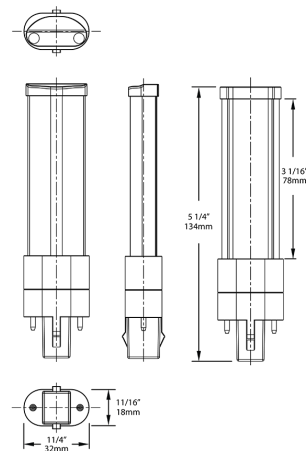

**Light Distribution**

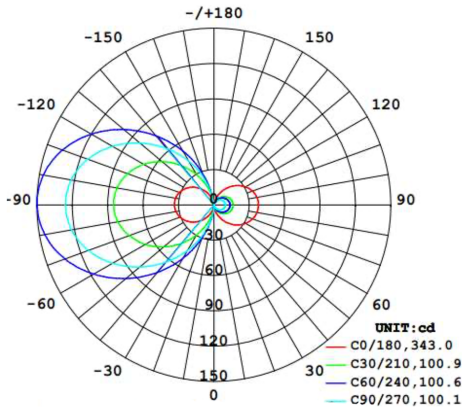

**Features**

- Replaces 13W CFL Lamps
- Plug and Play on existing magnetic CFL ballasts or can be wired directly to line voltage without need for an external driver or ballast
- Compatible with Gx23 base installations
- 50,000 hour Lifespan
- Environmentally friendly, no mercury used
- UL Classified
- Rated for use in enclosed and open fixtures in dry or damp locations
- 5 Year No Compromise Warranty

**Ordering Matrix**

Family	Wattage	Orientation	CRI/Color Temp	Installation Type
PLS	3.5	H	830	HYB
	3.5 = 3.5W 5 = 5W 5.2 = 5.2W	H = Horizontal	840 = 80 CRI, 4000K 835 = 80 CRI, 3500K 830 = 80 CRI, 3000K 827 = 80 CRI, 2700K	HYB = Hybrid