

INSTRUCTIONS

LED T8 tube series- Single or Double-Ended Bypass T8



RAB Lighting is committed to creating high-quality, affordable, well-designed and energy-efficient LED lighting and controls that make it easy for electricians to install and end users to save energy. We'd love to hear your comments. Please call the Marketing Department at 888-RAB-1000 or email: marketing@rablighting.com

T8-18.5-48G-8XX-SD-BYP
T8-9.5-48G-8XX-SD-BYP



IMPORTANT

READ CAREFULLY BEFORE INSTALLING LED TUBE. RETAIN THESE INSTRUCTIONS FOR FUTURE REFERENCE.

RAB LED tubes must be wired in accordance with the National Electrical Code and all applicable local codes. Proper grounding is required for safety. THIS PRODUCT MUST BE INSTALLED IN ACCORDANCE WITH THE APPLICABLE INSTALLATION CODE BY A PERSON FAMILIAR WITH THE CONSTRUCTION AND OPERATION OF THE PRODUCT AND THE HAZARDS INVOLVED.

WARNINGS:

SUITABLE FOR DAMP LOCATIONS. DO NOT USE WITH DIMMERS.

THIS DEVICE IS NOT INTENDED FOR USE WITH EMERGENCY EXITS. NOT FOR USE WITH LIGHT DIMMERS.

THE RETROFIT KIT IS ACCEPTED AS A COMPONENT OF A LUMINAIRE WHERE THE SUITABILITY OF THE COMBINATION SHALL BE DETERMINED BY AUTHORITIES HAVING JURISDICTION. PRODUCT MUST BE INSTALLED BY A QUALIFIED ELECTRICIAN IN ACCORDANCE WITH THE APPLICABLE AND APPROPRIATE ELECTRICAL CODES. THE INSTALLATION GUIDE DOES NOT SUPERSEDE LOCAL OR NATIONAL REGULATIONS FOR ELECTRICAL INSTALLATIONS.

THIS DEVICE COMPLIES WITH PART 15 OF THE FCC RULES. OPERATION IS SUBJECT TO THE FOLLOWING TWO CONDITIONS: (1) THIS DEVICE MAY NOT CAUSE HARMFUL INTERFERENCE, AND (2) THIS DEVICE MUST ACCEPT ANY INTERFERENCE RECEIVED, INCLUDING INTERFERENCE THAT MAY CAUSE UNDESIRABLE OPERATION.

RISK OF SHOCK-DISCONNECT POWER BEFORE INSTALLATION.

RISK OF FIRE OR ELECTRIC SHOCK. LED RETROFIT KIT INSTALLATION REQUIRES KNOWLEDGE OF LUMINAIRE ELECTRICAL SYSTEMS. IF NOT QUALIFIED, DO NOT ATTEMPT INSTALLATION AND CONTACT A QUALIFIED ELECTRICIAN.

RISK OF FIRE OR ELECTRIC SHOCK. PRODUCT MUST BE INSTALLED IN ACCORDANCE WITH THE NATIONAL ELECTRICAL CODE OR YOUR LOCAL ELECTRICAL CODE. IF YOU ARE NOT FAMILIAR WITH THESE CODES AND REQUIREMENTS, CONTACT A QUALIFIED ELECTRICIAN.

RISK OF FIRE OR ELECTRIC SHOCK. INSTALL THIS KIT ONLY IN THE LUMINAIRE THAT HAVE THE CONSTRUCTION FEATURES AND DIMENSIONS SHOWN IN THE PHOTOGRAPHS AND/OR DRAWINGS AND WHERE THE INPUT RATING OF THE RETROFIT KIT DOES NOT EXCEED THE INPUT RATING OF THE LUMINAIRE.

TO PREVENT WIRING DAMAGE OR ABRASION, DO NOT EXPOSE WIRING TO EDGES OF SHEET METAL OR OTHER SHARP OBJECTS. DO NOT MAKE OR ALTER ANY OPEN HOLES IN AN ENCLOSURE OF WIRING OR ELECTRICAL COMPONENTS DURING KIT INSTALLATION.

TO AVOID POTENTIAL FIRE OR SHOCK HAZARD, DO NOT USE THIS RETROFIT KIT IN LUMINAIRE EMPLOYING SHUNTED BI-PIN LAMP HOLDERS. NOTE: SHUNTED LAMP HOLDERS ARE FOUND ONLY IN FLUORESCENT LUMINAIRE WITH INSTANT-START BALLASTS. INSTANT-START BALLASTS CAN BE IDENTIFIED BY THE WORDS "INSTANT START" OR "I.S." MARKED ON THE BALLAST. THIS DESIGNATION MAY BE IN THE FORM OF A STATEMENT PERTAINING TO THE BALLAST ITSELF, OR MAY BE COMBINED WITH THE MARKING FOR THE LAMPS WITH WHICH THE BALLAST IS INTENDED TO BE USED, FOR EXAMPLE F40T12/IS. FOR MORE INFORMATION, CONTACT THE LED LUMINAIRE RETROFIT KIT MANUFACTURER.

INSTALLERS SHOULD NOT DISCONNECT EXISTING WIRES FROM LAMP HOLDER TERMINALS TO MAKE NEW CONNECTIONS AT LAMP HOLDER TERMINALS. INSTEAD INSTALLERS SHOULD CUT EXISTING LAMP HOLDER LEADS AWAY FROM THE LAMP HOLDER AND MAKE NEW ELECTRICAL CONNECTIONS TO LAMP HOLDER LEAD WIRES BY EMPLOYING APPLICABLE CONNECTORS.

INSTRUCTIONS



LED T8 tube series- Single or Double-Ended Bypass T8

RAB Lighting is committed to creating high-quality, affordable, well-designed and energy-efficient LED lighting and controls that make it easy for electricians to install and end users to save energy. We'd love to hear your comments. Please call the Marketing Department at 888-RAB-1000 or email: marketing@rablighting.com

SINGLE-ENDED INSTALLATION

- 1) Make sure the circuit breaker that supplies the power to the fixture is turned off.
- 2) Remove lens or diffuser cover(if applicable) and existing fluorescent lamps.
- 3) Open/Remove ballast wiring compartment cover.
- 4) Identify the line and neutral wires running from the breaker box to the ballast and confirm the power is off using a voltmeter.
- 5) Cut all wires connected to ballast, and remove ballast (and starter if present). Dispose of removed ballast and fluorescent lamps in accordance with government regulations in your area.
- 6) Ensure that the fixture contains non-shunted G13 bi-pin lampholders(Fig. 1).If socket lampholder are internally shunted,then replace with new non-shunted socket lampholders.If socket lampholders are shunted with a jumper wire,remove wire to convert into non-shunted sockets.

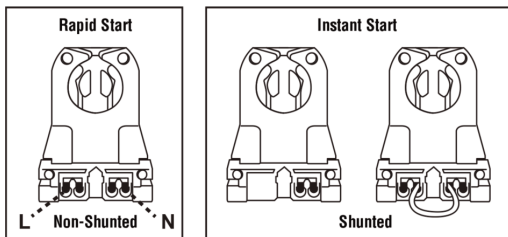

Fig:1 - Non-shunted & Shunted Lamp Holder

- 7) RAB LED T8 lamps are designed for single sided connections (Fig. 2).To install,please wire non-shunted sockets by connecting one wire from the lampholder to branch circuit L(LIVE) and other wire at the opposite end to the branch circuit N(NEUTRAL). Do not connect opposite side to power.Use appropriate wires for connection.



Fig:2 - Single sided connection

SINGLE-ENDED INSTALLATION (cont'd)

- 8) Make sure all sockets are replaced and wired according to the appropriate wiring diagram(Fig. 3-6)..

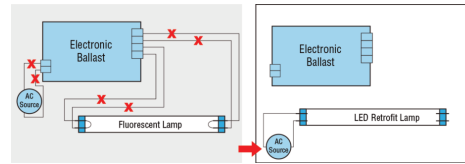

Fig:3 - Retrofit with One Lamp

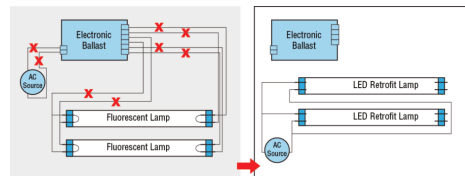

Fig:4 - Retrofit with Two Lamps

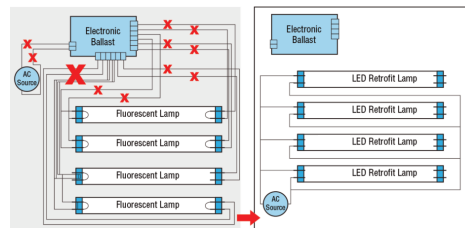

Fig:5 - Retrofit with Three/Four Lamps

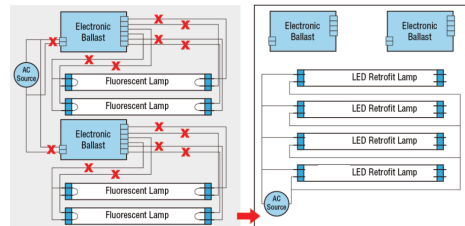

Fig:6 - Retrofit with Three/Four Lamps & Two Ballasts

- 9) Reinstall the ballast cover to hide all wires.
- 10) Install RAB new LED T8 replacement lamps.
- 11) Apply warning label on a visible location inside the fixture.
- 12) Reinstall lens or diffusion cover on the light fixture.
- 13) Turn power on at the breaker box.
- 14) Turn on the lights.

Note: These instructions do not cover all details or variations in equipment nor do they provide for every possible situation during installation, operation or maintenance.

INSTRUCTIONS



LED T8 tube series- Single or Double-Ended Bypass T8

RAB Lighting is committed to creating high-quality, affordable, well-designed and energy-efficient LED lighting and controls that make it easy for electricians to install and end users to save energy. We'd love to hear your comments. Please call the Marketing Department at 888-RAB-1000 or email: marketing@rablighting.com

DOUBLE-ENDED INSTALLATION

- 1) Make sure the circuit breaker that supplies the power to the fixture is turned off.
- 2) Remove lens or diffuser cover(if applicable) and existing fluorescent lamps.
- 3) Open/Remove ballast wiring compartment cover.
- 4) Identify the line and neutral wires running from the breaker box to the ballast and confirm the power is off using a voltmeter.
- 5) Cut all wires connected to ballast, and remove ballast (and starter if present). Dispose of removed ballast and fluorescent lamps in accordance with government regulations in your area.
- 6) RAB LED T8 lamps are designed for double-ended connections(Fig. 1).

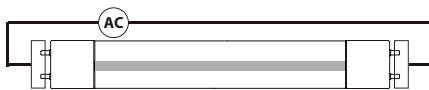

Fig:1 - Double-Ended connection

- 7) Wire using appropriate wiring diagram(Fig. 2-4).

DOUBLE-ENDED INSTALLATION (cont'd)

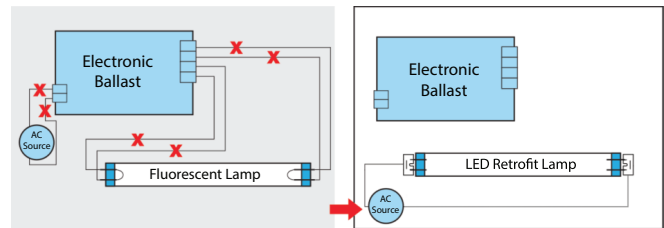

Fig:2 - Retrofit with One Lamp

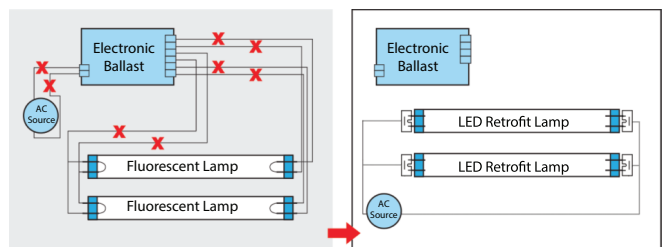

Fig:3 - Retrofit with Two Lamps

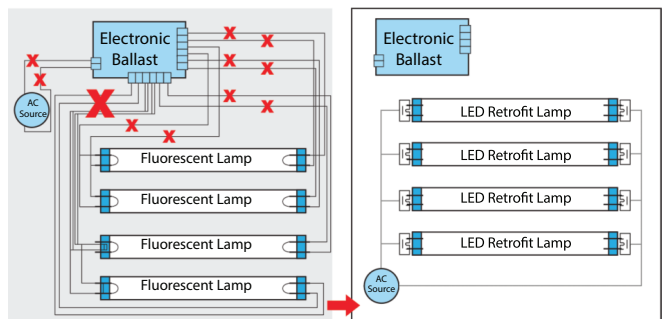

Fig:4 - Retrofit with Three/Four Lamps