

acquabella®

Installation and Operation Manual

Effective May 1, 2024



Mineral Composite Tubs
Freestanding Soaker and Airbath Systems

Installer: This booklet must be given to the product owner.
Please include important information below:

Distributor Name
Model Number
Manufacturer's Date
Serial / Registration Number

Owner's Manual & Installation Guide

Thank you for purchasing an Acquabella product.

The instructions in this booklet will provide you with the information needed to install and maintain this unit. The ease of cleaning and the elegant look will provide you with many years of pleasure. This information is also available on acquabellabaths.com.

Our customer service department is available to answer any additional questions you may have pertaining to installation and care of your Acquabella product. Please call **800-783-8827** to speak to our Service Department or email service@acquabellabaths.com.



Table of Contents

Important Safety Instructions	4
Installation Instructions	5-10
Tubs	6
Air Bath	8
Air Bath Operating Instructions	
Keypad and Remote Control.....	11
Care and Cleaning Instructions	12
Troubleshooting.....	13
Residential Warranty.....	14-15
Commercial Warranty.....	16-17

Important Safety Instructions

This manual contains information and instructions for proper operation and maintenance of the bathtub. Failure to follow these instructions could result in personal injury, electrical shock or fire.



INSTRUCTIONS PERTAINING TO RISK OF FIRE, ELECTRIC SHOCK, OR INJURY TO PERSONS.

WARNING: When using electrical products, basic precautions should be followed including the following:

- Do not permit children to use this unit unless they are closely supervised by an adult at all times. Supervision is also required when bath is used by an elderly or handicapped individual.
- Never leave a full or filling bath unattended.
- Use this unit only for its intended use as described in this manual. Do not use attachments not recommended by the Manufacturer. Never drop or insert any object into any opening.
- The water in a bath should never exceed 40° C (104° F). Water temperatures between 38° C (100° F) and 40° C (104° F) are considered safe for a healthy adult. Use time should be limited to approximately 10 minutes, followed by a shower to cool down. Longer exposures may result in hyperthermia, which can be fatal. The symptoms of this condition are nausea, dizziness and fainting. Lower water temperatures are recommended for extended use (exceeding 10 - 15 minutes) and for young children.
- Since excessive water temperatures have a high potential for causing fetal damage during the early months of pregnancy, pregnant or possibly pregnant women should limit water temperatures to 38° C (100° F).
- The use of drugs or alcoholic beverages before or during bathing may lead to unconsciousness with the possibility of drowning. Never use the bath while under the influence of alcohol, anticoagulants, stimulants, antihistamines, vasoconstrictors, vasodilators, hypnotics, narcotics or tranquilizers.
- Persons using medication should consult a physician before using a bath since medication may induce drowsiness while other medications may affect heart rate, blood pressure and circulation.

CAUTION: Do not use harsh abrasives or solvents for cleaning this unit.

DANGER: To reduce the risk of injury, enter and exit the bath slowly.

WARNING: Never operate electrically connected devices in or within 5' of the bath. Never drop or insert any object into any opening within the bath.

DANGER: Risk of electric shock. Connect only to circuits protected by a Ground Fault Circuit Interrupter (GFCI). Such a device should be installed by a licensed electrician and should be tested on a regular basis (at least monthly). To test the GFCI push the TEST button. The GFCI should interrupt the power. Push the RESET button and the power should be restored. If the GFCI fails to operate in this manner there is the possibility of an electric shock. DO NOT USE. Disconnect the unit and have the problem corrected by a qualified service technician. To avoid the possibility of personal injury and discoloration of the surface material, the inlet water temperature should not exceed 60° C (140° F).

DANGER: Disconnect power before servicing.

INSTALLER/OWNER BEARS ALL RESPONSIBILITY TO COMPLY WITH ALL STATE AND LOCAL CODES WHEN INSTALLING THIS PRODUCT.

SAVE THESE INSTRUCTIONS

Installation Instructions

Read all instructions before installing tub. The Manufacturer recommends using a professional installer for this product. Installer/product owner is responsible for complying with all state and local codes. Handle this tub with extreme caution. Dropping this product, even from several inches, may cause cracking and permanent damage. Rubber gripped gloves may make it easier to handle the mineral composite bath.

WARNING: Certain cleaning products will permanently damage the mineral composite surface. Read product label carefully before using any cleaning product. Never use anything abrasive, aerosol sprays or any product that is described as “scrubbing bubbles.” Please see ‘**Care & Cleaning Instructions**’ on pg. 12.

Before Installing

- Inspect tub thoroughly.
- Damage from shipping or delivery must be reported to carrier immediately. **Do not install damaged tub. The Manufacturer is not responsible for damage occurring during transit.**
- Factory defect must be reported to factory before tub is installed. Defects or damage claimed after installation will be excluded from warranty.
- Measure tub on site carefully. Specifications are subject to change without notice. The Manufacturer is not responsible for any preparatory labor or materials.

Please note: Blemishes, air holes or casting marks on the underside of the bath are not considered defects and do not affect the performance or quality of the bath.

Always protect the tub from construction damage by using a protective cover. Damage, including chips and scratches incurred at the jobsite are excluded from warranty, but may be repaired by a qualified technician at the owner’s expense. Do not stand in the tub or store materials in the tub during construction. Tubs are intended for indoor use. Tubs are warranted for indoor installation in a climate controlled environment only.

Never leave a full or filling bath unattended.

Warranty Cards & CERTIFICATION Labels

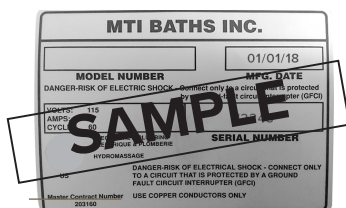

IMPORTANT: Locate and note the serial number on the cover of this manual for any future service needs.

Drain Rough-In Dimensions for Freestanding Tubs with Integral Overflow

Mineral composite freestanding tubs may be installed with the overflow positioned in the rear or the front of the tub, however, rough-in dimensions provided below are from center of drain to the top outside edge as shown on the product specification sheet. See product specs for line drawing of each tub model.

Model No.	Measurement X
400	16"
401	15½"
402	8¼"
403	15½"
404	16"
405	9"
406	8"
407	16⅓"
408	16"

Model No.	Measurement X
409	19½"
410	16¼"
411	16¾"
412	16½"
414	10½"
416	12"
417	12"
418	18½"
419	13½"

Model No.	Measurement X
420	16¼"
421	16½"
422	15½"
423	15
550	15½"
552	8¾"
553	12"

The toe tap drain kit for these tub models includes a straight PVC fitting for weld adhesive connection to the drain pipe directly underneath the tub drain. A 6" brass tailpiece is available, sold separately. When installing to brass, use the provided brass nut in lieu of the PVC fitting to secure the assembly to the threaded drain body.¹

Distance from the bottom of the drain to the finished floor will vary with each tub model. Adjust leveling feet to ensure tub is level. Before trimming rough-in pipe, measure the distance from the bottom of the tub to finished floor. Weight of the tub should not rest on the drain; damage may result.¹

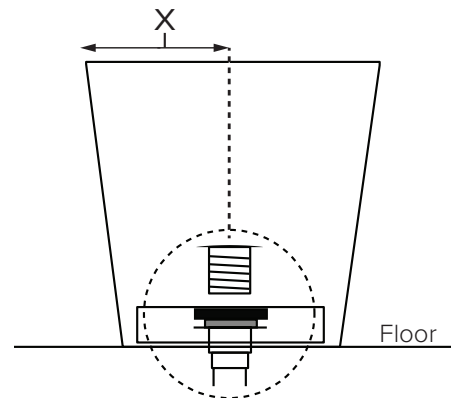

¹ The Manufacturer does not warrant leaks or damages associated with improper drain installation and will not be responsible for any costs related to improper installation. If you need assistance, please call the Acquabella Service Department at 800.783.8827.

Installation Instructions – Tubs with Integral Overflow

The integral overflow tubs by Acquabella require only the waste to be installed. The P-trap will be located directly below the drain (see tub specification sheet). The tub comes equipped with a toe tap drain and PVC drain fitting.

⚠ **The Manufacturer recommends using clear 100% silicone sealant. Do Not use plumber's putty.**

With Access From Ceiling Below

1. Install drain on tub using clear silicone under waste flange and both sides of the rubber gasket. Use a small amount of clear silicone on the threads of the PVC drain fitting to act as a thread sealant. Tighten until it seats, plus one half turn.

⚠ **Do not overtighten and do not exceed 7 ft-lbs maximum. Product damage will occur.**

2. Adhere tub to a level, finished floor using ½-inch bead of clear silicone¹. Align tub drain with box-out in floor.²

3. Finish drain installation from below. Use PVC cement to connect PVC drain fitting to P-trap.

4. Allow time for silicone to cure and water test for leaks. Refer to product label for details.

Without Access From Below

1. Stub out drain and P-trap with 1 ½ schedule 40 PVC pipe at least 1" above finished floor. Because the height will vary slightly from tub to tub, box out around the pipe to allow trimming this pipe below grade upon installing the supplied fitting. The fitting is approximately 3" in diameter.

2. Determine gap between underside of tub (at drain) and the floor. Shorten 1 ½ inch pipe to allow for the PVC fitting and gasket above the finished floor. Glue fitting to pipe with PVC cement; remember to allow for the thickness of the rubber gasket. Make sure that the top of the flange is level.

3. Secure rubber gasket to top of fitting with clear silicone. Apply bead of silicone on top of gasket. Use silicone on the threads of PVC drain fitting to act as a thread sealant.

4. Adhere tub to a level, finished floor using ½-inch bead of clear silicone¹. Align tub drain with rough-in.²

5. Place a small bead of silicone under waste flange; thread into PVC drain fitting. Tighten until it seats, plus 1-quarter turn.

⚠ **Do not overtighten and do not exceed 7 ft-lbs maximum. Product damage will occur.**

6. Allow time for silicone to cure and water test for leaks. Refer to product label for details.

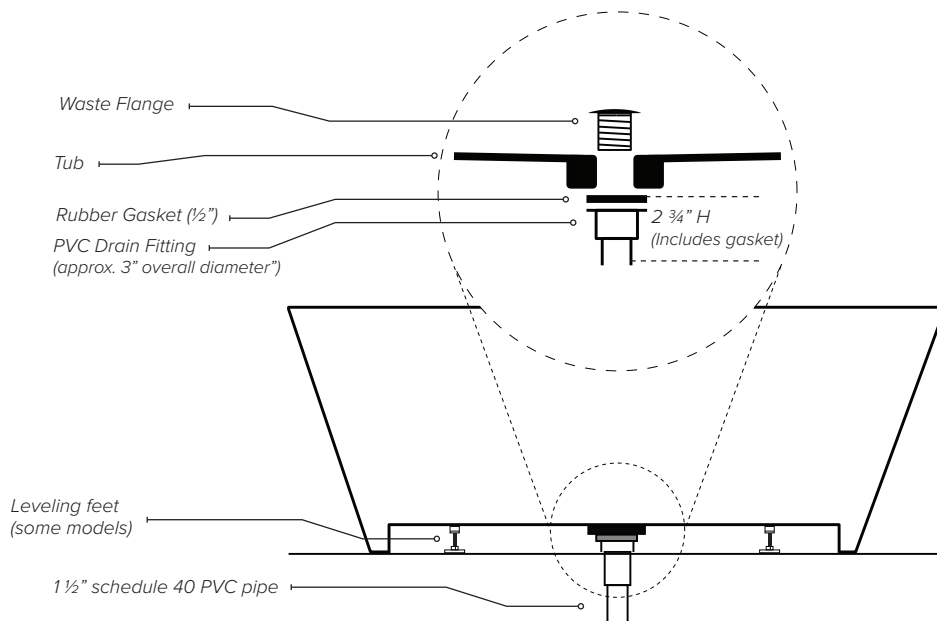

¹ Tub must be level in order to drain properly. Do not adhere tub to a floor that is not level. Some models come equipped with leveling feet to adjust for a finished floor that is not level. Fill any gaps with color-matched caulk.

² The Manufacturer does not warrant leaks or damages associated with improper drain installation and will not be responsible for any costs related to improper installation. If you need assistance, please call the Acquabella Service Department at 800.783.8827.

Installation Instructions – Airbath

To maintain optimal performance and easy operation, the following conditions must be met.

Electrical installation instructions

See Important Safety Information on pg. 4 of this manual and Electrical Specifications below. This circuit must be connected to a supply that is protected by a ground fault circuit interrupter (GFCI). Such a GFCI should be provided by the installer and accessible for testing on a routine basis.

Testing The GFCI:

Push the **TEST** button. The GFCI should interrupt power.
Push the **RESET** button. Power should be restored.

WARNING: If the GFCI fails to operate in this manner, there is a ground current flowing, indicating the possibility of electric shock. DO NOT use this unit. Disconnect the unit and have the problem corrected by a qualified service representative before using.

Every Acquabella air blower is supplied with a 29” grounded cord and NEMA plug to be plugged into a grounded receptacle*. **Do not remove this plug.** If a wall mount switch is desired to control use of the unit, the switch should control the receptacle. **Under no circumstance should you alter the provided supply cord.**

Before servicing unit, shut off all electrical outlets as more than one outlet may be energized.

*Air blowers do not require a bonding conductor.

Electrical Specifications

Air Blower.....9.5 AMP

System components supplied with Acquabella tubs intended for installation within the U.S. & Canada are limited to 110V. Check the order details when installing outside of these territories.

Airbath Installation Instructions

Read all installation instructions before beginning install.

The blower and check valve must be remotely located within 8’ of the tub (**Fig. 1, pg. 10**). A common location is a closet or cabinet. The check valve must be 2” above the height of the top of the tub rim and can be mounted to the framing or wall with pipe hanger, pipe clamp, metal straps or wire ties. Acquabella airbaths come with a remote control and optional keypad.

Blower Installation

- Installation location of the blower must be properly ventilated to keep it from overheating and climate controlled to avoid the impact of cold ambient air on the performance of the blower and guard against humidity that can be corrosive to the electronics.
- 14” x 16” access must be provided for future servicing.
- The blower requires approximately 2ft³ of space and 1” x 4” vent for proper circulation. Do not use insulation within 8” of the blower, and never wrap insulation around the blower as this will cause the equipment to fail.
- Secure blower using wood screws through the mounting feet.
- Within 2 ft. of the blower, there must be a GFCI electrical outlet on a 110 VAC that is the recommended size for the air system. The GFCI outlet must be accessible for future servicing.

Note: The Manufacturer does not recommend locating the blower more than 8’ from the tub to prevent heat loss from the blower to the tub. 1” schedule 40 PVC pipe and pipe insulation may be used to help retain the warmth of air from the blower.

Installation Instructions – Airbath

To maintain optimal performance and easy operation, the following conditions must be met.

Check Valve And Airline Installation

- The remote check valve **MUST** be mounted at least 2" above the top rim of the tub. Use 1" PVC flexible pipe or rigid schedule 40 to connect the remote check valve to the manifold (factory installed underneath the tub) or to the gray air hose at the manifold. Connect the check valve to the blower using the gray hose. Make sure ring clamps are secure on both end of the gray hose(s).
- **NOTE:** Depending on remote check valve location and site conditions, the air hose that is attached to the manifold can remain within the pedestal or run under the floor to connect to the roughed in airline in the floor, or exit the tub through the side of the pedestal base for an above-the-floor airline installation. When running gray hose under the floor, use a heat resistant adhesive to secure connection from hose to pipe and use care not to crush or restrict the airflow in the line in any way.

IMPORTANT: Side exit from the pedesal would require onsite drilling through the pedestal and should only be considered when there is no subfloor access to run the airline. The Manufacturer does not recommend an above-the-floor airline, unless the tub and outlet in pedestal are very close the wall or the airline can be concealed with nearby or surrounding cabinetry. Onsite modification to the pedestal is performed at the risk of the installer. The Manufacturer does not pre-drill the pedestal base for side exit (**Photo A**).

Water Sensor, Remote Control & Keypad Installation

- The water sensor wire, factory installed to posts under the tub on either side of the tub drain (**Photo B**), will connect to a port on the side of the blower (**Fig. 2, pg. 10**). Do not attempt to remove the sensor wires from the tub. To extend this wire, splice in 18 gauge, low voltage wire. Be sure to save the two pin connector to allow connection to the blower.
- Use the 12" ethernet cable to connect the radio frequency (RF) receiver module to the blower (**Fig. 2, pg. 10**). The keypad comes synchronized to the blower from the factory. Synchronization instructions are provided with the remote control.
- The keypad is optional and can be mounted convenient to the bather or in an inconspicuous location to use as a secondary option for system control. Use the 6' ethernet cable to connect keypad to secondary jack on radio receiver module (**Fig. 2, pg. 10**).

Test

- Plug the blower into the outlet and test for operation. After the airbath is turned off and water drains from the tub, the LED light on the keypad will flash continuously, indicating the purge cycle is activated.
- **NOTE:** All air baths are equipped with an automatic drying cycle. Approximately 7 minutes after the bath is drained, the blower will turn on for 1-2 minutes. This drying cycle cannot be cancelled. Any attempt to cancel this cycle resets the countdown timer. When the purge cycle is complete, the LED light will cease flashing.

Photo A

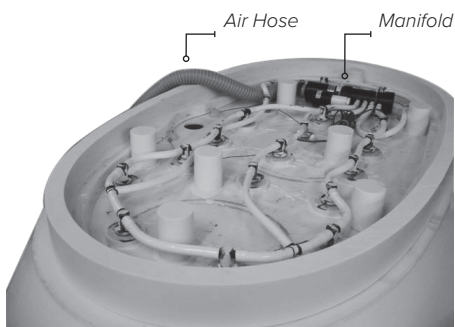
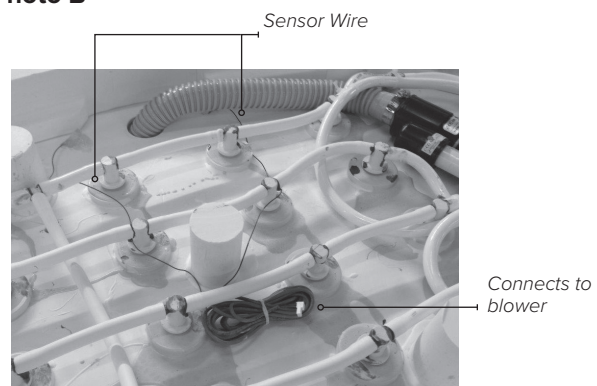

Photo B



Airbath Installation (continued)

Remote Installation Of Air Blower

The following illustration is referenced in the instructions on pg. 8.

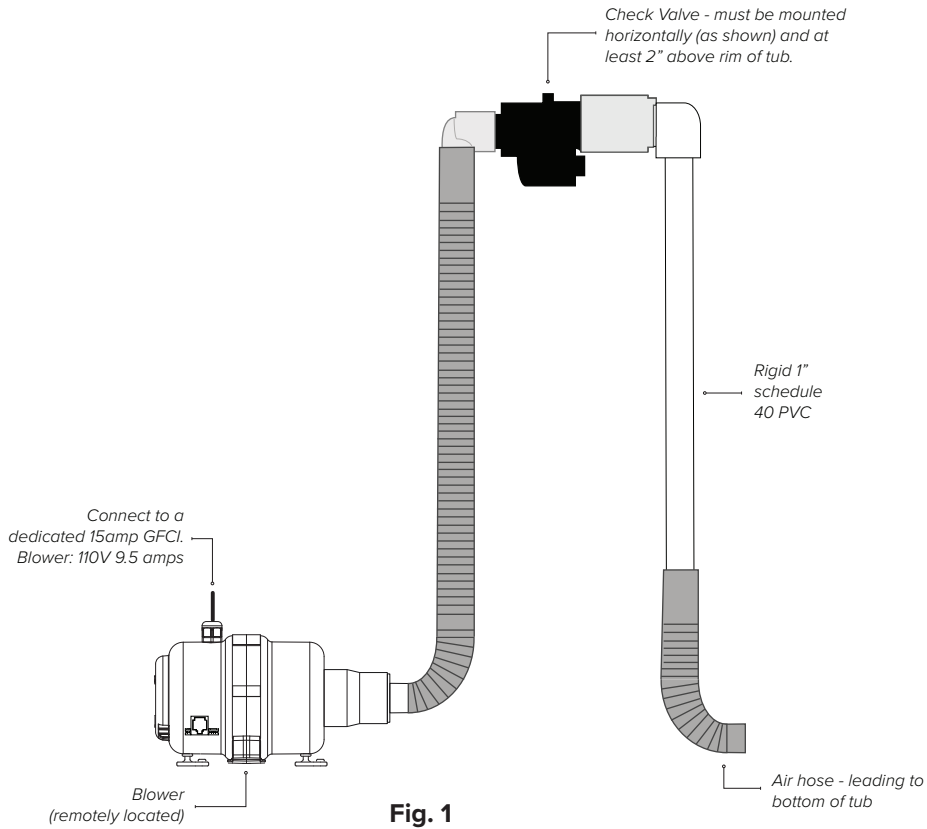

Remote Installation Of Air System Components

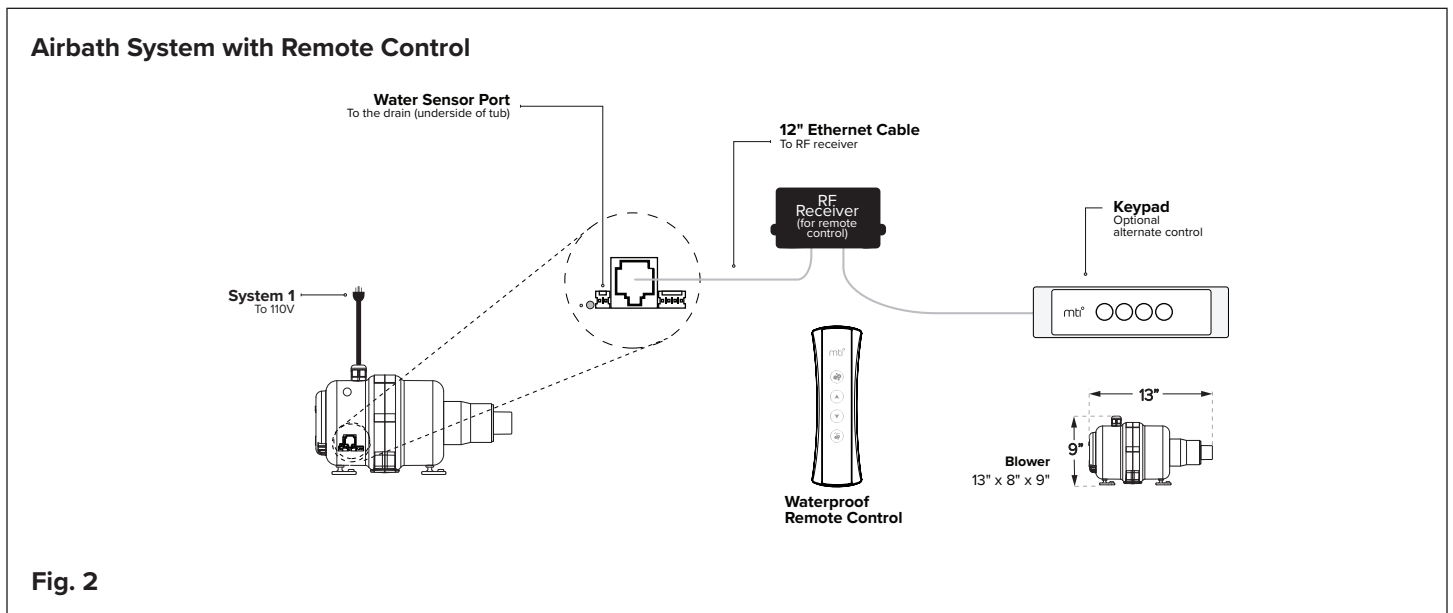

IMPORTANT! Never under any circumstances modify the power cords.

Operation Instructions

Airbath

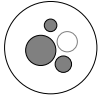
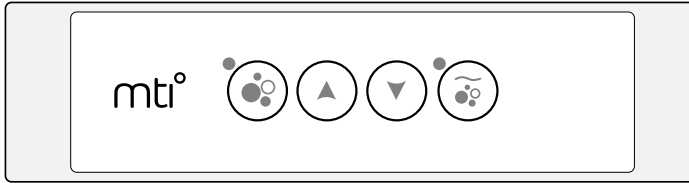

AIRBATH

1st Press: The blower starts. LED indicator light on.
2nd Press: The blower stops. LED indicator light off.
NOTE: Blower automatically stops after 20 minutes.

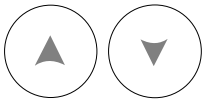

THERAPY CONTROL

Use arrow buttons to gradually adjust airbath intensity.



AIR MASSAGE MODE

1st Press (Wave): Speed varies gradually from maximum to minimum. LED indicator light is on.
2nd Press (Pulse): Speed alternates quickly between minimum and maximum. LED indicator light will flash.
3rd Press (Max): Returns to maximum speed. LED indicator light off.

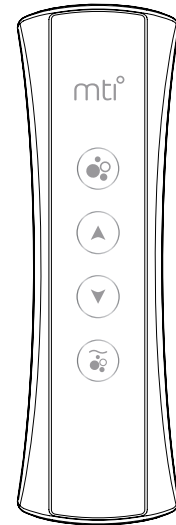

Airbath Remote Control



Automatic Purge / Drying Cycle

Acquabella airbaths are equipped with an automatic drying cycle designed to purge residual water from air jets installed on the floor of the bath. Drying cycle is programmed to come on 7 minutes after the airbath is turned off and any time water is introduced, then drained from the tub. Water sensors on either side of the tub drain prevent activation of the drying cycle, until water is drained from bath. The sensors will activate the purge/drying cycle upon bathing or cleaning the bathtub.

- The purge cycle starts approximately 7 minutes after the bath is drained and runs for 1 minute.
- To delay the automatic purge for another 7 minutes, once it begins, press . Press again to completely cancel the automatic purge. The Manufacturer does not recommend canceling the purge regularly, as the drying cycle is designed to help maintain optimal performance of the airbath.

Alternate 24-hour purge cycle programming overrides default settings, allowing the purge cycle to run once every 24 hours at the time the cycle is first programmed.

To program 24-hour purge cycle:

- Hold  on the keypad for 5 seconds. The indicator light next to the airbath button  flashes once when programmed successfully.
- Press and hold  again for 5 seconds to restore the default setting. The indicator light flashes twice when default setting is restored.

Water sensors will delay daily purge, if there is water in the tub at the time purge cycle is programmed to start. 7 minutes after water has drained, the drying cycle starts.

Manual Stop

Press airbath button  during the 1-minute drying cycle, to stop the cycle. Purge/Drying cycle will restart 24 hours later at the programmed time.

In the event of a power disruption or brown out, the purge/drying cycle will return to default setting. Manually reprogram as needed.

Care and Cleaning Instructions

About the Mineral Composite Shell

Mineral composite has a stain-resistant, non-porous surface. With normal use, this surface will retain its appearance with a minimal amount of care.

When Cleaning

- Remove dust and dry dirt with a soft, damp cloth.
- Apply common household, non-abrasive cleaner in accordance with Manufacturer's directions and precautions. (i.e., a mild dishwashing detergent such as Ivory Liquid). Do not use unless the product label specifically states that it is safe for acrylic or plastic.
- Rinse well and dry with a soft, clean cloth. Scouring pads will deteriorate the finish.
- Never use any type of "scrubbing bubbles" or aerosol spray cleaners on the mineral composite product.
- Never use bleach, ammonia or organic solvents, such as lacquer, alcohol, acids or alkalis to come into contact with the product surface.
- Never use abrasive cleansers. If any product feels gritty when rubbed between your fingers, do not use on the mineral composite surface or system controls as permanent damage will occur.

WARNING: Check cleaning and bathing product labels. Do not use unless the product label specifically states that it is safe for acrylic or plastic. Some non-abrasive products damage the surface over time.

General Care

- Do not allow the mineral composite surface to come into contact with nail polish, nail polish remover, Wintergreen oil, dry cleaning solution, lacquer thinners, gasoline, pine oil, etc.
- Avoid using razor blades or other sharp objects that might scratch the surface.
- The Manufacturer strongly recommends a professional surface repair person for deep scratches, chips or gouges.
- Damage occurring to the unit during installation is the responsibility of the installer, and after installation, the responsibility of the user.

Troubleshooting

Q: The blower will not turn on. What should I check first?

A: Check the electrical connections. Test the outlet for power. Check to make sure the breaker is not tripped. Replace GFCI outlet or breaker if necessary.

Q: There is a rust colored, greasy ring in my bath tub. What causes this?

A: The condition results from sediment in the water heater of the home. Drain and flush the heater according to the Manufacturer's instructions, and then clean the interior of the tub with a mild, grease cutting dish soap.

Q: The air jets on my tub are not blowing air bubbles. What could be the problem?

A: Check that the keypad is connected to the blower, and the blower is plugged into a working receptacle. Check that the gray air hose from the air blower to the manifold is properly secured.

Q: The airbath comes on when not in use.

A: Acquabella airbaths are equipped with an automatic purge / drying cycle. See pg. 11 for details.

Q: I understand the purge cycle, however my tub is now purging in the middle of the night. How can I stop this from happening?

A: Small, barely detectable power fluctuations can disrupt the purge cycle. Turn the breaker off (or unplug the blower), wait for ten seconds, then plug back in. The blower should now follow the normal purge cycle.

Q: The air bubbles seem cool. How do I check that the blower is warming the air?

A: To verify, turn the air system on high for 4-5 minutes (you do not need to have water in the tub). Carefully feel the gray air hose where it exits the blower. It should be warm to the touch. If it is cold, please contact Acquabella for service.

The heated blower is designed to preheat the incoming air and does not warm the bath water. If your tub is installed against an outside wall(s), it is recommended to adequately insulate the wall(s) to minimize heat loss. DO NOT insulate the blower itself; the blower needs sufficient air space surrounding it for proper circulation and operation.

Q: Can I relocate the blower?

A: The air blower can be located up to eight feet from the bath. See Airbath Installation in this manual.

Q: Is it safe to use bath salts or bath oils in my airbath?

A: Water soluble bath salts are fine to use, however, the Manufacturer does not recommend the use of heavy bath oils. Products containing natural or chemical dyes may discolor the air jets and/or tub surface. Check the label to ensure products are safe for acrylic or plastics, and always use according to the product recommendations. See the cleaning section of this manual for proper after care and cleaning instructions.

Q: My bath's hydrotherapy system has been working great for years, and now has stopped working. What should I check first?

A: Check breaker box first, then test the outlet. If problem persists, contact Acquabella with product serial number for assistance.

Q: How do I find the serial or registration number on my bath?

A: Look for the Acquabella decal on the airbath blower.

Q: The remote control for my air bath no longer functions. What can I do?

A: Barely detectable power fluctuations may occasionally disrupt the remote control. Read all 3 three steps below before beginning synchronization.

1. Turn off the breaker or unplug the blower for 30 seconds.
2. Within 15 seconds of restoring power, simultaneously press the "plus" and "minus" buttons, hold down for 4 seconds, and release. The remote is now ready for use.
3. If the synchronization is not successful, repeat the steps.

If the remote is still inoperable, contact Acquabella's service department. Please have your serial or registration number available.

Residential Limited Lifetime Product Warranty

MTI Baths, LLC (“Manufacturer”) offers this Residential Limited Lifetime Product Warranty (this “Limited Warranty”) to the original non-commercial purchaser¹ (“Purchaser”) of the Acquabella mineral composite tub (“Product” or “Products”).

1. Limited Warranty. Manufacturer warrants to Purchaser that, subject to the terms, conditions and limitations set forth herein, for the lifetime of the Product from the date of purchase, the Product shall be free of defects in material and workmanship. Notwithstanding the foregoing, (a) with respect to Product accessories manufactured by Manufacturer, Manufacturer warrants that such accessories shall be free of defects in material and workmanship for a period of one (1) year from the date of purchase of such accessory; and (b) with respect to hydrotherapy components, including Air Bath blowers, pumps, jets and keypads manufactured by Manufacturer, Manufacturer warrants that such components shall be free from defects in material and workmanship for a period of two (2) years from the date of purchase. Slight variations in the appearance of the natural stone shell, and blemishes, air holes or casting marks on the underside of the Product are excluded from this Limited Warranty. Display floor models and overstock sale units are excluded from this Limited Warranty. Drain kits and accessories that are manufactured by third parties are excluded from this Limited Warranty. Oral statements made by Manufacturer or its representatives and written descriptions of the Product other than as set forth in this Limited Warranty do not constitute a warranty on behalf of Manufacturer.

2. Application; Limitations; Exclusions. The Limited Warranty set forth in Section 1 is subject to the following limitations and conditions, and will be rendered null and void in the event of a failure to meet any of the following conditions:

- a. The Product must:
 - i. have been purchased from an authorized Acquabella distributor or retailer within the boundaries of the continental United States on or after March 1, 2023, paid for in full, and installed within the boundaries of the continental United States²;
 - ii. have been installed, maintained and used in strict accordance with instructions provided by Manufacturer, including without limitation maintenance and usage guidelines, and generally accepted standards;
 - iii. be used for the limited purposes of personal, family or single household purposes;
 - iv. have been installed in an indoor, climate-controlled, residential environment;
 - v. have been water tested for proper drainage, system operation, and leak detection prior to completion of installation;
 - vi. not have been altered, customized, modified or repaired, including without limitation, installing the Product with any accessories or by any means not approved in writing by Manufacturer, placing or attaching structures, fixtures or utilities upon or to the Product, installing vents or manual perforations or penetrations, in each case without having obtained prior written authorization from Manufacturer;
 - vii. not have been damaged:
 1. due to normal wear and tear;
 2. due to unauthorized or unreasonable use or improper handling, including without limitation, damages caused by overfilling a tub or by leaving a running or full tub unattended;
 3. by freight carriers, installers, users or other third parties;
 4. due to accidents or acts of God, including without limitation, earthquakes, floods, or other storms;
 5. due to failure to follow Product instructions; or
 6. due to incorrect operation or lack of proper routine maintenance, including without limitation, the use of improper cleaners or abrasives or from food, beverages, bathing products with harmful dyes or other contents, medicinal products, make-up or hair dye, cigarette burns or burns from hot appliances or other misuses of any kind.
- b. Manufacturer does not warrant the compatibility of the Product with any product manufactured by any third party.

¹ Commercial purchasers should refer to the Commercial Limited Two-Year Product Warranty.

² **THE FOLLOWING APPLIES TO ALASKAN AND CANADIAN NON-COMMERCIAL CUSTOMERS ONLY.** This Limited Warranty shall extend to any Product installed within a 75-mile radius of an authorized Acquabella distributor or retailer. Any Product installed outside the 75-mile radius shall be covered by this Limited Warranty for a period of two (2) years from the date of purchase, and shall be limited to parts replacement only. **THE FOLLOWING APPLIES TO HAWAIIAN NON-COMMERCIAL CUSTOMERS ONLY.** This Limited Warranty shall extend to any Product installed on the islands of Maui, Kauai and Oahu only. Any Product installed elsewhere in Hawaii shall be covered by this Limited Warranty for a period of two (2) years from the date of purchase, and shall be limited to parts replacement only.

- c. This Limited Warranty extends only to the original purchaser of the Product and shall terminate immediately: (i) upon any transfer of ownership of the Product; or (ii) if the Product is installed or relocated outside of the boundaries of the continental United States. Proof of purchase must be provided by Purchaser promptly upon Manufacturer's request.
- d. Purchaser must have registered the Product within one hundred twenty (120) days from the date of purchase. Registration may be completed online at <https://acquabella.us/contact-us/%20warranty-registration/> or mailed to Manufacturer at 670 N. Price Rd., Sugar Hill, Georgia 30518.
- e. Purchaser must have notified Manufacturer of any claim under this Limited Warranty in writing within ten (10) days of the date Purchaser discovers, or should have discovered, the issue giving rise to the claim. All such claims must be submitted to service@acquabella.us. To be valid, all claims must identify the date of discovery, a description of the defect, the name and address of the installer of the Product, the date and address of installation, and the type or style of the Product.
- f. Damages that occur in transit are the responsibility of the carrier. Purchaser or persons(s) acting on behalf of Purchaser must open and inspect the Product for damage when delivered. If the Product is damaged upon delivery, Purchaser must notify the carrier and Manufacturer in writing immediately and an inspection must be requested. All freight claims must be filed within ten (10) business days.

3. Warranty Performance; Limited Remedy. If the Product is the subject of a valid warranty claim in accordance with this Limited Warranty, Manufacturer will, at its sole option: (i) replace the defective Product; or (ii) repair or make appropriate adjustments to the Product. In no event will Manufacturer authorize any service unless clear access is available. The Manufacturer is not responsible for the provision of proper access. A minimum size of 16"x14" access to each component on the Product must be provided. Access from a crawlspace or incomplete access to all equipment may result in warranty claims being denied.

Manufacturer reserves the right to inspect the malfunction or defect on site and repair or replace the Product at its discretion. In all instances, a reasonable amount of time must be allowed for commencement and completion of warranty repairs, replacements, or adjustments. Repairs will be made by an authorized Acquabella repairer. Replacement parts and/or repair services authorized under the terms of this Limited Warranty will result in the issuance of a service order number. No payment for services rendered will be made by Manufacturer without an Acquabella authorized service order. Manufacturer cannot guarantee that the Product currently in use will be available in the future. Product replacement is subject to availability and replacement Products may differ from those originally supplied.

Manufacturer is not responsible for labor charges or other charges related to the removal or installation or other costs involved in repairing or replacing the Product or the expense of shipment to or from the factory, except where provided by applicable law. Manufacturer is not responsible for the cost of removing or reinstalling the Product or costs associated with any adjacent materials. Changes in materials, parts or specifications are not valid reasons for product refusal or replacement under warranty claims.

To the greatest extent permitted by applicable law, the remedy set forth in this Section 3 is the sole and exclusive remedy for any claim based on the Product's failure to meet this Limited Warranty. THIS LIMITED WARRANTY IS GIVEN IN LIEU OF ALL OTHER WARRANTIES OR CONDITIONS, STATUTORY OR OTHERWISE, EXPRESS OR IMPLIED, INCLUDING THE WARRANTY OF MERCHANTABILITY AND FITNESS FOR A PARTICULAR PURPOSE, AND THE CONDITION OF MERCHANTABILITY AND FITNESS FOR A PARTICULAR PURPOSE, WHETHER EXPRESS OR IMPLIED BY LAW, COURSE OF DEALING, COURSE OF PERFORMANCE, USAGE OF TRADE OR OTHERWISE.

4. Disclaimer. TO THE GREATEST EXTENT PERMITTED BY APPLICABLE LAW, IN NO EVENT WILL MANUFACTURER'S LIABILITY EXCEED THE PURCHASE PRICE PAID TO MANUFACTURER FOR THE DEFECTIVE PRODUCT. MANUFACTURER WILL HAVE NO LIABILITY WHATSOEVER FOR ANY INCIDENTAL, SPECIAL, INDIRECT, CONSEQUENTIAL, OR PUNITIVE DAMAGES IN CONNECTION WITH THE PRODUCT OR ITS USE, WHETHER OR NOT FORSEEABLE AND WHETHER OR NOT WARRANTOR HAS BEEN ADVISED OF THE POSSIBILITY OF SUCH DAMAGES. MANUFACTURER WILL NOT BE LIABLE FOR WATER DAMAGE TO CARPETING, FLOORS OR CEILINGS.

5. Additional Information. To obtain additional information about this Limited Warranty or Manufacturer's obligations please contact the Acquabella Service Department at 800.783.8827 or email service@acquabella.us. Must have registration number available.

6. Waiver. Any failure of Manufacturer to enforce any terms and conditions set forth in this Limited Warranty shall not be deemed a waiver of such provision.

7. Entire Agreement. This writing constitutes the final, complete, and exclusive expression of the terms of the parties' agreement. Any modifications hereof, to be effective, shall be in writing, shall expressly refer to this Limited Warranty, and shall be signed by an authorized representative of the parties hereto.

8. Governing Law. This Limited Warranty shall be governed by and construed in accordance with the laws of the State of Georgia, without regard to the laws of such jurisdiction relating to conflicts of laws.

9. Severability. In the event that any provision contained herein shall be deemed invalid, illegal or unenforceable in any respect in any jurisdiction, all remaining provisions shall remain in effect and such invalid, illegal or unenforceable provision shall be reformed so that it would be valid, legal and enforceable to the maximum extent permitted.

Commercial Limited Two-Year Product Warranty

MTI Baths, LLC (“Manufacturer”) offers this Commercial Limited Two-Year Product Warranty (this “Limited Warranty”) to the original commercial purchaser³ (“Purchaser”) of the Acquabella mineral composite tub (“Product” or “Products”).

1. Limited Warranty. Manufacturer warrants to Purchaser that, subject to the terms, conditions and limitations set forth herein, for a period of two (2) years from the date of purchase, the Product shall be free of defects in material and workmanship. Notwithstanding the foregoing, (a) with respect to Product accessories manufactured by Manufacturer, Manufacturer warrants that such accessories shall be free of defects in material and workmanship for a period of one (1) year from the date of purchase of such accessory; and (b) with respect to hydrotherapy components, including Air Bath blowers, pumps, jets and keypads manufactured by Manufacturer, Manufacturer warrants that such components shall be free from defects in material and workmanship for a period of two (2) years from the date of purchase. Slight variations in the appearance of the natural stone shell, and blemishes, air holes or casting marks on the underside of the Product are excluded from this Limited Warranty. Display floor models and overstock sale units are excluded from this Limited Warranty. Drain kits and accessories that are manufactured by third parties are excluded from this Limited Warranty. Oral statements made by Manufacturer or its representatives and written descriptions of the Product other than as set forth in this Limited Warranty do not constitute a warranty on behalf of Manufacturer.

2. Application; Limitations; Exclusions. The Limited Warranty set forth in Section 1 is subject to the following limitations and conditions, and will be rendered null and void in the event of a failure to meet any of the following conditions:

- a. The Product must:
 - i. have been purchased from an authorized Acquabella distributor or retailer within the boundaries of the continental United States on or after March 1, 2023, paid for in full, and installed within the boundaries of the continental United States⁴;
 - ii. have been installed, maintained and used in strict accordance with instructions provided by Manufacturer, including without limitation maintenance and usage guidelines, and generally accepted standards;
 - iii. have been installed in an indoor, climate-controlled, commercial environment;
 - iv. have been water tested for proper drainage, system operation, and leak detection prior to completion of installation;
 - v. not have been altered, customized, modified or repaired, including without limitation, installing the Product with any accessories or by any means not approved in writing by Manufacturer, placing or attaching structures, fixtures or utilities upon or to the Product, installing vents or manual perforations or penetrations, in each case without having obtained prior written authorization from Manufacturer;
 - vi. not have been damaged:
 1. due to normal wear and tear;
 2. due to unauthorized or unreasonable use or improper handling, including without limitation, damages caused by overfilling a tub or by leaving a running or full tub unattended;
 3. by freight carriers, installers, users or other third parties;
 4. due to accidents or acts of God, including without limitation, earthquakes, floods, or other storms;
 5. due to failure to follow Product instructions; or
 6. due to incorrect operation or lack of proper routine maintenance, including without limitation, the use of improper cleaners or abrasives, or from food, beverages, bathing products with harmful dyes or other contents, medicinal products, make-up or hair dye, cigarette burns or burns from hot appliances or other misuses of any kind.
- b. Manufacturer does not warrant the compatibility of the Product with any product manufactured by any third party.
- c. This Limited Warranty extends only to the original purchaser of the Product and shall terminate immediately: (i) upon any transfer of ownership of the Product; or (ii) if the Product is installed or relocated outside of the boundaries of the continental United States. Proof of purchase must be provided by Purchaser promptly upon Manufacturer’s request.

³ Residential purchasers should refer to the Residential Limited Lifetime Product Warranty.

⁴ **THE FOLLOWING APPLIES TO ALASKAN AND CANADIAN NON-COMMERCIAL CUSTOMERS ONLY.** This Limited Warranty shall extend to any Product installed within a 75-mile radius of an authorized Acquabella distributor or retailer. Any Product installed outside the 75-mile radius shall be covered by this Limited Warranty for a period of two (2) years from the date of purchase, and shall be limited to parts replacement only. **THE FOLLOWING APPLIES TO HAWAIIAN NON-COMMERCIAL CUSTOMERS ONLY.** This Limited Warranty shall extend to any Product installed on the islands of Maui, Kauai and Oahu only. Any Product installed elsewhere in Hawaii shall be covered by this Limited Warranty for a period of two (2) years from the date of purchase, and shall be limited to parts replacement only.

- d. Purchaser must have registered the Product within one hundred twenty (120) days from the date of purchase. Registration may be completed online at <https://acquabella.us/contact-us/%20warranty-registration/> or mailed to Manufacturer at 670 N. Price Rd., Sugar Hill, Georgia 30518.
- e. Purchaser must have notified Manufacturer of any claim under this Limited Warranty in writing within ten (10) days of the date Purchaser discovers, or should have discovered, the issue giving rise to the claim. All such claims must be submitted to service@acquabella.us. To be valid, all claims must identify the date of discovery, a description of the defect, the name and address of the installer of the Product, the date and address of installation, and the type or style of the Product.
- f. Damages that occur in transit are the responsibility of the carrier. Purchaser or persons(s) acting on behalf of Purchaser must open and inspect the Product for damage when delivered. If the Product is damaged upon delivery, Purchaser must notify the carrier and Manufacturer in writing immediately and an inspection must be requested. All freight claims must be filed within ten (10) business days.

3. Warranty Performance; Limited Remedy. If the Product is the subject of a valid warranty claim in accordance with this Limited Warranty, Manufacturer will, at its sole option: (i) replace the defective Product; or (ii) repair or make appropriate adjustments to the Product. The Manufacturer is not responsible for the provision of proper access. A minimum size of 16"x14" access to each component on the Product must be provided. Access from a crawlspace or incomplete access to all equipment may result in warranty claims being denied.

Manufacturer reserves the right to inspect the malfunction or defect on site and repair or replace the Product at its discretion. In all instances, a reasonable amount of time must be allowed for commencement and completion of warranty repairs, replacements, or adjustments. Repairs will be made by an authorized Acquabella repairer. Replacement parts and/or repair services authorized under the terms of this Limited Warranty will result in the issuance of a service order number. No payment for services rendered will be made by Manufacturer without an Acquabella authorized service order. Manufacturer cannot guarantee that the Product currently in use will be available in the future. Product replacement is subject to availability and replacement Products may differ from those originally supplied.

Manufacturer is not responsible for labor charges or other charges related to the removal or installation or other costs involved in repairing or replacing the Product or the expense of shipment to or from the factory, except where provided by applicable law. Manufacturer is not responsible for the cost of removing or reinstalling the Product or costs associated with any adjacent materials. Changes in materials, parts or specifications are not valid reasons for product refusal or replacement under warranty claims.

The remedy set forth in this Section 3 is the sole and exclusive remedy for any claim based on the Product's failure to meet this Limited Warranty. THIS LIMITED WARRANTY IS GIVEN IN LIEU OF ALL OTHER WARRANTIES OR CONDITIONS, STATUTORY OR OTHERWISE, EXPRESS OR IMPLIED, INCLUDING THE WARRANTY OF MERCHANTABILITY AND FITNESS FOR A PARTICULAR PURPOSE, AND THE CONDITION OF MERCHANTABILITY AND FITNESS FOR A PARTICULAR PURPOSE, WHETHER EXPRESS OR IMPLIED BY LAW, COURSE OF DEALING, COURSE OF PERFORMANCE, USAGE OF TRADE OR OTHERWISE.

4. Disclaimer. IN NO EVENT WILL MANUFACTURER'S LIABILITY EXCEED THE PURCHASE PRICE PAID TO MANUFACTURER FOR THE DEFECTIVE PRODUCT. MANUFACTURER WILL HAVE NO LIABILITY WHATSOEVER FOR ANY INCIDENTAL, SPECIAL, INDIRECT, CONSEQUENTIAL, OR PUNITIVE DAMAGES IN CONNECTION WITH THE PRODUCT OR ITS USE, WHETHER OR NOT FORSEEABLE AND WHETHER OR NOT WARRANTOR HAS BEEN ADVISED OF THE POSSIBILITY OF SUCH DAMAGES. MANUFACTURER WILL NOT BE LIABLE FOR WATER DAMAGE TO CARPETING, FLOORS OR CEILINGS.

5. Additional Information. To obtain additional information about this Limited Warranty or Manufacturer's obligations please contact the Acquabella Service Department at 800.783.8827 or email service@acquabella.us. Must have registration number available.

6. Waiver. Any failure of Manufacturer to enforce any terms and conditions set forth in this Limited Warranty shall not be deemed a waiver of such provision.

7. Entire Agreement. This writing constitutes the final, complete, and exclusive expression of the terms of the parties' agreement. Any modifications hereof, to be effective, shall be in writing, shall expressly refer to this Limited Warranty, and shall be signed by an authorized representative of the parties hereto.

8. Governing Law. This Limited Warranty shall be governed by and construed in accordance with the laws of the State of Georgia, without regard to the laws of such jurisdiction relating to conflicts of laws.

9. Severability. In the event that any provision contained herein shall be deemed invalid, illegal or unenforceable in any respect in any jurisdiction, all remaining provisions shall remain in effect and such invalid, illegal or unenforceable provision shall be reformed so that it would be valid, legal and enforceable to the maximum extent permitted.

