



PIONEER INDUSTRIES, INC.
 3325 S. Garfield Ave.
 Commerce, CA 90040
 (800) 338-9468
 www.pioneerind.com

INSTALLATION

Tools:



Adjustable Wrench



Plumbers Putty



Teflon Tape



Rags

Model Number: 3LG100, 3LG100B, 3LG101, 3LG102, 3LG102B, 3LG110, 3LG111, 3LG121, 3LG121G, 3LG130, 3LG140



Warnings and Notes:

Check with local plumbing code requirements before installation.
 This product should be installed by a local listed plumber.
Do not use plumbers putty on threads.

Installation Steps:

Two Handle Lavatory Faucet

Pop-up Drain Installation:

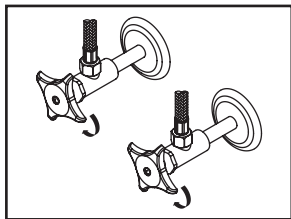

(1) Shut off water supplies. Remove old faucet. Clean mounting surface in preparation for new faucet.

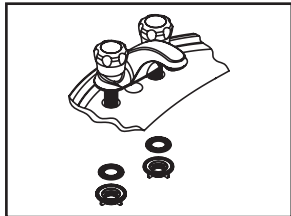

(2) Apply plumbers putty under the base gasket. Place the faucet in position on the sink. Install washer on shanks and tighten with locknut.

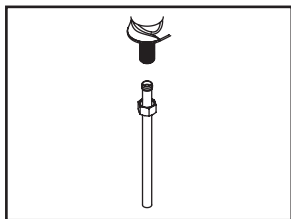

(3a) when using ball-nose flexible supplies to connect faucet to water supply valves, slip coupling nut onto flexible supply. Ball-nose coupling will go partially into shank. Tighten coupling nut (DO NOT OVERTIGHTEN). Install opposite end according to manufacturer's instruction for both tubes.

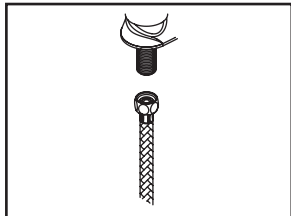

(3b) when using stainless steel braided faucet supply hose; this faucet requires one end of the supply hose to have a 1/2" female IPS connection. The other end of this supply hose must match the thread on the water supply valve under your sink. Once you've identified the required size, carefully follow the manufacturer's installation instructions for each hose.

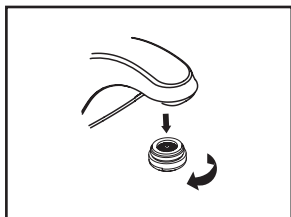

(4) Important: After installation is complete, remove aerator. Turn water supplies on and allow both hot and cold water to run at least one minute each. While water is running, check for leaks. Turn off water and replace aerator.

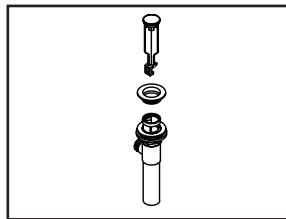

(1) Remove pop-up flange from body

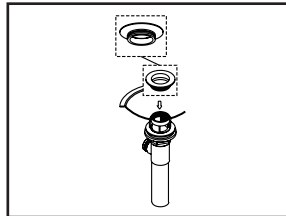

(2) Place a ring of putty on the bottom of flange.

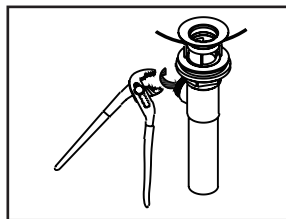

(3) Insert pop-up flange through drain hole and attach flange to body. Ensure the pop-up outlet faces towards the back of the sink. Tighten the locknut securely with a wrench. Do not overtighten.

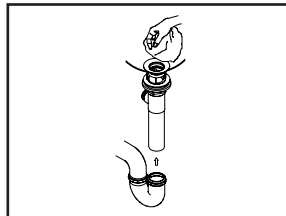

(4) Remove the excess putty. Connect the trap (check manufacturer's instructions for installation)

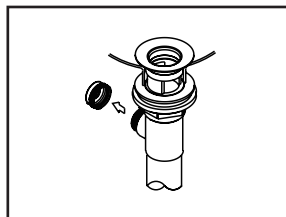

(5) Remove pivot rod nut from pop-up body, ensure the washers is in place, insert pivot rod, tighten pivot rod nut back to pop-up body.

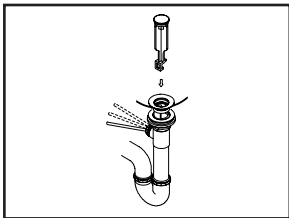

(6) Push pivot rod down, insert drain plug carefully. Test to ensure drain plug works properly.

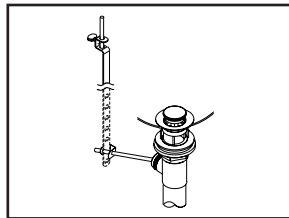

(7) Connect lift rod strap to pivot rod by using clip. Tighten the thumbscrew to connect lift rod strap to pop-up lift rod.

Exploded Drawing :

* Note: Please specify finish/color when ordering.

	ITEM #	DESCRIPTION
1	X-4900005C,H	Acrylic Handle Button -Cold, Hot
2	X-4900006	Handle Screw
3	X-4900009C,H	Mini Blade Handle Button -Cold, Hot
4	X-4900066	Handle Screw
5	X-4900010*	Screw
6	X-4900011C,H	Wrist Blade Handle Button -Cold, Hot
7	X-4900014C,H*	Lever Handle Button -Cold, Hot
8	X-4900015	Handle Screw
9	X-4900042C, H*	Lever Handle Button -Cold, Hot
10	X-4900061	Handle Screw

	ITEM #	DESCRIPTION
A	X-1900001C, H	Acrylic Handle- Cold, Hot (For 3LG100, 3LG100B, 3LG101, 3LG102, 3LG102B)
B	X-1900002C, H*	Mini Blade Handle- Cold, Hot (For 3LG110, 3LG111)
C	X-1900003C, H*	Wrist Blade Handle- Cold, Hot (For 3LG121, 3LG121G)
D	X-1900004C, H*	Lever Handle- Cold, Hot (For 3LG130)
E	X-1900009C, H*	Lever Handle- Cold, Hot (For 3LG140)
F	X-4900007	Bonnet Nut
G	X-3900002C	Ceramic Disc Stem - Cold
H	X-3900002H	Ceramic Disc Stem - Hot
I	X-4300058*	1.5 GPM Aerator
J	X-4900008	Mounting Locknut & Washer
K	X-4900004	Supply Nuts
L	X-6300001*	Brass Pop-Up Drain Assembly (For 3LG100, 3LG100B, 3LG110, 3LG130)
L	X-6300023*	50/50 Drain Assembly (For 3LG102, 3LG102B)
M	X-6300002*	Brass Grid Strainer (For 3LG121G)

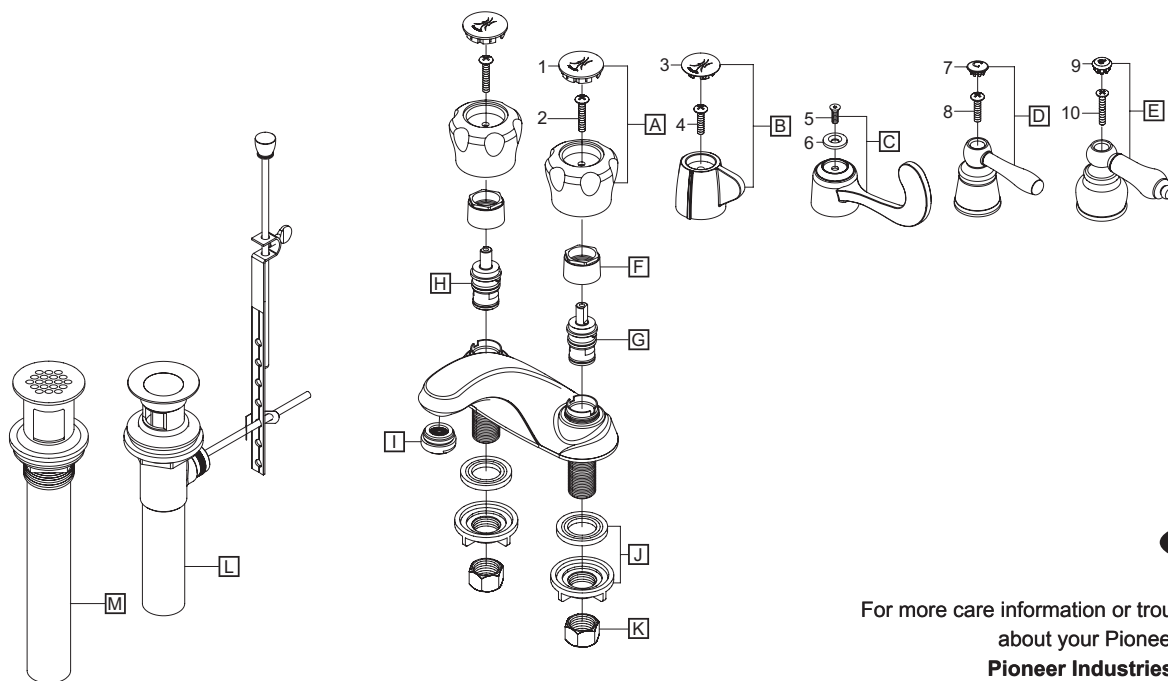

For more care information or trouble shooting inquiries about your Pioneer product, please call:
Pioneer Industries, Inc. (800) 338-9468
 Monday-Friday 8AM to 8PM EST (5AM to 5PM PST)
www.pioneerind.com