

K8161H



■ **PRODUCT FEATURES**

-
-
-
-
-

■ **TECHNICAL DETAILS**

ADA Compliance: Yes
 Deck Thickness Maximum: 2"
 Deck Thickness Minimum: 1/8"
 Fitting Hole Diameter: 1 1/8 - 1 3/8"
 Number of Holes: 1
 Number of Handles: 2
 Hand Turn Angle: 90°
 Spout Reach: 9 1/2"
 Spout Height: 14 11/16"
 Inlet Connection Type: 3/8" Compression
 Installation Type: Deck Mounted
 Primary Material: Brass
 Valve Material: Ceramic
 Flow Restriction: 2.2 gpm max
 Water Pressure Maximum: 85 PSI
 Water Pressure Minimum: 20 PSI

■ **PRODUCT DIMENSIONS**

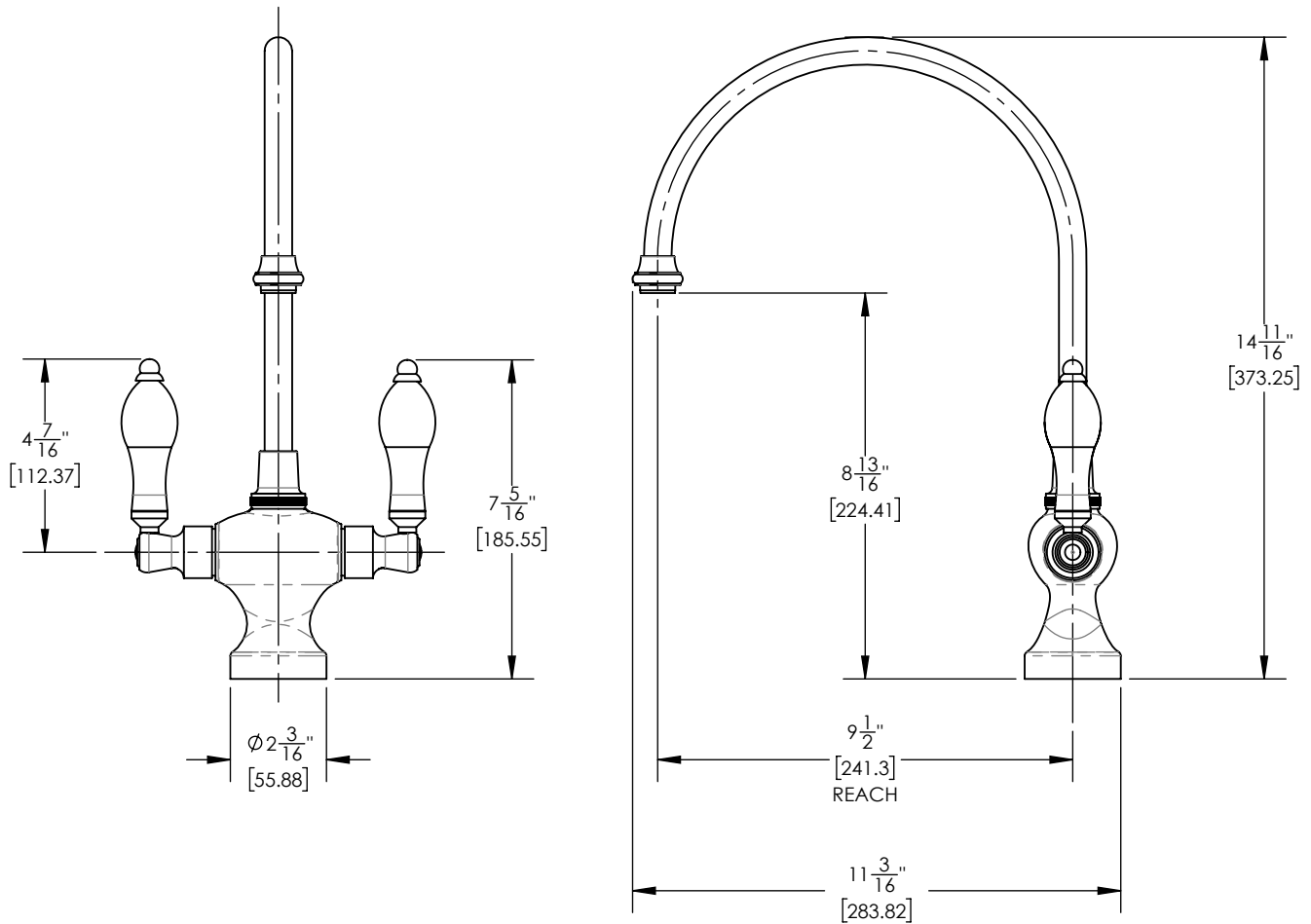

www.phylrich.com

1261 Logan Avenue, Costa Mesa, California 92626.
 Phone: 714.361.4800 Fax: 714.617.3120



CODES & STANDARDS

ASME A112.181/ CSA B1251, ASME 112.18.2/ CSA B125.2, ANSI NSF, CEC

WARRANTY

Mechanical Warranty: 10 Years from date of purchase.
 Finish Warranty: See catalog for further information.

Rev-