

121-71

■ **PRODUCT FEATURES**

- Style: Transitional
- Collection: Transition 2

■ **TECHNICAL DETAILS**

ADA Compliance: No
 Installation Type: Wall Mounted
 Primary Material: Brass



■ **PRODUCT DIMENSIONS**

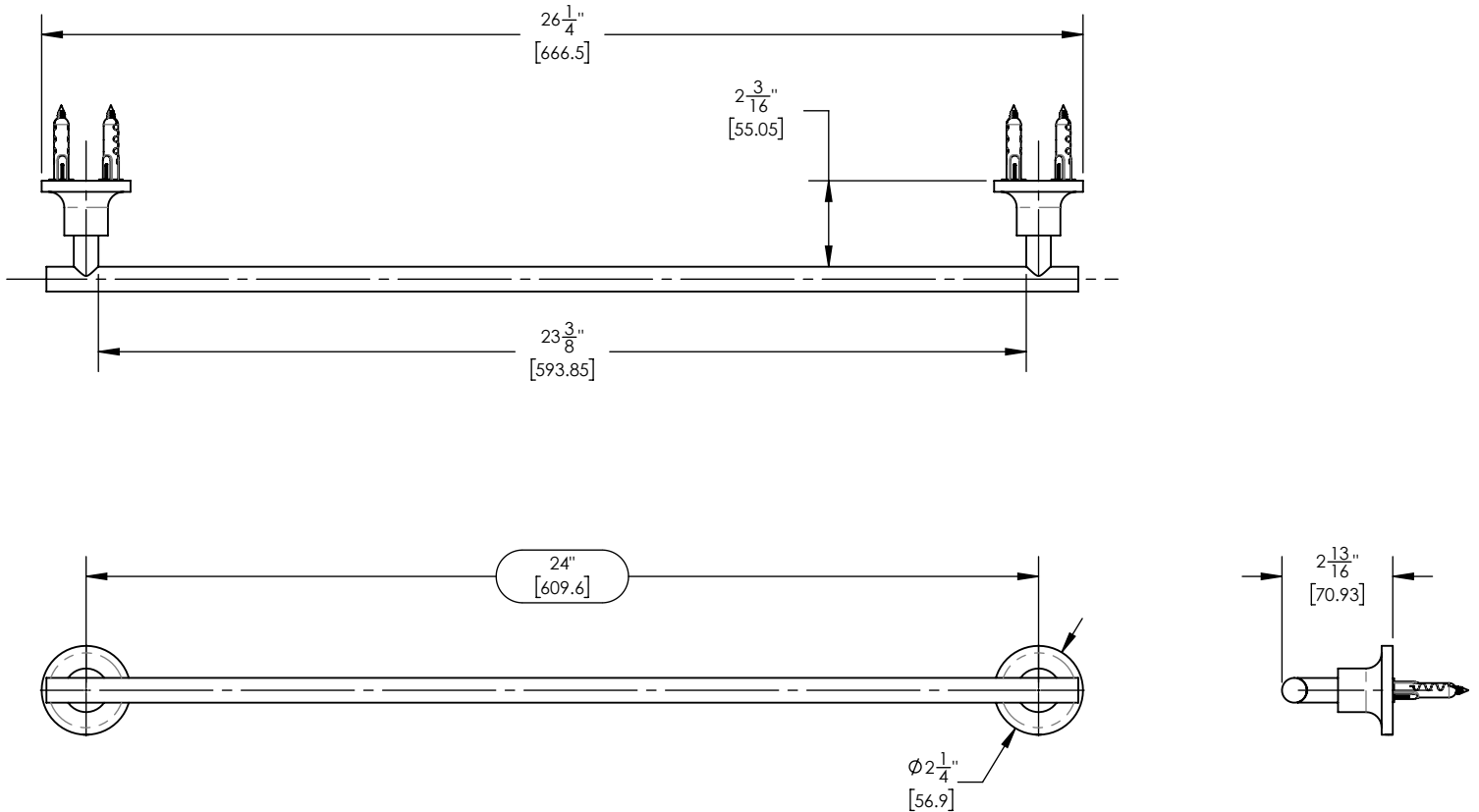

www.phylrich.com

1261 Logan Avenue, Costa Mesa, California 92626.
 Phone: 714.361.4800 Fax: 714.617.3120



CODES & STANDARDS

ASME A112.181/ CSA B1251, ASME 112.18.2/ CSA B125.2, ANSI NSF, CEC

WARRANTY

Mechanical Warranty: 10 Years from date of purchase.
 Finish Warranty: See catalog for further information.

Rev-