

**Outdoor Shower Company, LLC**  
 Dallas, Georgia  
 www.outdoorshowerco.com—1-866-shower1  
*Manufacturers of Quality Stainless Steel Showers*



**WALL MOUNT COLD WATER—WM-442-ADA / WM-442-CHV**

**WM-442-CHV**

**WM-442-ADA**

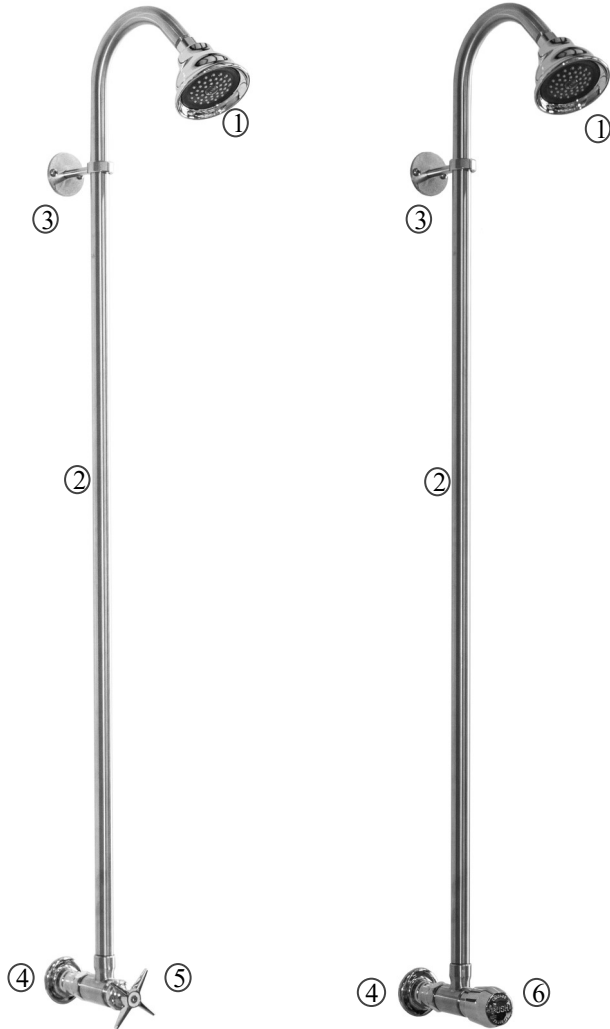

**WM-442 PARTS LIST**

1) DEL-78	1.75 GPM Chrome Plated Head
2) SR-41-120	½"x 41" 304 sch40 Stainless Steel Riser
3) WB-3	3" Stainless Steel Wall Bracket & Flange w/Stainless Steel Screws (2)
4) WJK-CP	Straight Supply Arm with Flange
5) AV-CH-SS	Cross Handle Stainless Steel Angle Valve (replacement valve for WM-442-CHV)
6) AV-ADA-SS	Metered Push Handle Stainless Steel Angle Valve (replacement valve for WM-442-ADA)

Accessories may vary due to availability and slight modifications by the manufacturer.

Additional options/accessories are available and shown on page 3.

**Installation Guidelines**

- Recommended Water Supply Line from flooring surface: 40-42"
  - Recommended Shower Head Height: 77-79"
1. Bring ½" water supply line out of wall leaving 1" of exposed pipe threads.
  2. Attach the WJK-CP Supply Arm to the water supply line.
  3. Slide mounting bracket onto riser.
  4. Attach shower riser to angle valve using Teflon tape on threads.
  5. Connect angle valve to WJK-CP making sure provided washer is used.
  6. Using a level or plumb line, mark placement holes for mounting bracket.
  7. Pre-drill previously marked holes for placement of mounting bracket.
  8. Secure mounting bracket to wall with stainless steel screws.
  9. Tighten set screw on ring of mounting bracket.
  10. Attach Shower Head to Riser. Teflon tape is not needed.

WALL MOUNT COLD WATER—WM-442-ADA / WM-442-CHV



www.outdoorshowerco.com  
1-866-shower1 (746-9371)  
info@outdoorshowerco.com

WM-442-ADA  
WM-442-CHV

WM-442-CHV  
FRONT VIEW

WM-442-CHV  
SIDE VIEW

WM-442-ADA  
FRONT VIEW

WM-442-ADA  
SIDE VIEW

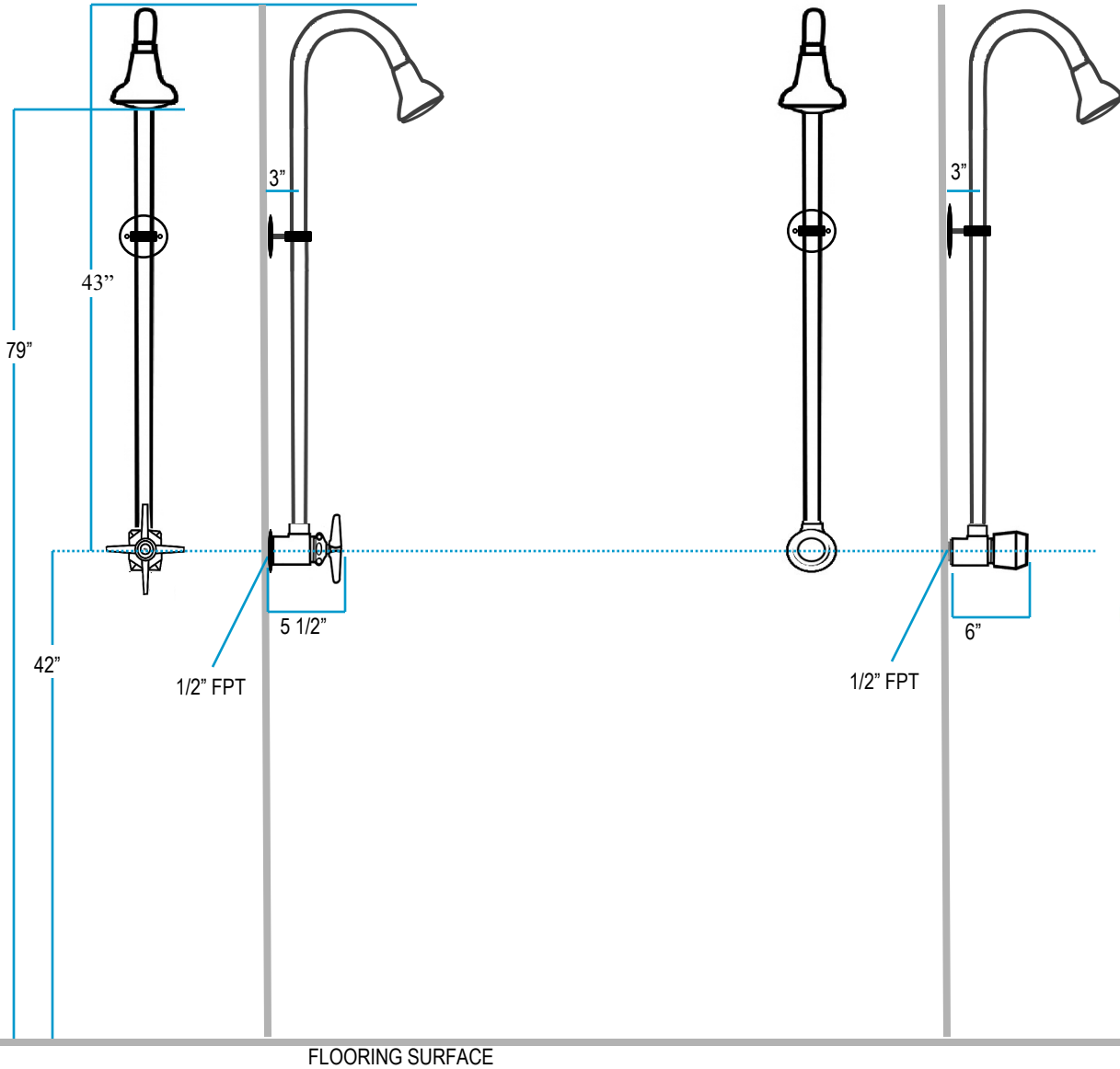

**TECHNICAL DATA:**

- WALL MOUNT UNIT
- STAINLESS STEEL ANGLE VALVE
- 1/2" x 41" 304 STAINLESS STEEL SCH 40 RISER
- 2.0 GPM CHROME PLATED SHOWER HEAD
- STAINLESS STEEL RING BRACKET
- STAINLESS STEEL SCREWS

# WM-442-ADA / WM-442-CHV ACCESSORIES & REPLACEMENT PARTS

## CROSS HANDLE ANGLE VALVE

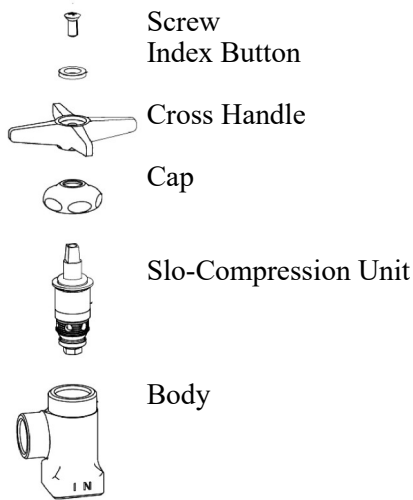

## ADA METERED ANGLE VALVE

### OPERATES FOR 5 TO 30 SECONDS VALVE CLOSES WITH WATER PRESSURE

Time is changed by rotating plastic-serrated adjustment nut with a pair of pliers. Raising nut (counter clockwise) shortens time, lowering nut (clockwise) lengthens time. Once cycle time is satisfactory, lock handle in place making sure set screw is securely fastened on groove in stem. Replace button. Tighten the actuator assembly onto the body to approximately 20 ft. lbs., (Hand tighten and give the actuator assembly a 1/2 to 1 full turn with a wrench).

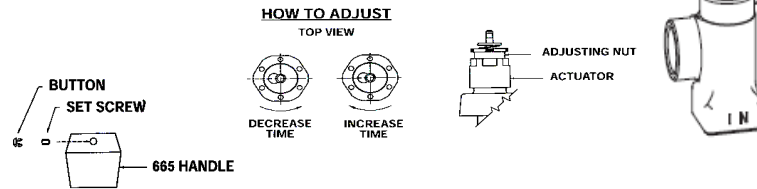
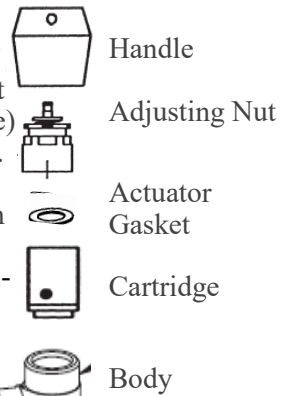

**NOTE:** Flush supply lines before installing valve to remove chips and dirt which can become lodged in the seat washer and cause the faucet to malfunction.

**FREEZE DAMAGE IS NOT COVERED BY WARRANTY.**

**WINTERIZING:** It is recommended that a shut-off valve be installed in the water line going to the pool shower connection where freezing temperatures can occur. Accessories can be removed and other parts partially disassembled for complete protection against freeze damage.

## ADDITIONAL OPTIONS & ACCESSORIES

### AVAILABLE WITH A FOOT SHOWER STAINLESS STEEL VALVES

#### WM-442-CHV-FS

#### WM-442-ADA-FS

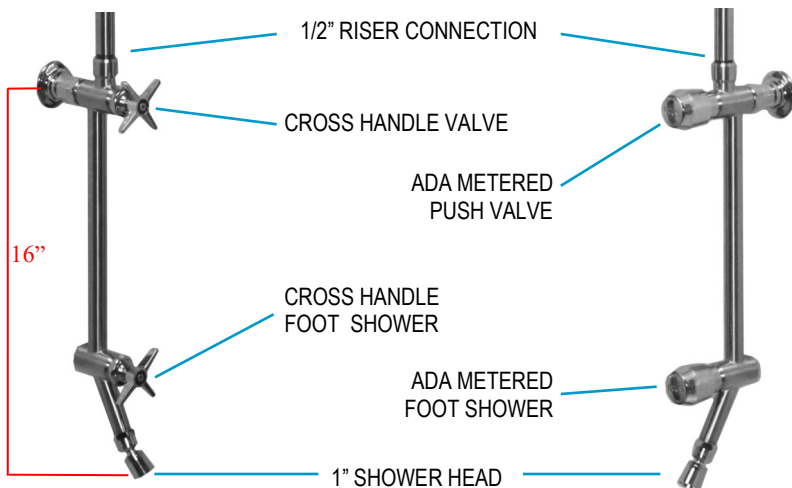

### PULL CHAIN VALVE PART #WM-442-PCV

- 8" Chrome Plated Brass Shower Head
- Chrome Plated Brass Self-closing Valve
- Stainless Steel Chain & Handle
- (2) 2" Wall Brackets
- Stainless Steel 1/2" Elbow
- 3" Stainless Steel Nipple
- 1/2" Stainless Steel Riser/ Arm

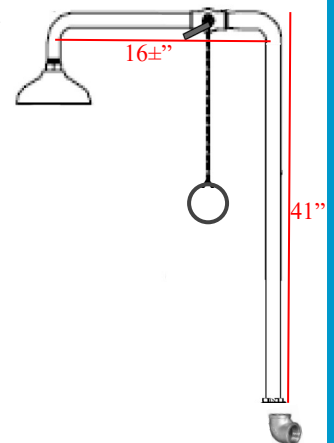

### AVAILABLE WITH HOSE BIBB

USE PART #WM-442-ADA-HB OR WM-442-CHV-HB

- STAINLESS STEEL VALVE BODY
- CHROME PLATED BRASS VACUUM BREAKER WITH 3/4" MHT



Shower Units with 6" or larger Shower Heads will come with 90° upgraded Riser.

Accessories may vary due to availability and slight modifications by the manufacturer.

# WARRANTY / RETURN POLICY MAINTENANCE



All items manufactured by Outdoor Shower Company, LLC. are manufactured in Dallas, Georgia, and we guarantee 100% customer satisfaction. Only the finest stainless steel materials are used. Each piece is individually crafted and is electro-polished, which smooths, polishes, and deburrs the product surface, making it easier to clean and resistant to contamination.

Stainless steel materials come with a ten (10) year limited warranty against defect and workmanship. All accessories not manufactured by Outdoor Shower Company, LLC. are covered by warranty for a period of two (2) year from the receipt by the original purchaser. This warranty will become void if merchandise is damaged, improperly maintained or installed, or modified without the authorization from our licensed distributor.

The warranties include replacement or repair of defective parts and an unconditional guarantee against manufacturing defects. The company will replace or repair at its option any equipment manufactured or supplied as part of our merchandise found to be defective if the conditions are met. Any shipping fees associated with the return or replacement of merchandise covered by this warranty will be incurred by Outdoor Shower Company, LLC. **We reserve the right to determine if damage to a unit or any parts is the direct cause of not complying with manufacturer's guidelines. Special Order non-stock items are NOT returnable.**

**WARNING: FREEZE DAMAGE is NOT covered by the warranty.**

**It is very important to winterize outdoor showers. Just like water faucets and hose bibbs, they are susceptible to freeze damage. The unit(s) must be drained in freezing conditions. In extremely cold temperatures it is advisable to remove faucets and hose bibbs and store them during winter months. Vented plugs are available through Outdoor Shower Company, LLC.**

Although care was taken in the design and manufacture of your new pool shower to ensure it's safe operation, we accept no responsibility for the improper use or installation of equipment, as it is no longer in our control. Buyers have the right of inspection, approval, and acceptance within thirty days of arrival.

We will not be responsible for transportation or labor for items returned for repair or replacement of parts where the merchandise was not properly installed or maintained. An authorized distributor must request a Return Authorization Form from Outdoor Shower Company, LLC., and submit it before the return can be approved. A 20% re-stock fee and the cost of shipping will be withheld on returns.

Our Customer Service Department is available for ordering replacement parts or if it should become necessary for you to return your Pool Shower unit. We can also repair or replace damaged parts for a minimal fee. Call **678-363-3939** or **1-866-SHOWER1** for return authorization and instructions, or E-mail us at [info@outdoorshowerco.com](mailto:info@outdoorshowerco.com). Additional information is available at [www.outdoorshowerco.com](http://www.outdoorshowerco.com).

**CAUTION:** Where outdoor temperatures reach more than 90 degrees use caution to prevent burns to skin from scalding water. When a shower unit is connected to an exposed water hose, it is recommended that a light colored hose be used in order to reduce solar gain and keep water temperature inside the hose near the ambient temperature. Water is stored in the body of the shower unit when not in use, and although the patented satin finish on our stainless steel components has minimal solar gain, in warm climates water temperatures inside the hose or shower unit can reach more than 110° which can result in minor burns to delicate skin tissue.

**HOT & COLD SHOWER UNITS:** Some states require Pressure Balancing Valves for hot & cold valves. These are available through any plumbing supply company and can be added to the water supply lines feeding into the shower valve. When hot water is used for bathing it is always recommended that the temperature on the water heater be set at 110° or less in order to prevent the risks of minor burns from scalding water.

Outdoor Shower Company, LLC. does not accept responsibility for bodily injury caused from improper use of its equipment or failure to use caution when operating the shower unit(s). It is recommended that the shower unit(s) be turned on for 30 seconds before contact with water spray in order to avoid accidental scalding and ensure safe use of this product.

Stainless steel does not "rust" as you think of regular steel rusting with a red oxide on the surface that flakes off. If you see red rust it is probably because the product was contaminated, steel or iron scratched the surface, and particles became embedded in the surface. These particles are much less corrosion resistant than the stainless steel and rust, making it appear that the stainless steel is rusting. Stainless steel should never be cleaned with steel wool or an abrasive cleaner. Brillo and S.O.S. pads are made of steel wire. Iron particles from these pads will contaminate the surface. NEVER use an iron-based product on stainless steel. Damp steel or cast iron can be left behind causing the stainless steel to stain (rust). In most cases, light staining can be removed with a fine abrasive cleaner, scouring powder, or non-metallic abrasive scouring pad such as a Scotch Brite® pad. Apply the cleaning product in the same direction as the polish to minimize damage. Stainless Steel cleaner is suggested and can be purchased at most home improvement stores. WD-40 is also an excellent cleaner and polisher of stainless steel. If there are obvious polishing lines rub in the same direction as the grain of the steel to minimize surface finish damage.