

# JSG Oceana Cubix Vessel

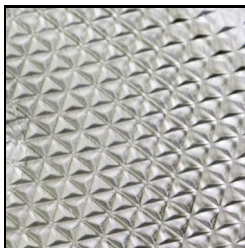

- Rim: Flat
- Design: Cube Pattern
- Model: 005-016-xxx
- Drain Hole: 1 3/4"
- Available in 5 lustrous colorations
- Length: 15 3/4"
- Width: 15 3/4"
- Diagonal: 19 5/8"
- Height: 4.5"
- Depth: 4"



**Crystal**  
005-016-000

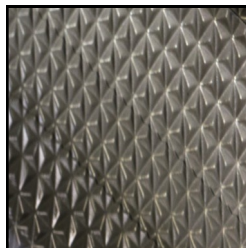

**Black Nickel**  
005-016-022

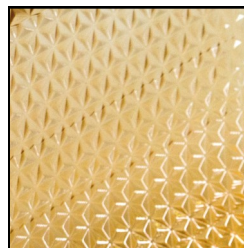

**Champagne Gold**  
005-016-100

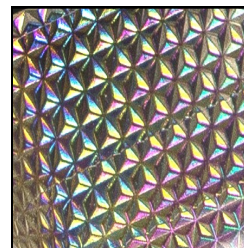

**Crystal Reflections**  
005-016-300

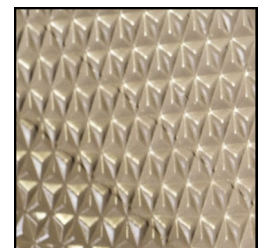

**Fawn**  
005-016-120

JSG Oceana Lustrous coloration samples are only representations of color. No two sinks are exactly alike.



215 North 4<sup>th</sup> Street, Jeannette, PA 15644 ph:724.523.5567 fax:724.523.0123 www.jsgoceana.com

Made in the U.S.A.

# JSG Oceana Cubix Vessel

**VESSEL SINK MODEL #005-016-XXX**

*Scratch Resistant • Stain Resistant • Thermal Shock Resistant • IAPMO Certified & UPC Approved*

## Product Information & Diagram

Fixture*		basin area	water depth
Sink		15 <sup>3</sup> / <sub>4</sub> " x 15 <sup>3</sup> / <sub>4</sub> "	4"
Drain	1 <sup>3</sup> / <sub>4</sub> "		

\*Approximate measurements for comparison only.

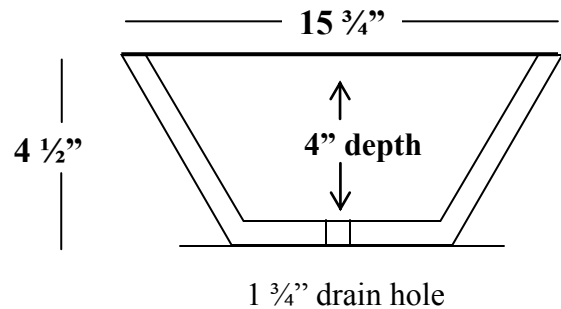

## Vessel Installation Instructions

**JSG Oceana recommends that Vessel sinks and routing of your solid surface material should be installed by a professional installer for best results.**

**The physical use of the sink will assure a more accurate cutout.**

The instructions that follow are for installing a JSG *Oceana* Vessel glass sink on top of a solid surface countertop only. Minimum thickness of the actual countertop is 1/2".

Requirements vary for installation in a granite, marble, stone or synthetic countertop. Please contact your fabricator for specific details.

**Before installing, inspect the sink for damage. Do not install a damaged unit. No returns accepted after installation, unless product is mechanically defected. Store the sink in the protective carton whenever possible.**

Remember, it is your responsibility to follow all local plumbing and building codes.

The warranty will be voided if these installation instructions are not followed.

- Drill a hole in countertop slightly larger than the width of your drain. (no less than 1 3/8" and no larger than 1 1/2").
- Place a rubber washer and/or apply a thin bead of caulking between vessel and countertop as a buffer.
- Apply thin layer of plumber's putty under rim of drain and place into sink. Drain will go through vessel and hole in countertop.
- Hand tighten drain underneath countertop. **DO NOT OVERTIGHTEN.**
- If the drain does not have enough threads to tighten completely up to the countertop, purchase a piece of PVC pipe to make-up the difference. Use two rubber washers to seal the PVC pipe and prevent leakage. (PVC pipe can also be used if you purchase a drain with an overflow hole.)
- Clear caulking or epoxy can also be applied between vessel and countertop for added stability.

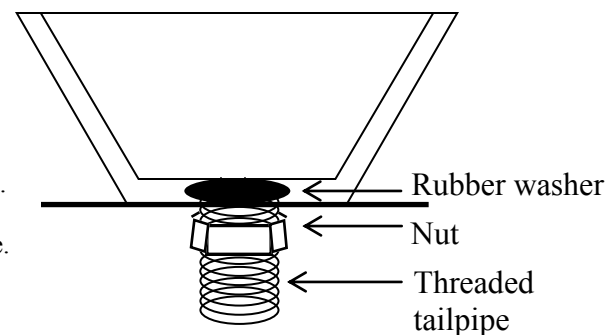

215 North 4<sup>th</sup> Street, Jeannette, PA 15644 ph:724.523.5567 fax:724.523.0123 [www.jsgoceana.com](http://www.jsgoceana.com)

Made in the U.S.A.