

LEGACY SERIES  
SHOWER STALL

Oasis®



42 INCH MODEL

SH-4240

Rough-In Dimensions

42" wide x 41-1/4" deep x 72-1/4" high (w/ 3-inch dam)

Finished Dimensions

42" wide x 40" deep x 71" high (w/ 3-inch dam)

Unit Features



- One - Piece Fiberglass Composite Construction
- Sanitary Grade Polyester Gelcoat Surface
- 3-3/8" Dia. Center Drain (see reverse side for location)
- Elevated Back Wall Shelves
- Flat Wall Design To Accommodate Grab Bar & Seat Applications
- Low Profile Dam (standard)
- Textured Floor Pattern
- Balsa Wood Core Floor Structure

Special Notes

- Optional ABF Model (provides 3 Inches of drain clearance)
- Factory Applied Reinforcement Packages Available
- Factory Applied Bar Only and Bar & Seat Packages Available

Order No.: SH-4240 (4" dam)

SH-4240 ABF (6" dam)

42" x 40", one-piece gelcoated fiberglass shower stall with a 3" low profile dam (1" drain clearance), dual upper shelves and lower accessory ledge, wall surround, and center drain.

SH-4240 ABF (illustrated)

	Std Unit	ABF Unit
A	72-1/4"	74-1/4"
B	71"	73"
C	3"	5"
D	1"	3"
E	-	-
F	-	-

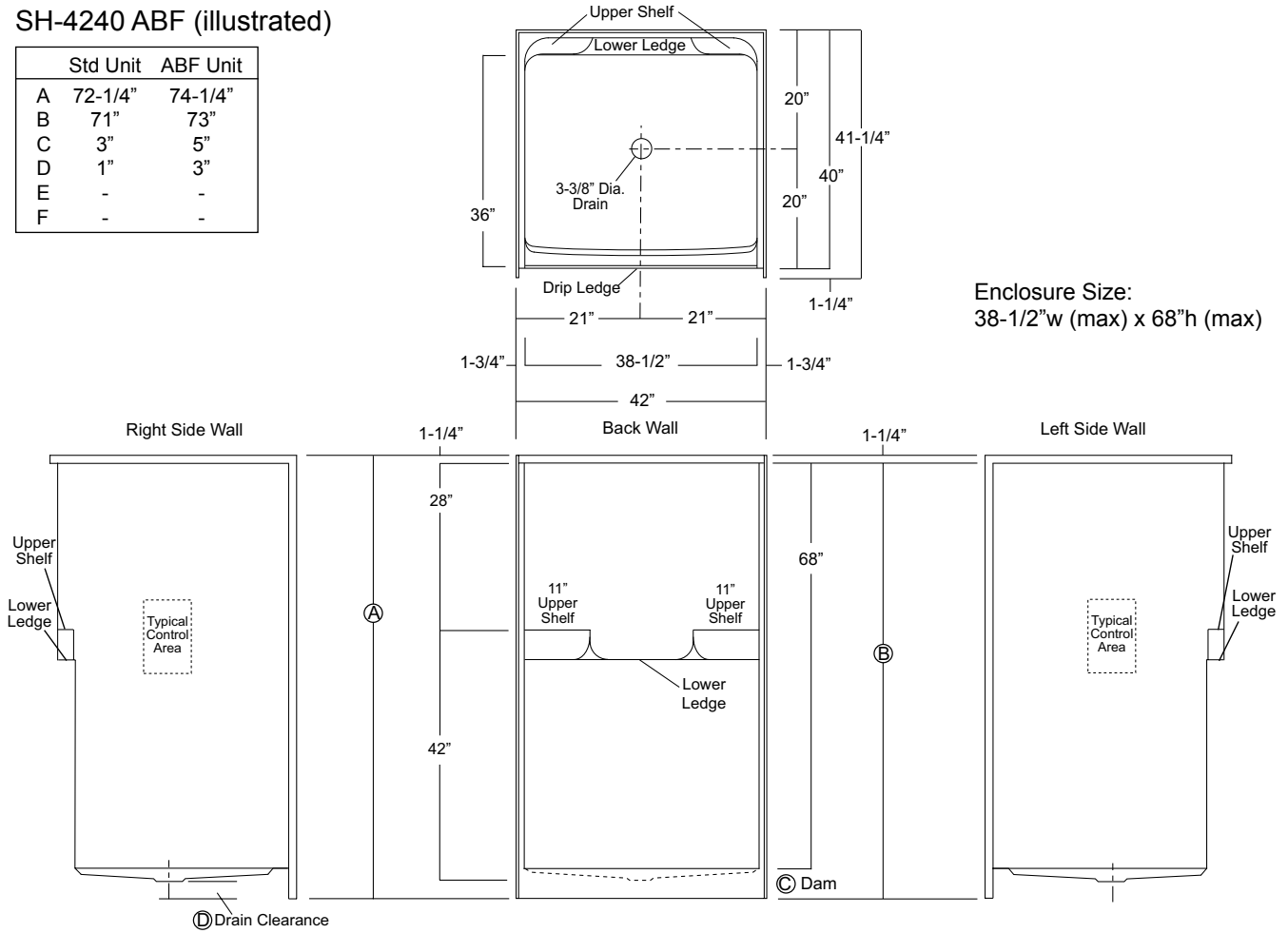

**Package Order No.: FH (Fair Housing wall reinforcement)**

Package Includes: Factory applied, HUD-FHA compliant (Fair Housing), structurally reinforced wall areas (as shown) for independent field application of bars.

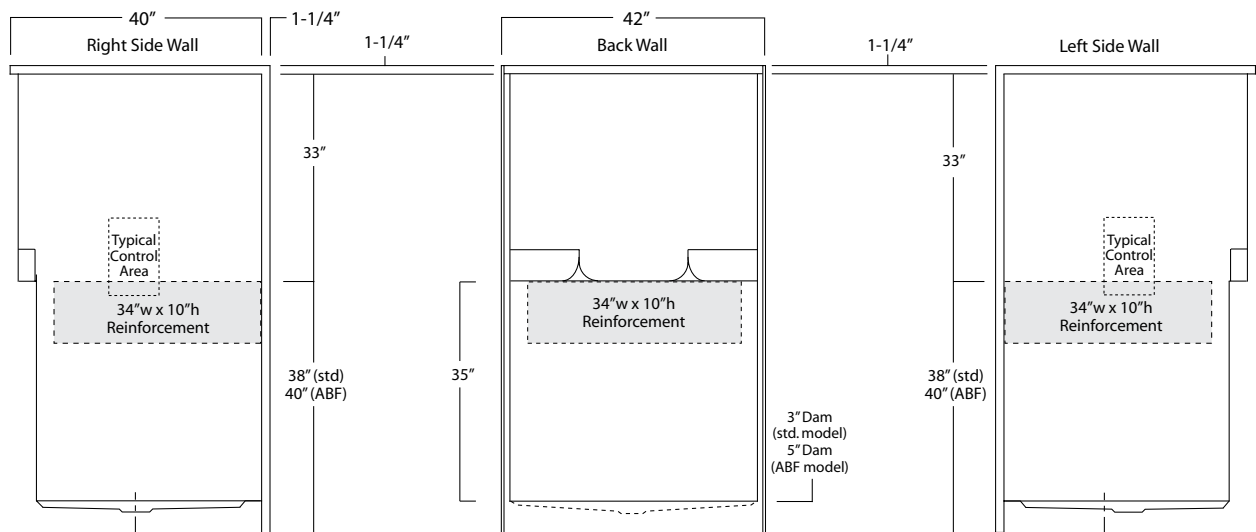

**Package Order No.: FHV (Fair Housing wall reinforcement)**

Package Includes: Factory applied, HUD-FHA compliant (Fair Housing), structurally reinforced wall areas (as shown) for independent field application of bars..

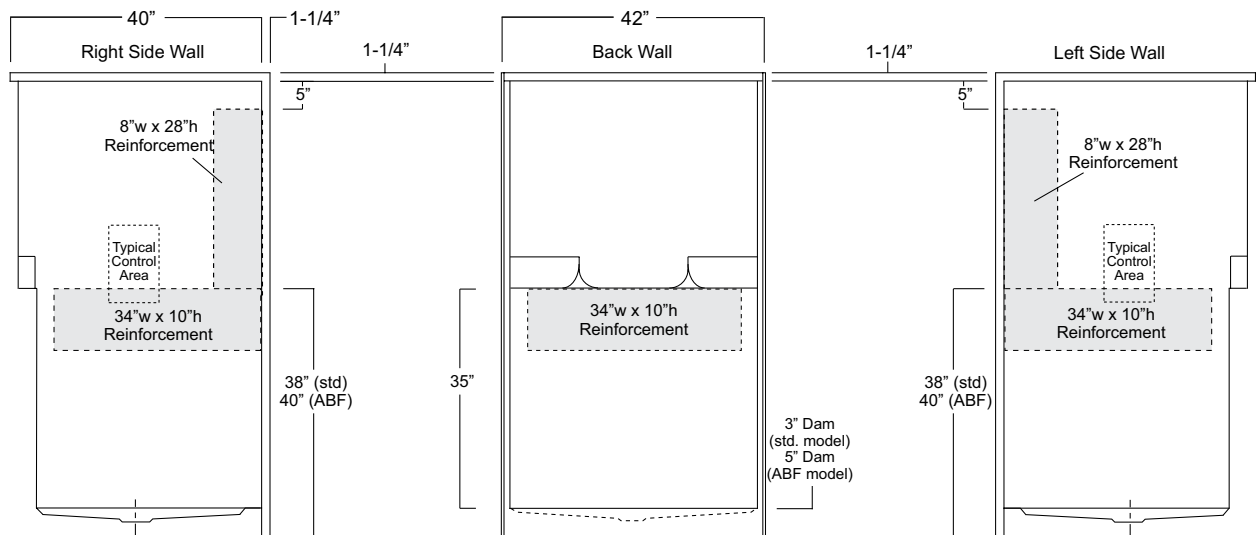

**Package Order No.: 3SM (3-side, mid-level wall reinforcement)**

Package Includes: Factory applied, 3-side, mid-level, structurally reinforced wall areas (as shown), exceeding 'Fair Housing' (HUD/FHA) requirements, for independent field application of bars.

NOTE: Factory installed component packages available with listed reinforcement.

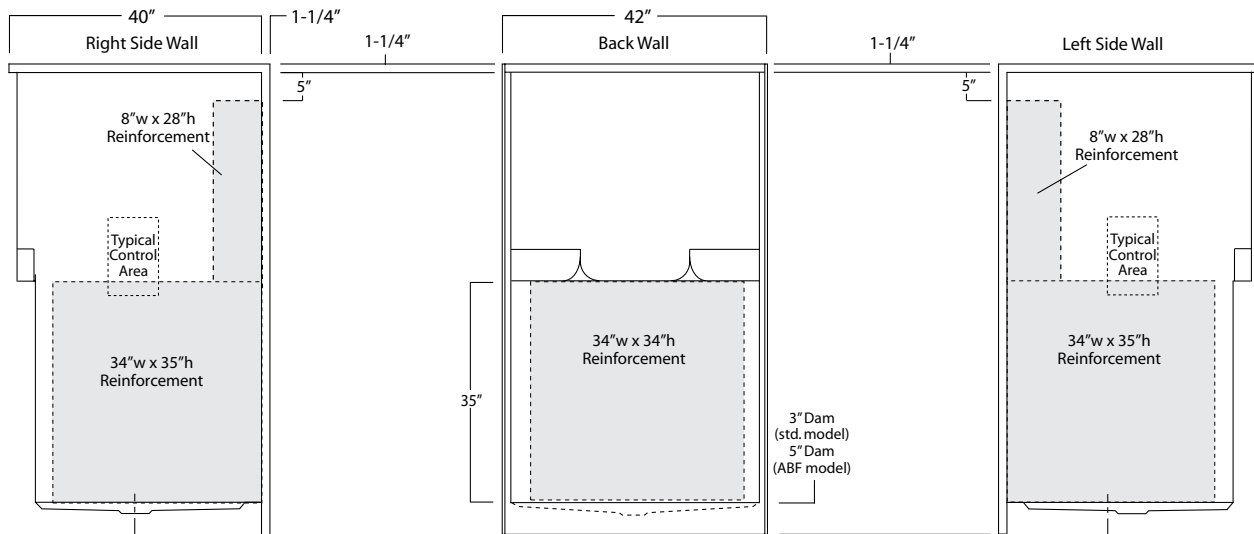

**Package Order No.: 3SF (3-side, full-wall reinforcement)**

Package Includes: Factory applied, 3-side, full-wrap, structurally reinforced wall areas (as shown), exceeding 'Fair Housing' (HUD/FHA) requirements, for independent field application of bars.

NOTE: Factory installed component packages available with listed reinforcement.

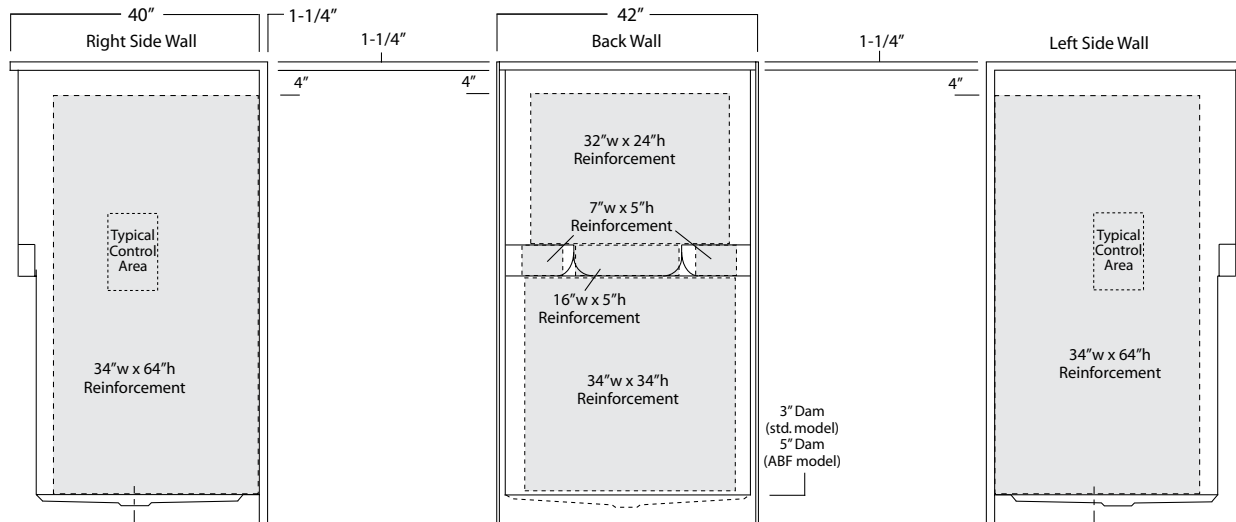

**Package Order No.:** BP1-(R or L) (2-bar only package)  
**Upgrade Package No.:** BP1-(R or L) WHT (1-1/4" dia., white powder coat, 2-bar only package)

Package Includes: Factory installed, 1-1/2" dia. stainless steel, 2-bar package with basic reinforcement for components (as shown).  
NOTES: Positioning of factory installed components allow for the installation of a shower enclosure.

"R or L" designates RH or LH control wall.

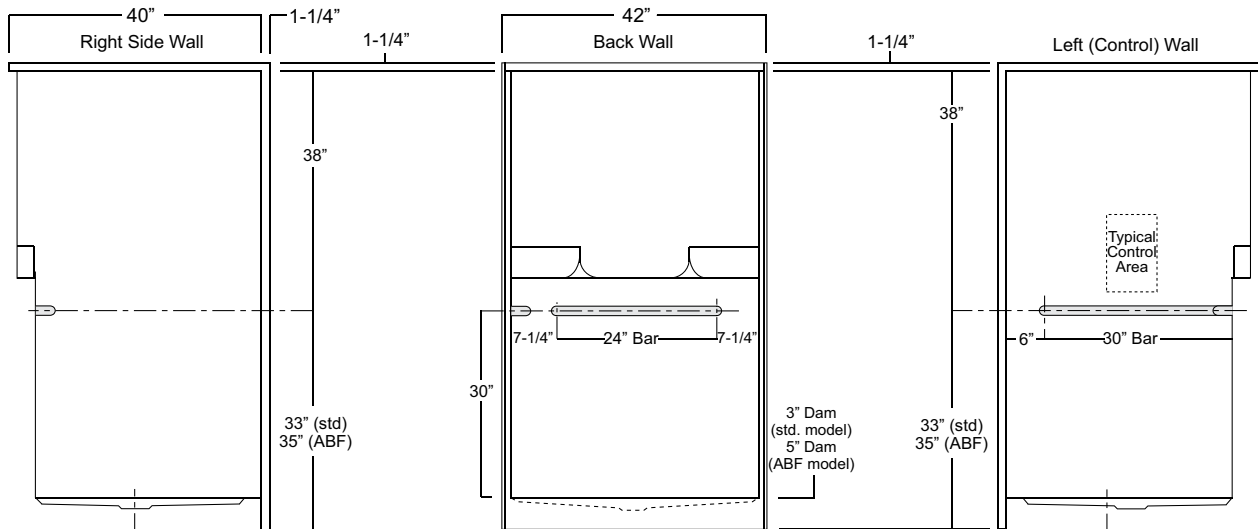

**Package Order No.:** BP2-(R or L) (3-bar only package)  
**Upgrade Package No.:** BP2-(R or L) WHT (1-1/4" dia., white powder coat, 3-bar only package)

Package Includes: Factory installed, 1-1/2" dia. stainless steel, 3-bar package with basic reinforcement for components (as shown).  
NOTES: Positioning of factory installed components allow for the installation of a shower enclosure.

"R or L" designates RH or LH control wall.

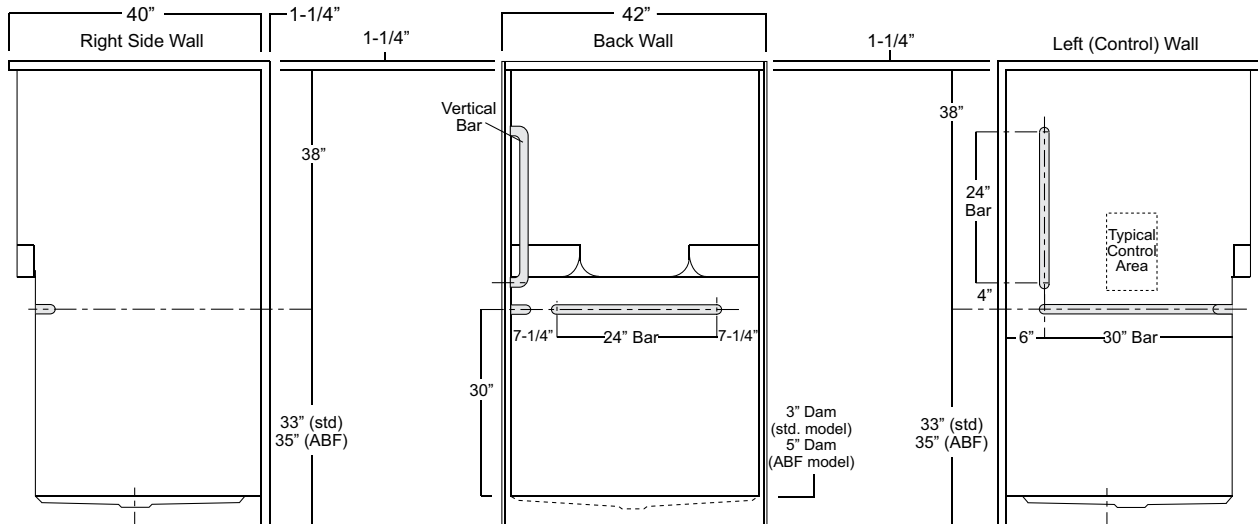

Package Order No.: **BP5 (single-bar only package)**  
 Upgrade Package No.: **BP5 WHT (1-1/4" dia., white powder coat, single-bar only package)**

Package Includes: Factory installed, 1-1/2" dia. stainless steel, single, back wall bar package (as shown).

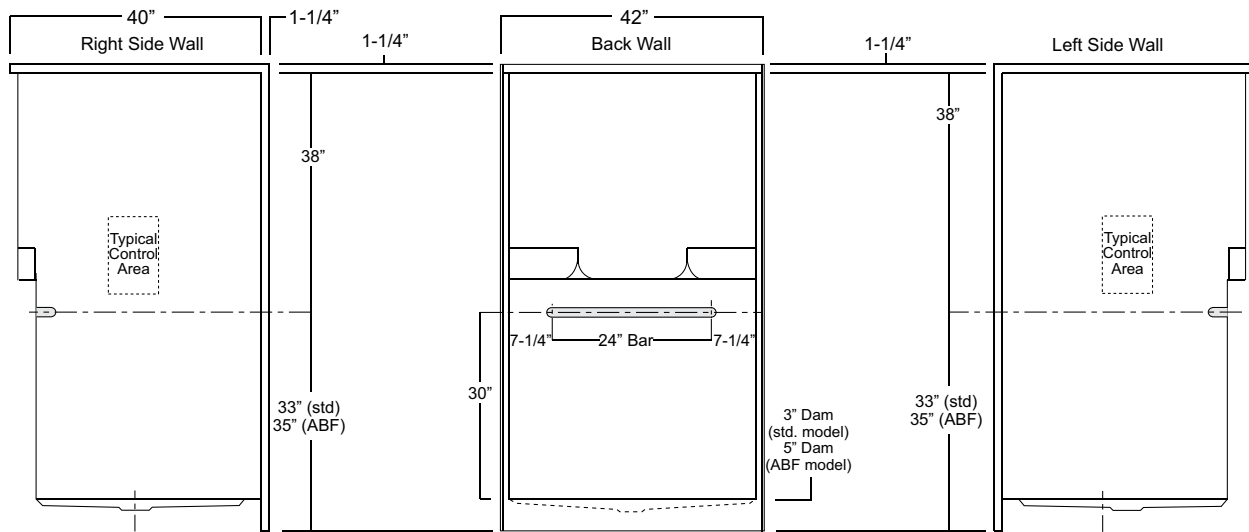

Package Order No.: **TL-(RS or LS) (2-bar & folding seat package)**  
 Upgrade Package No.: **TL-(RS or LS) WHT (1-1/4" dia., white powder coat, 2-bar & folding seat package)**

Package Includes: Factory installed, 1-1/2" dia. stainless steel, 2-bar and folding seat package with basic reinforcement for components (as shown).

NOTES: Positioning of factory installed components allow for the installation of a shower enclosure.  
 "RS or LS" designates seat wall.

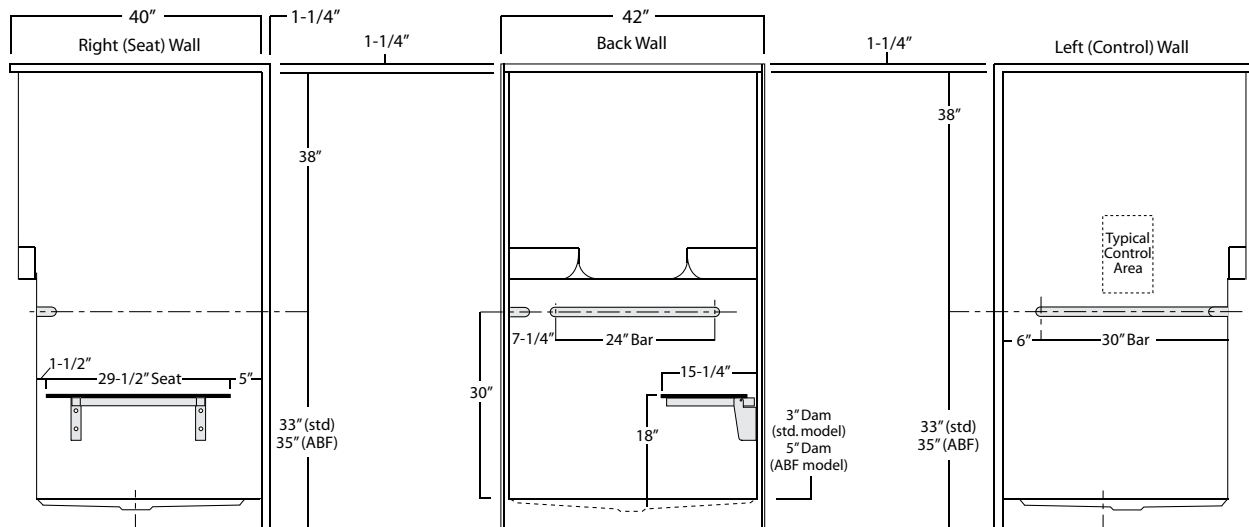

Package Order No.: TLV-(RS or LS) (3-bar & folding seat package)

Upgrade Package No.: TLV-(RS or LS) WHT (1-1/4" dia., white powder coat, 3-bar & folding seat package)

Package Includes: Factory installed, 1-1/2" dia. stainless steel, 3-bar and folding seat package with basic reinforcement for components (as shown).

NOTES: Positioning of factory installed components allow for the installation of a shower enclosure.

"RS or LS" designates seat wall.

