

# ZALEMA 3260 AFR

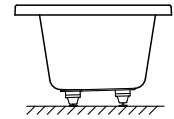

60" x 32" x 20 5/8" [50 gallons]

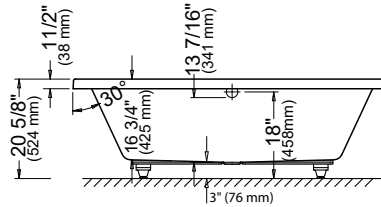
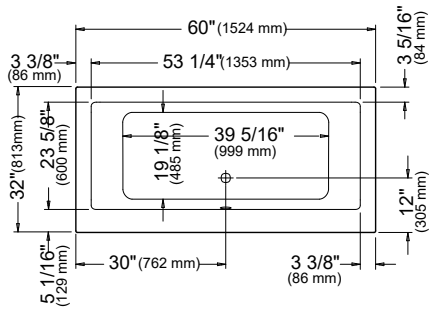

## GENERAL SPECIFICATIONS

- Acrylic thermoformed and reinforced with fiberglass
- Gloss finish resistant to stains and discoloration
- Immersion 13 3/16" - Adjustable legs
- Weight: 60 pounds - Central drain

## GENERAL OPTIONS

Acrylic colors: white  
biscuit\* or bone\* (allow 3 weeks for delivery)

White mood light: white, biscuit, bone or chrome finish

Handle: white, biscuit, bone or chrome finish 95.7077.106.XX  
(max. 2) (submit drawing with order)

Drain D105 (20"): chrome finish 62.4020.102.60

Black neck pillow (12" x 4") 18.6000.100.20

## WHIRLPOOL OPTIONS

Finish for Whirlpool jets: white, biscuit or bone  
Other: chrome

Inline heater 110 V

## ACTIV-AIR OPTIONS

Finish for Activ-Air jets: white, biscuit or bone  
Other: chrome

Blower hose extension 36" 95.5013.116.00

Blower hose extension 72" 95.5013.167.00

Blower hose extension 96" 95.5013.168.00

Blower extensions are necessary when the blower is located more than 4' from the pneumatic control.

DIMENSIONS ARE NOMINAL AND MAY VARY BY ± 1/4" (6MM).  
WEIGHT MAY VARY BY ± 5 LBS (2,3KG).  
DRAWING IS NOT SCALE. THESE DIMENSIONS MAY BE CHANGED AT THE MANUFACTURER'S DISCRETION.  
CONSULT THE INSTALLATION GUIDE FOR MORE INFORMATION.

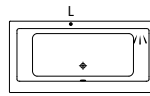

Bathtub only

E10.21012.0000

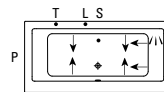

Whirlpool

E15.21012.000030

Included: 6 round jets, two air controls, one 7.5 A (120 V) pump and one pneumatic control.

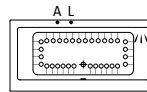

Activ-Air

E15.21012.000010

Included: 32 Activ-Air micro-jets, one blower 9.5 A (120 V) with heating element (200 W) and one pneumatic control.

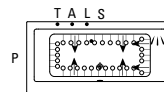

Whirlpool/Activ-Air combo

E15.21012.000031

Included: 6 round jets, 31 Activ-Air micro-jets, two air controls, one 7.5 A (120 V) pump, one blower 9.5 A (120 V) with heating element (200 W) and two pneumatic controls.

- ➔ : Whirlpool jets
- : Activ-Air jets
- S : Suction
- T : Whirlpool control
- A : Activ-Air control
- P : Pump
- L : Light control
- ≡ : Mood light (option)

Note: The blower is never installed.



COMPLIANCE ATTESTATION  
Standard bathtubs  
CAN / CSA.B45.5  
Hydromassage Standards  
CAN / CSA.B45.10 / CSA.C22.2 / UL-1795



Certification ECORESPONSIBLE  
First manufacturer of bathroom products in North America to be certified ecoresponsible.



Produits Neptune

ENTREPRENEUR

6835, Picard street, Saint-Hyacinthe (Quebec) J2S 1H3  
Phone: (450) 773-7058 - Fax: (450) 773-5063  
produitsneptune.com



Produits Neptune

## ZALEMA 3260 AFR

DROP-IN

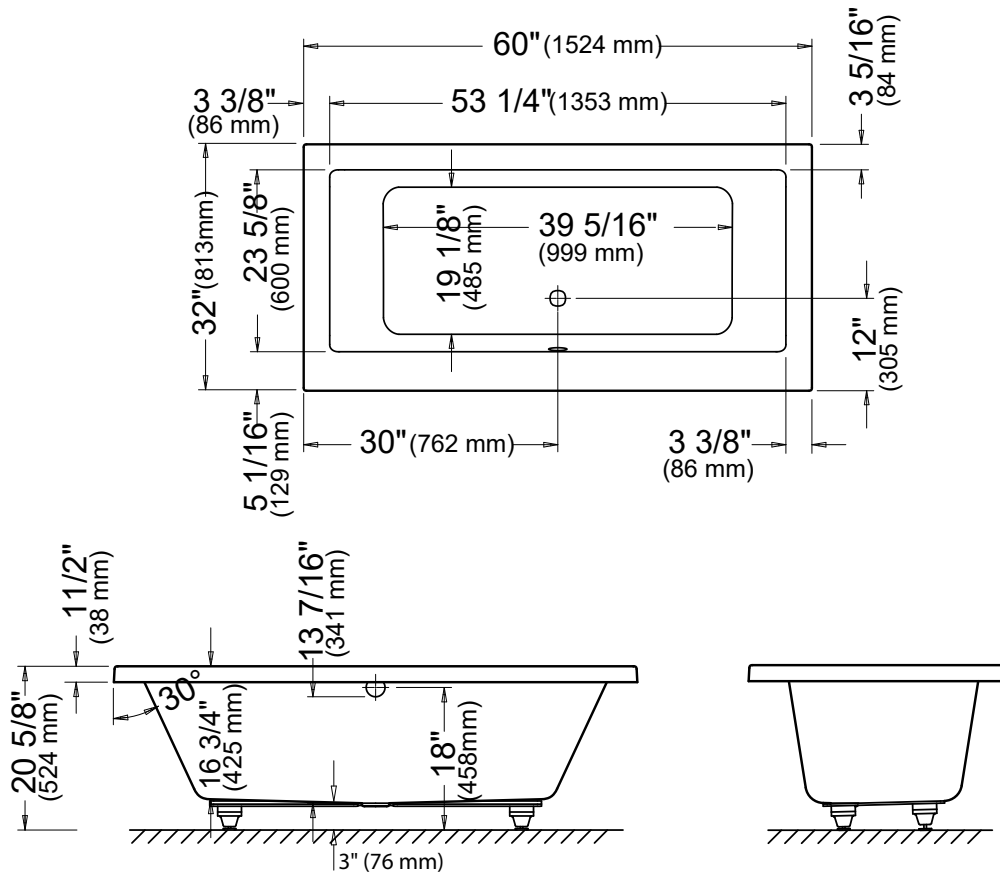

\*All dimensions are approximate and subject to change without notice.  
Please refer to the installation guide before beginning the installation.