

CHESTERFIELD

Prep Sink / Bar Faucet

938



Features

- Solid brass construction
- Forged brass body with integral rotating spout and handles
- Quarter-turn washerless ceramic disc valve cartridges
- ADA compliant traditional cross handles
- Rotating spout assembly with integral supply hoses
- 5.23" (13.3 cm) spout height at outlet
- 6.95" (17.7 cm) spout reach (c-c)
- For single hole configurations
- ADA Compliant
- 1.8 GPM (6.8 LPM) Max

Codes / Standards Compliance

Meets or exceeds the following at date of manufacture:

- ASME A112.18.1/CSA B125.1
- IAMPO/cUPC
- NSF/ANSI 61, SECTION 9
- NSF/ANSI 372
- IPC
- ADA & ICC/ANSI A117.1
- Energy Policy Act of 1992
- California Energy Commission
- All applicable US Federal and State material regulations

Colors / Finishes

- 10B: Oil Rubbed Bronze
- 15: Polished Nickel
- 15S: Satin Nickel - PVD
- 26: Polished Chrome
- Other: Refer to the Newport Brass catalog for additional color/finish options.



Specified Model

Model	Description	Colors Finishes
938	Two-Handle Prep Sink / Bar Faucet	<input type="checkbox"/> 10B <input type="checkbox"/> 15 <input type="checkbox"/> 15S <input type="checkbox"/> 26 <input type="checkbox"/> Other

Product Specification Add "Color / Finish" suffix to Model number, below.

The Two-Handle Prep Sink / Bar Faucet shall be made of solid brass construction. Faucet shall feature a forged brass body incorporating quarter-turn washerless ceramic disc valve cartridges. Faucet shall have a 1.8 gallon (6.8 liter) per minute maximum flow rate. Product shall accommodate single hole configurations. Product shall incorporate a 5.23" (13.3 cm) spout height at outlet and a 6.95" (17.7 cm) spout reach (c-c). Faucet shall incorporate ADA compliant traditional cross handles. Prep Sink / Bar Faucet shall be Newport Brass Model 938/_____.

938

PRODUCT DIMENSIONS *(Units are in inches)*

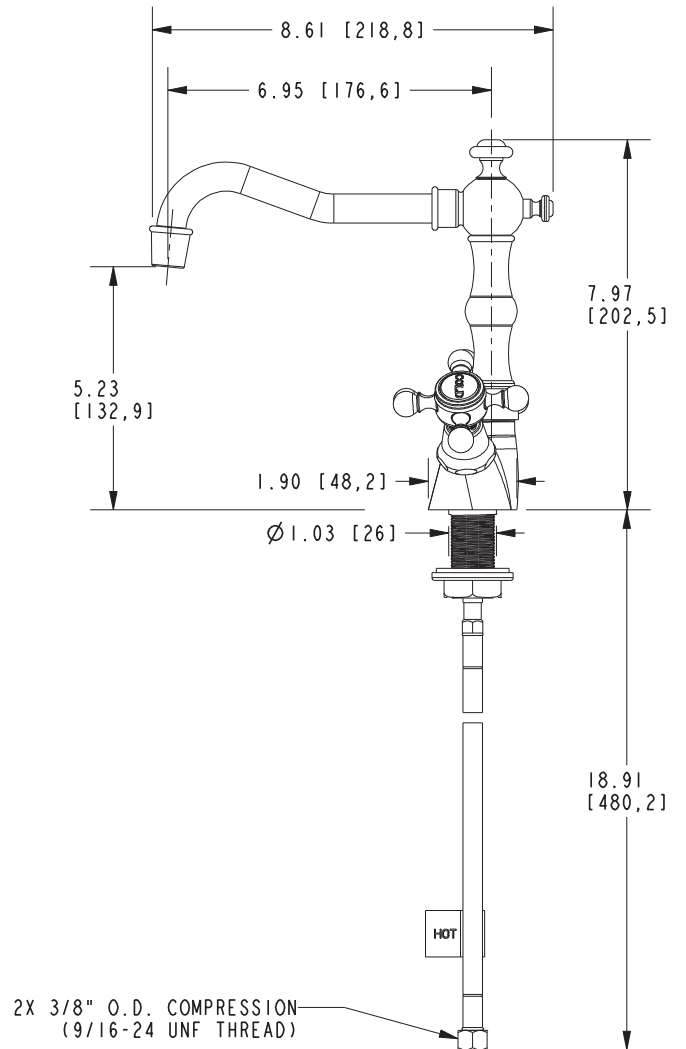
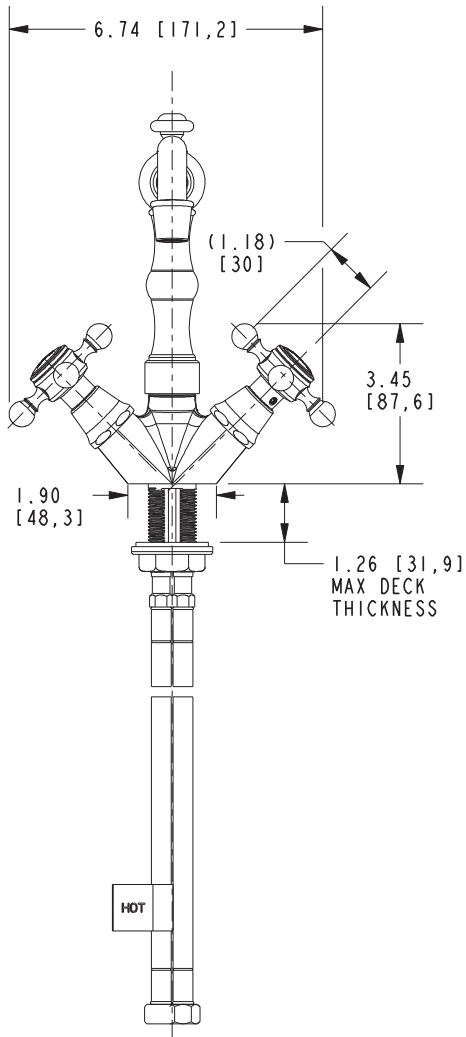

Chesterfield Prep Sink / Bar Faucet 938