

Features

Solid brass construction
Forged brass body with top-mounted handle
Euro-motion ceramic disc 25 mm valve cartridge
Spout assembly with integral supply hoses
Push pop-up drain with tailpiece
4.31" (10.9 cm) spout height at outlet
6.19" (15.7 cm) spout reach (c-c)
For single hole configurations
ADA Compliant
1.2 GPM (4.5 LPM) Max

Single Hole Lavatory Faucet

3233



Codes / Standards Compliance

Meets or exceeds the following at date of manufacture:

ASME A112.18.1/CSA B125.1
IAPMO/cUPC
NSF/ANSI/CAN 61, SECTION 9
NSF/ANSI 372
IPC
ADA & ICC/ANSI A117.1
Energy Policy Act of 1992
EPA WaterSense
California Energy Commission
All applicable US Federal and State material regulations

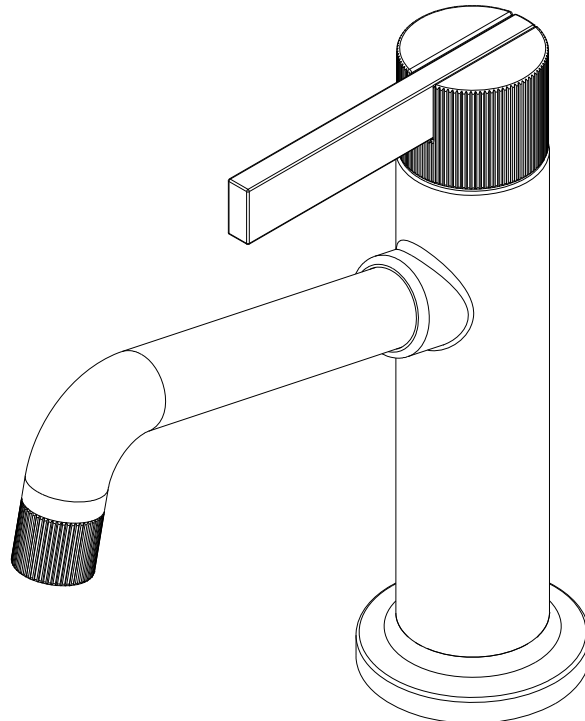

3233

PRODUCT DIMENSIONS *(Units are in inches)*

Product Dimensions are provided for reference only. For specific product installation guidelines, please reference the Installation Instructions of the product being installed.

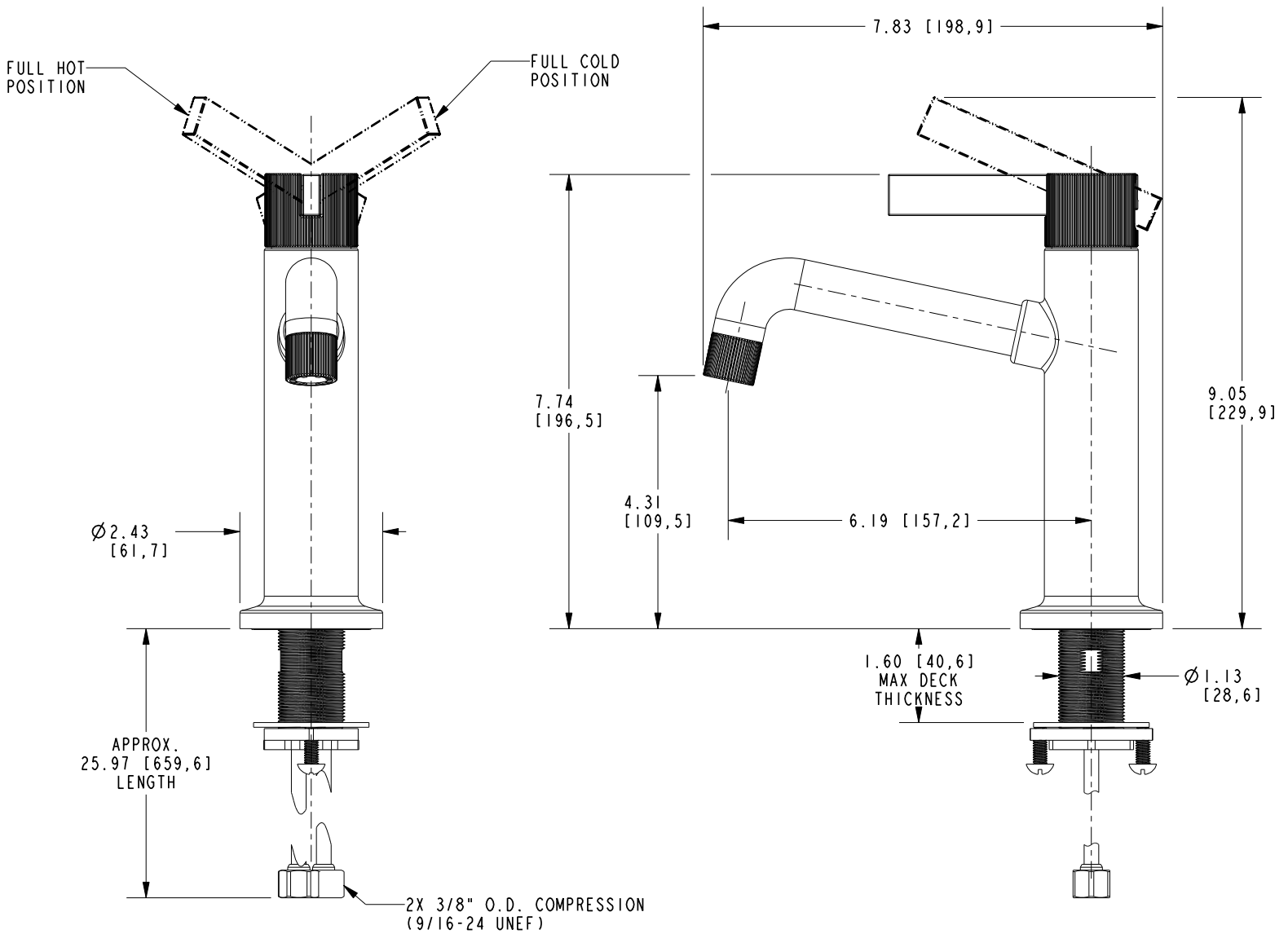

Single Hole Lavatory Faucet

3233

Page 2 of 2
EN- 4816
REVB

NEWPORT BRASS
Flawless Beauty. From Faucet to Finish.

t: 949.417.5207 | www.newportbrass.com
©2024 Brasstech, Inc.