

BADEN F1 3266

66 3/4" x 31 1/2" x 23"



PRODUCT DESCRIPTION:

Adjustable feet
Contemporary style
Above-the-floor rough (AFR)
Integrated linear overflow and drain kit included, chrome

24-48hrs
5 days

WATER CAPACITY:

277 L

IMMERSION:

15 1/8 po

BOX SIZE:

68 1/2" x 33 1/16" x 23 13/16"

NET WEIGHT:

47.8 kg

GROSS WEIGHT:

57.7 kg

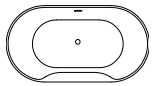
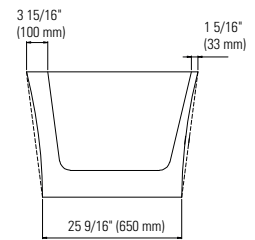
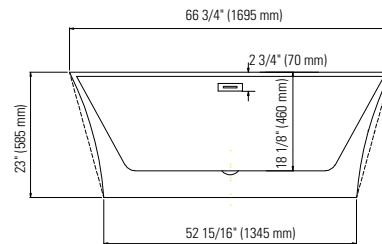
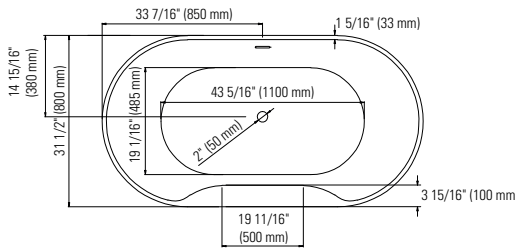

Bathtub only

BAD3266F1

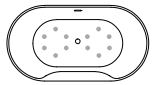

Mass-Air

BAD3266F1M

Included: 12 injectors, 750W (1 1/2h.p.) Optima blower, with 300W heating element, 72" blower hose extension, and remote control.



Rouge-Air

BAD3266F1A

Included: 12 micro-jets, 750W (1 1/2h.p.) Optima blower, with 300W heating element, 72" blower hose extension, and remote control.

GENERAL OPTIONS

Overflow and waste included: Chrome

Acrylic Colour: White

Standard

Bathtub drain adapter (picture below)

Gel black neck pillow

White, brushed nickel or black overflow and drain kit

MASS-AIR / ROUGE-AIR OPTIONS

Mass-Air Jet finish: White/Chrome

Standard

Others: Chrome/Chrome

96" blower hose extension

A blower hose extension is required when the blower is located more than 4' from the bathtub.

BATHTUB DRAIN ADAPTER

123Connect is a freestanding bathtub rough-in (install before tile).

- Quick, easy and clean installation.
- No access panel required.
- Allows for an installation as close to the wall as possible.

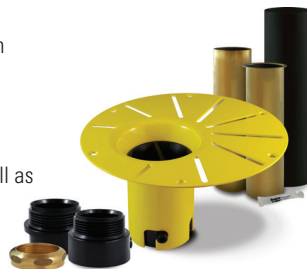

LINEAR OVERFLOW



White



Brushed nickel



Chrome



Black



CONFORMITY ATTESTATION
Bathtub Standards
cUPC
Hydromassage Standard
CAN / CSA.B45.10 / CSA.C22.2 / UL-1795



ECORESPONSABLE Certification
First manufacturer of bathroom products in North America to be certified ecoresponsible



Produits Neptune
Rouge

6835, Picard street, Saint-Hyacinthe (Québec) J2S 1H3
Phone: (450) 773-7058 - produitsneptune.com



Produits Neptune
Rouge

Baden 3266 F1

Bathtub

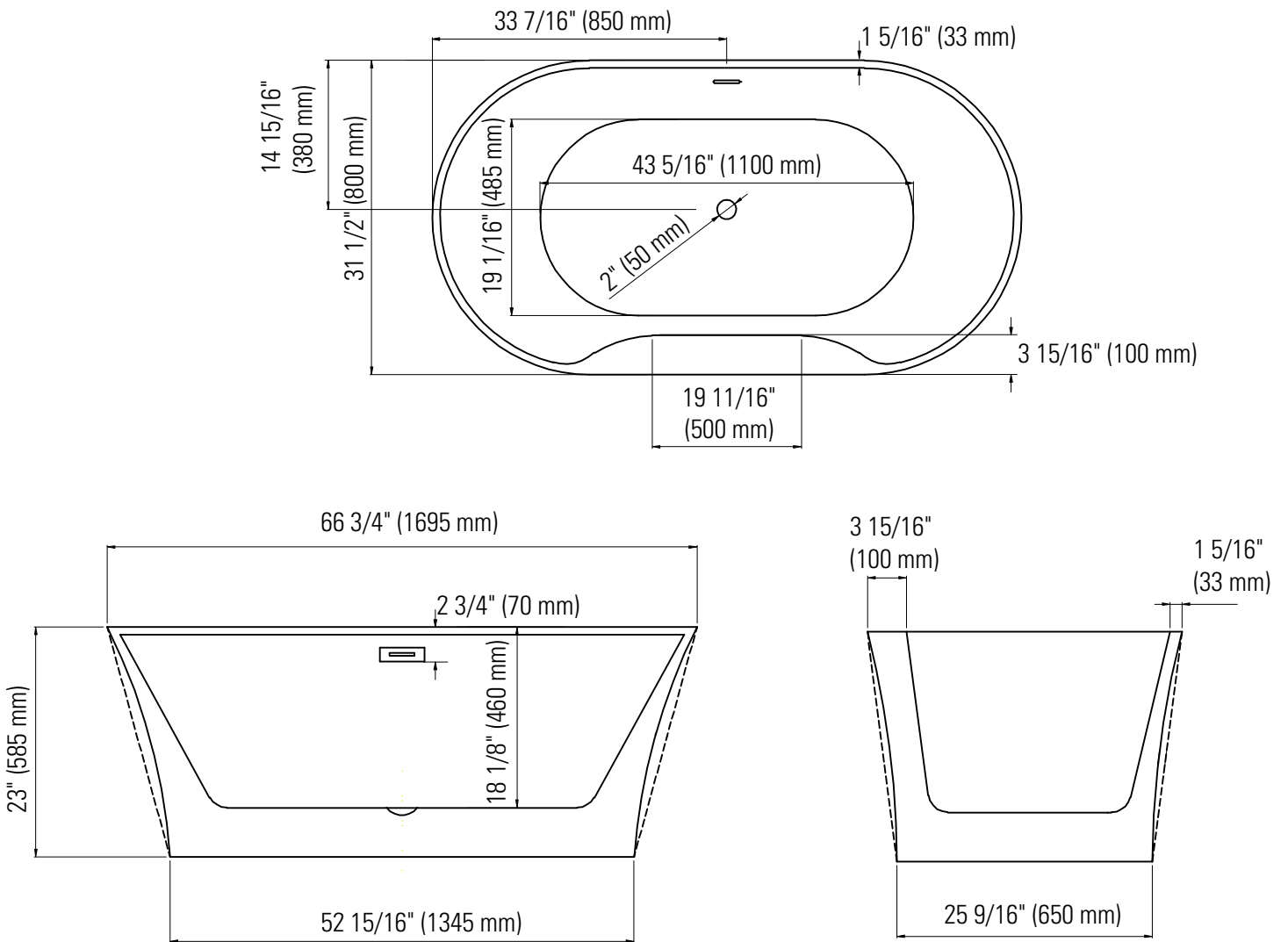

Ajustable feet

Above-the-floor rough (AFR)

*All dimensions are approximate and subject to change without notice
Please refer to the installation guide before beginning the installation