

71 7/8" x 35 3/4" x 24"



## GENERAL OPTIONS

**Acrylic Colors:** White Standard  
 Biscuit\*, Bone\* (Allow 3 weeks delivery)  
 Others\*: (Allow 6 to 8 weeks delivery)

**Chromotherapy 1 light** (Specify trim color) 17.99999.0000.00

**Chromotherapy 2 lights** (Specify trim color) 17.99999.0001.00

**Chromotherapy 4 lights** (Specify trim color) 17.99999.0002.00

**Handle** (1) (centered overflow's opposite side) 95.7077.106.XX

**D105 Waste** (20") Chrome 62.4020.102.60

**Gel Neck Pillow** (12" x 4 1/4 x 1 1/4") 18.6000.100.20

**Rayola\*\*** (Specify control color)

## WHIRLPOOL OPTIONS

**A bathtub fitted with back jets may cause the pump to protrude by +/- 3" from the overall dimension.**

**Pump is located behind seat** (right side)

**Whirlpool Jet finish:** White, Biscuit, Bone, Chrome Standard

**110v Inline Heater** (1)

## MASS-AIR/ACTIV-AIR OPTIONS

**Mass-Air Jet finish:** White/Chrome Standard  
 Biscuit/Chrome  
 Bone/Chrome

**Others:** Chrome/Chrome

**Activ-Air Jet finish:** Chrome, White, Biscuit, Bone Standard

**Blower Hose extension 72"** 95.5013.167.00

**Blower Hose extension 96"** 95.5013.168.00

**144" Extension cord** 95.3012.101.00

**An extension cord and blower hose extension are necessary when the blower is located more than 2' from the electronic control, not available on whirlpool combos.**

\*Customized products, non cancellable, non returnable.

\*\*Not available with a neck pillow.

## PRODUCT DESCRIPTION:

Adjustable feet  
 Transitional style  
 Gloss finish resistant to stains and discoloration  
 Acrylic thermoformed and reinforced with fiberglass

5 days

## WATER CAPACITY:

79 gallons

## IMMERSION:

16 1/4 po

## BOX SIZE:

74" x 36 1/2" x 24 1/2"

## NET WEIGHT:

65 lbs

## GROSS WEIGHT:

84 lbs

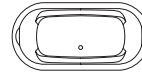

**Bathtub only**

**REV3672**

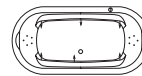

**Whirlpool**

**REV3672T**

Included: 6 turbo jets, 10 micro-rotating back jets, 13 A pump, two diverter valves and electronic control.

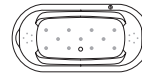

**Mass-Air**

**REV3672M**

Included: 21 (11-10) injectors, Optima blower 750W (1 1/2 h.p.) with 300W heating element and backlit electronic control.

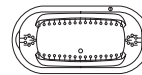

**Activ-Air**

**REV3672A**

Included: 48 micro-jets, Optima blower 750W (1 1/2 h.p.) with 300W heating element and backlit electronic control.

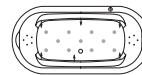

**Mass-Air/Whirlpool Combo**

**REV3672C**

Included: 6 turbo jets, 10 micro-rotating back jets, 11 Mass-Air injectors, 13 A pump, Optima blower 750W (1 1/2 h.p.) with 300W heating element, two diverter valves and backlit electronic control.

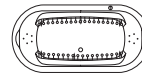

**Activ-Air/Whirlpool Combo**

**REV3672CA**

Included: 6 turbo jets, 10 micro-rotating back jets, 38 Activ-Air micro-jets, 13 A pump, Optima blower 750W (1 1/2 h.p.) with 300W heating element, two diverter valves and backlit electronic control.

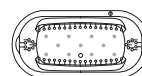

**Mass-Air/Activ-Air Combo**

**REV3672CMA**

Included: 48 Activ-Air micro-jets, 11 Mass-Air injectors, two Optima blowers 750W (1 1/2 h.p.) with 300W heating element and backlit electronic control.

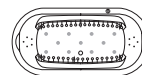

**Activ-Air/Mass-Air/Whirlpool Combo**

**REV3672TAM**

Included: 6 turbo jets, 10 micro-rotating back jets, 38 Activ-Air micro-jets, 11 Mass-Air injectors, 13 A pump, two Optima blowers 750W (1 1/2 h.p.) with 300W heating element, two diverter valves and backlit electronic control.



**Intertek**

**COMPLIANCE ATTESTATION**  
 Standard bathtubs  
 CAN / CSA.B45.5  
 Hydromassage Standards  
 CAN / CSA.B45.10 / CSA.C22.2 / UL-1795



**Certification ECORESPONSIBLE**  
 First manufacturer of bathroom products in North America to be certified ecoresponsible.



**Produits Neptune**

6835, Picard street, Saint-Hyacinthe (Quebec) J2S 1H3  
 Phone: (450) 773-7058 - produitsneptune.com

REV: 01-21



Produits Neptune

# REVELATION 3672

## Bathtub

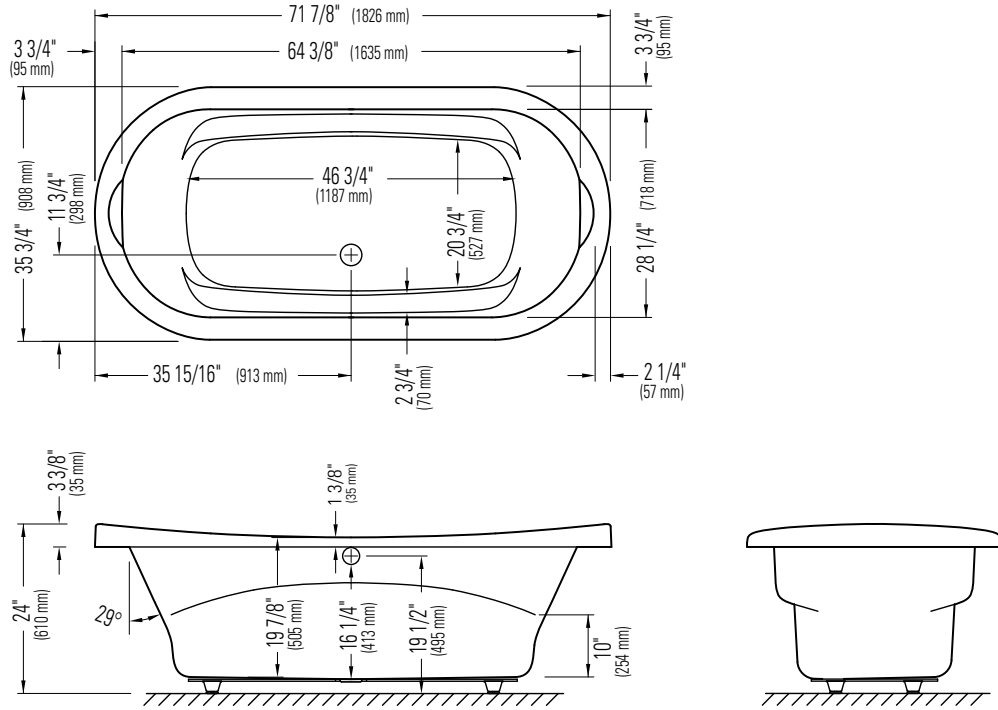

\*A bathtub fitted with back jets can cause the pump to protrude by approximately 3" from the overall dimension.

\*\*All dimensions are approximate and subject to change without notice. Please refer to the installation guide before beginning the installation