

BELIEVE 3672

71 7/8" x 35 7/8" x 23 1/2"



PRODUCT DESCRIPTION:

Adjustable feet
 Transitional style
 Gloss finish resistant to stains and discoloration
 Acrylic thermoformed and reinforced with fiberglass

5 days

WATER CAPACITY: 85 gallons	IMMERSION: 17 1/2 po
BOX SIZE: 72 1/2" x 36 1/2" x 24"	
NET WEIGHT: 64 lbs	GROSS WEIGHT: 83 lbs

GENERAL OPTIONS

Acrylic Colors: White Biscuit* and Bone* (Allow 3 weeks delivery) Others*: (Allow 6 to 8 weeks delivery)	Standard
Chromotherapy 1 light (Specify trim color)	17.99999.0000.00
Chromotherapy 2 lights (Specify trim color)	17.99999.0001.00
Chromotherapy 4 lights (Specify trim color)	17.99999.0002.00
Tiling Flange (submit drawing with order)	
Handle (1) (centered overflow's opposite side)	95.7077.106.XX
D105 Waste (20") Chrome	62.4020.102.60
Gel black neck pillow (12"x 4 1/4 x 1 1/4")	18.6000.100.20
Rayola** (Specify control color)	

WHIRLPOOL OPTIONS

A bathtub fitted with back jets may cause the pump to protrude by +/- 3" from the overall dimension.
Pump is located behind seat (right side)

Whirlpool Jet finish: Chrome, White, Biscuit, Bone	Standard
110v Inline Heater (1)	

MASS-AIR/ACTIV-AIR OPTIONS

Mass-Air Jet finish: White/Chrome Biscuit/Chrome Bone/Chrome	Standard
Others: Chrome/Chrome	
Activ-Air Jet finish: Chrome, White, Biscuit, Bone	Standard
Blower Hose extension 72"	95.5013.167.00
Blower Hose extension 96"	95.5013.168.00
144" Extension cord	95.3012.101.00

An extension cord and blower hose extension are necessary when the blower is located more than 2' from the electronic control, not available on whirlpool combos.

*Customized products, non cancellable, non returnable.
 **Not available with a neck pillow.

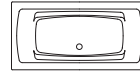

Bathtub only

BE3672

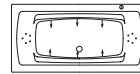

Whirlpool

BE3672T

Included: 6 turbo jets, 10 micro-rotating back jets, 13 A pump, two diverter valves and electronic control.

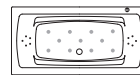

Mass-Air

BE3672M

Included: 21 (11-10) injectors, Optima blower 750W (1 1/2 h.p.) with 300W heating element and backlit electronic control.

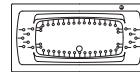

Activ-Air

BE3672A

Included: 52 micro-jets, Optima blower 750W (1 1/2 h.p.) with 300W heating element and backlit electronic control.

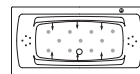

Mass-Air/Whirlpool Combo

BE3672C

Included: 6 turbo jets, 10 micro-rotating back jets, 11 Mass-Air injectors, 13 A pump, Optima blower 750W (1 1/2 h.p.) with 300W heating element, two diverter valves and backlit electronic control.

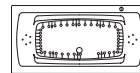

Activ-Air/Whirlpool Combo

BE3672CA

Included: 6 turbo jets, 10 micro-rotating back jets, 40 Activ-Air micro-jets, 13 A pump, Optima blower 750W (1 1/2 h.p.) with 300W heating element, two diverter valves and backlit electronic control.

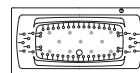

Mass-Air/Activ-Air Combo

BE3672CMA

Included: 52 Activ-Air micro-jets, 11 Mass-Air injectors, two Optima blowers 750W (1 1/2 h.p.) with 300W heating element and backlit electronic control.

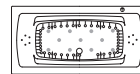

Activ-Air/Mass-Air/Whirlpool Combo

BE3672TAM

Included: 6 turbo jets, 10 micro-rotating back jets, 40 Activ-Air micro-jets, 11 Mass-Air injectors, 13 A pump, two Optima blowers 750W (1 1/2 h.p.) with 300W heating element, two diverter valves and backlit electronic control.



COMPLIANCE ATTESTATION
 Standard bathtubs
 CAN / CSA.B45.5
 Hydromassage Standards
 CAN / CSA.B45.10 / CSA.C22.2 / UL-1795



Certification ECORESPONSIBLE
 First manufacturer of bathroom products in North America to be certified ecoresponsible.



Produits Neptune

6835, Picard street, Saint-Hyacinthe (Quebec) J2S 1H3
 Phone: (450) 773-7058 - produitsneptune.com

REV: 01-21



Produits Neptune

BELIEVE 3672

Bathtub

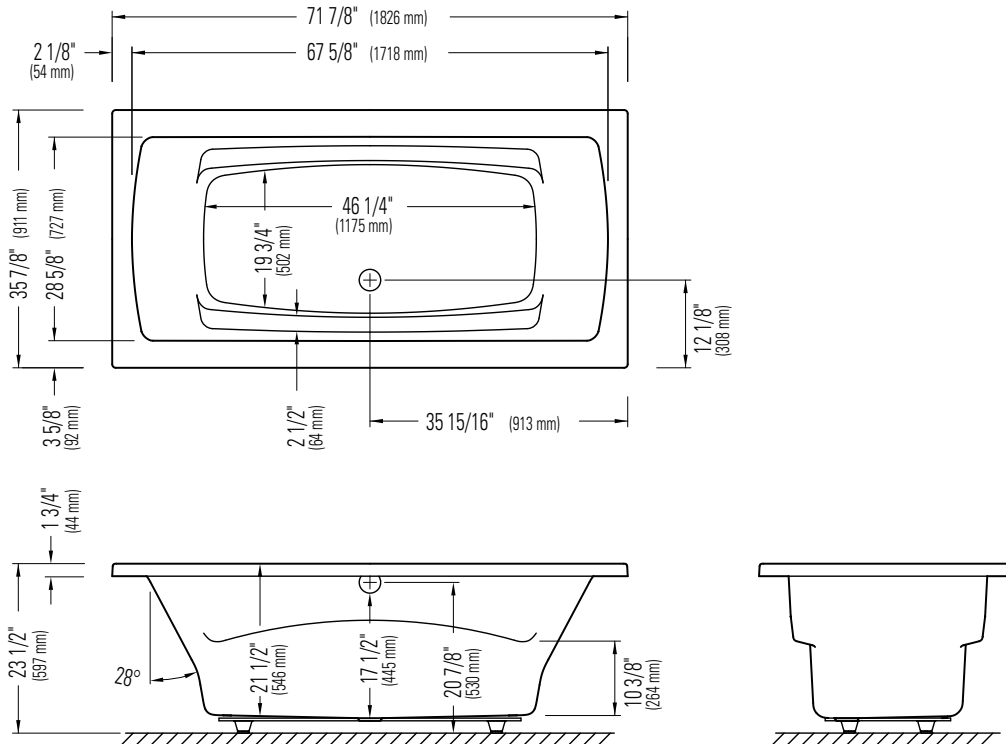

*A bathtub fitted with back jets can cause the pump to protrude by approximately 3" from the overall dimension.

**All dimensions are approximate and subject to change without notice. Please refer to the installation guide before beginning the installation