

## STANDARD

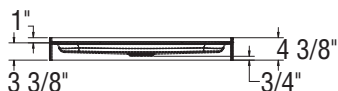

## RENFORCEMENT

OPTION 20198 PRÉSENTÉ  
OPTION 20197 SYMÉTRIQUE

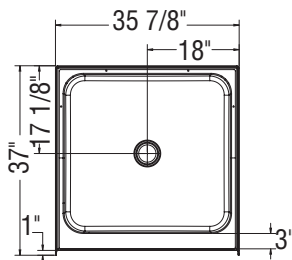
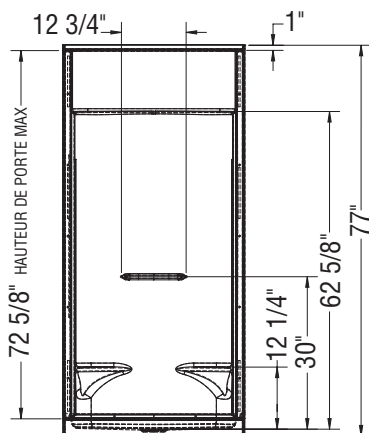
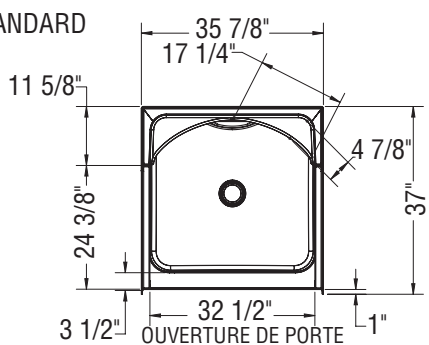
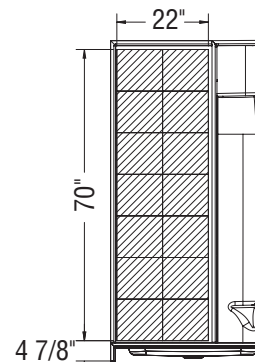

OPTION 20199

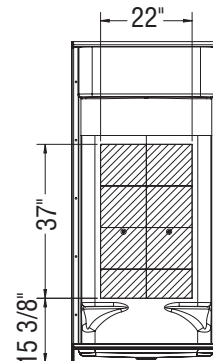

## BARRES D'APPUI

OPTION 20203

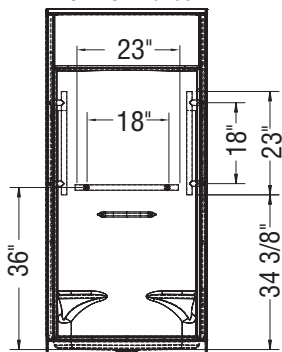

OPTION 20204

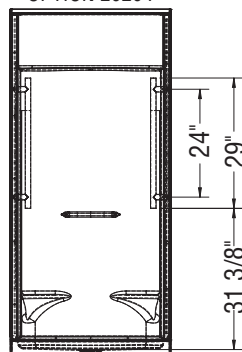

OPTION  
20203-20204

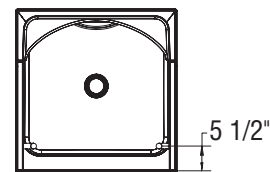

Toutes ces dimensions sont approximatives. Afin d'assurer une installation parfaite, les dimensions de la structure doivent être vérifiées à partir de l'unité.  
\* Les dimensions indiquées sur les pages produits excluent les brides de carrelage.