

MT666-3CFWD3B

**PERFECT GRIND®
CONTINUOUS FEED 3/4 HP
FOOD WASTE DISPOSER**

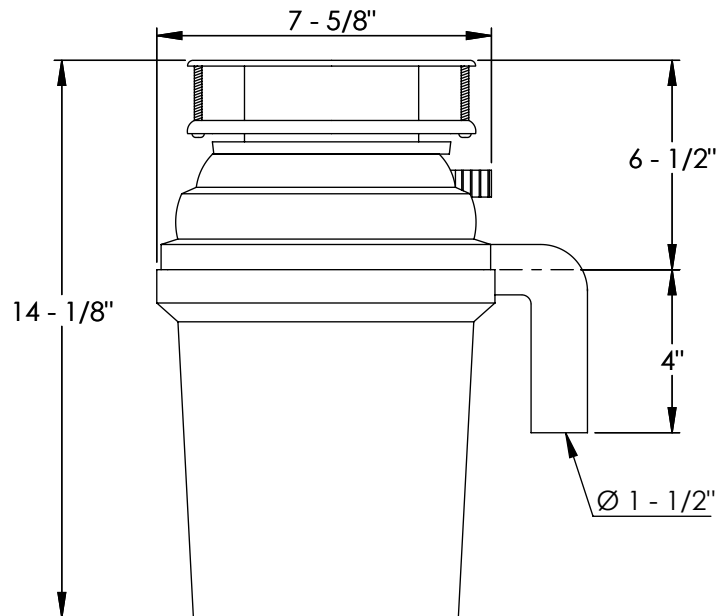

A McAlpine Company
Mountain
Plumbing Products



This model offers the following features:

- Permanent Magnet High RPM Means High Torque and Fewer Jams
- Bio-guard Antimicrobial Protection
- Removable Splash Guard
- Stainless Steel Turntable and Grind Rings (Compared to Competitor's Cold-Rolled or Galvanized Steel)
- Factory Installed Power Cord with Plug
- Safe for Properly Sized Septic Tanks
- 3-Bolt Mounting System
- Full Sound Insulation for Quiet Operation

SPECIFICATIONS

HP	3/4
Motor Type	Permanent Magnet
Feed	Continuous
Volts	110V
Frequency	50/60 Hz
Motor Speed	2500 RPM
Hopper Capacity	29 oz
Balance Level	G 0.4
Turntable	Stainless Steel
Grind Rings	Stainless Steel
Sink Flange	Stainless Steel
Basket Strainer	Stainless Steel
Drain Elbow	ABS
Bearings	Permanently Lubricated, Sleeve Type
Manual Reset Protector	Protection for Overload and Temp.
Shipping Weight	13 lbs
Pallet Quantity	64 pcs

WARRANTY

THE 3/4 HP MOUNTAIN PERFECT GRIND WASTE DISPOSER COMES WITH A LIFETIME REPLACEMENT WARRANTY AGAINST ANY MECHANICAL OR MATERIAL DEFECT. IN ADDITION TO THE ABOVE WARRANTY, ALL PERFECT GRIND DISPOSERS COME WITH A LIFETIME WARRANTY AGAINST CORROSION. LABOR NOT INCLUDED.