

MONOGRAM 30" BUILT-IN ADVANTIUM® 120 ZSB9131NSS

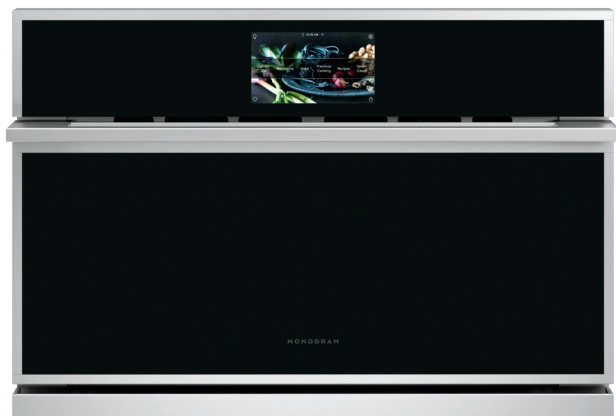

THE MONOGRAM MINIMALIST COLLECTION

Streamlined design and precisely machined metals create a contemporary yet functional aesthetic

5-IN-1-OVEN

Experience exceptional flexibility and cooking results with this innovative five-in-one oven. Advantium® Technology enhanced, it can be used as a convection oven, toaster oven, warming/proofing oven, precision cook oven, and microwave

POWERFUL PERFORMANCE

Oven-quality foods cook up to four times faster than a conventional oven, with no preheating required

SPEEDCOOK TECHNOLOGY

Offering the ultimate in cooking speed and flexibility, the halogen-lighting system combines with microwave technology to Speedcook favorite foods to perfection in minutes, with no preheating

SPACIOUS INTERIOR

Generous, 1.7-cu.-ft oven space with a large 16" turntable allows for full rotation of a 9" x 13" casserole dish; plus the removable oven rack offers the convenience of multi-level cooking

PREPROGRAMMED RECIPES

Provide quick and easy programming of over 175 pre-set food selections and allows programming of up to 30 custom recipes

INSTALLATION FLEXIBILITY

Ovens can be installed in 30" wall cabinet and can also be installed undercounter

LCD CONTROLS

Allow you to adjust oven settings with little effort

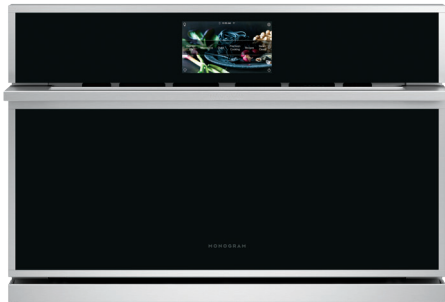

SPECIFICATIONS

Overall Width	29 3/4" (75.6 cm)
Overall Height	20 1/4" (51.4 cm)
Overall Depth	23" (58.4 cm)
Oven Door Clearance	13 1/4" (33.65 cm)
Overall Oven Interior Capacity	1.7 cu. ft.
Oven Interior Dimensions (W x H x D)	20 1/16" x 8 1/2" x 17" (51 cm x 21.6 cm x 43.2 cm)
Minimum Cabinet Width	30" (76.2 cm)
Minimum Cabinet Depth	21 1/2" (54.6 cm)
Minimum Base Support	130 lbs (59 kg)
Cutout Width	25 1/4" (64.1 cm)
Cutout Height	17 1/2" (44.5 cm)
Cutout Depth	21 1/2" (54.6 cm) Min
Volt/Hertz/Amps	120 VAC, 60 Hz, 15 Amps
Conduit Length	48 1/2" (123.2 cm)
Electrical Rating	1.8 kW at 120V
Total Amps	15 amps
Shipping Weight	92 lbs (41.7 kg)

ATTENTION ELECTRICIAN:

A 120V, 60Hz, 15 Amp circuit is required. An individual properly grounded branch circuit or circuit breaker is required. Hardware junction box is required for built-in product.

OVERALL DIMENSIONS

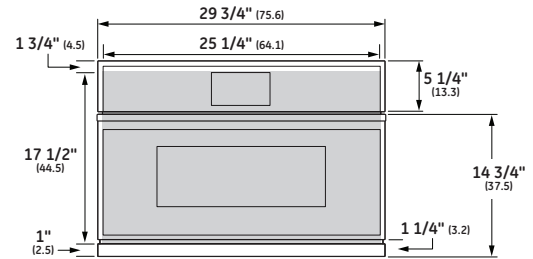

FRONT VIEW (SHOWING CUTOUT OVERLAP)

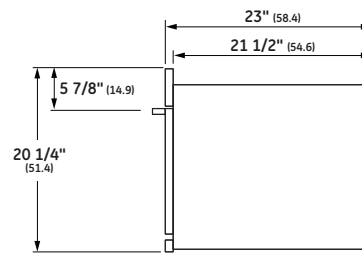

SIDE VIEW

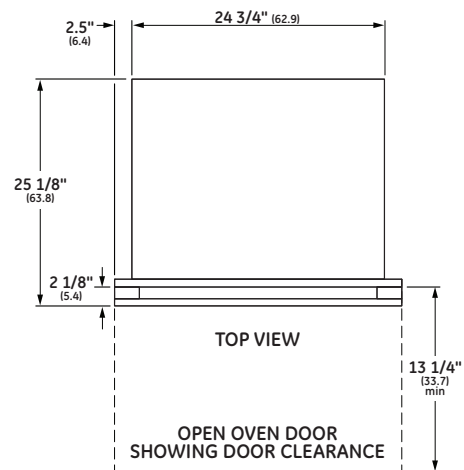

TOP VIEW

Dimensions in parentheses are in centimeters unless otherwise noted. Actual product dimensions may vary due to manufacturing tolerances.

WALL INSTALLATION

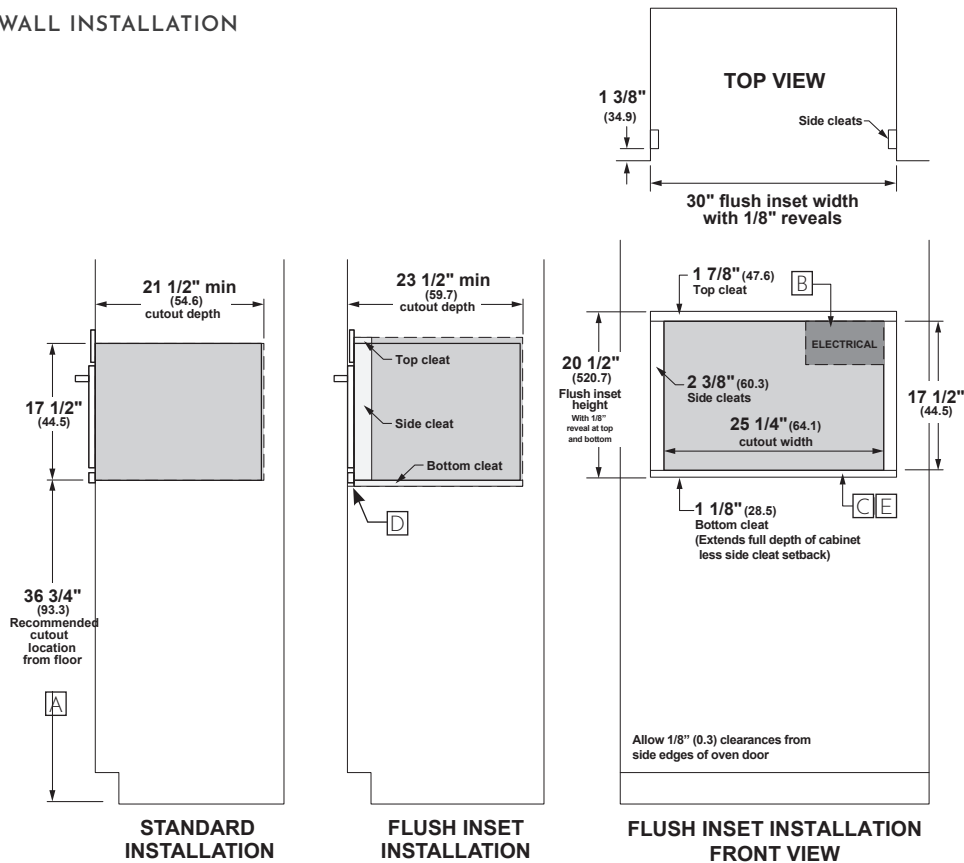

HELPFUL TIPS

- A Based on a user height of 5' 6" to 5' 10"
- B Junction box location (May also be located in adjacent cabinet.)
- C Platform must be able to support 130 lbs (59 kg)
- D Top surface of cabinet must be an appearance finished surface for flush installation.
- E Cleats may be visible and should be finished to match cabinetry.
- F Maximum toe kick height of 4" when installed beneath a certified cooktop.

UNDERCOUNTER INSTALLATION

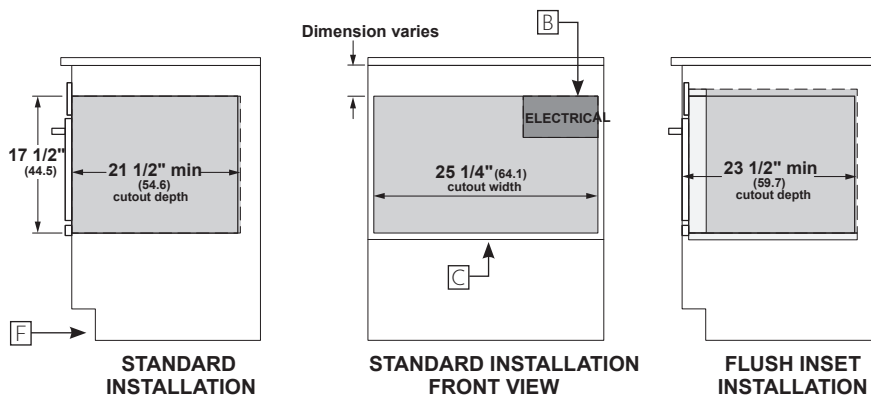

For more details, refer to the installation instructions for this product on Monogram.com. Dimensions in parentheses are in centimeters unless otherwise noted.