

DESCRIPTION

- Brass construction with chrome plated finish
- 140° restricted swing with 100° adapter

FLOW

- Aerator is limited to 2.2 gpm MAX. (8.34 L/min)

STANDARDS

- Complies with California Proposition 65 and with the Federal Safe Water Drinking Act

WARRANTY

- Warranted for 5 years against material or manufacturing defects

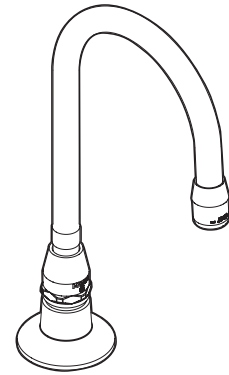

Restricted Swing Spout Kit

Model: S00R30

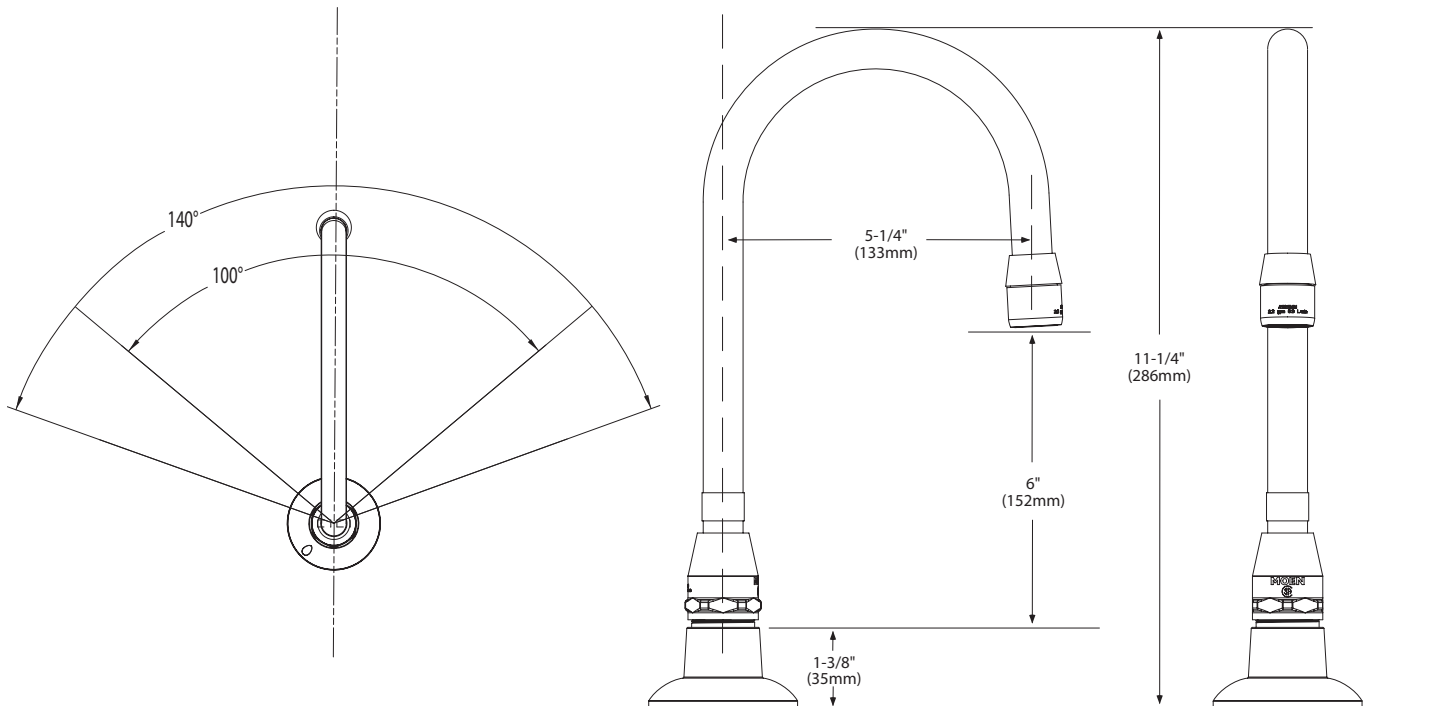

CRITICAL DIMENSIONS

(DO NOT SCALE)