

Disposal Description

- GX Pro is part of the Moen Disposal Prep™ Series: designed for basic meal prep and cleanup. Packs all the standard features and reliable performance in a more compact form.
- 1/2 Horsepower VORTEX™ Motor has powerful grinding for everyday kitchen scraps. Motor technology designed to help reduce jamming
- Universal Xpress Mount™ fits all Moen and most existing 3-bolt mounting assemblies
- Pre-installed power cord - a savings over models where cord must be purchased separately, cord easily removes for optional hardwiring
- Ultra compact design frees up space under the sink
- Continuous feed with galvanized steel grind components
- Manual Reset Button
- Garbage disposals reduce waste sent to landfills making it an eco-friendly option for your home

Included Components

- GXP50c Disposal Unit with Universal Xpress Mount™
- Pre-installed Power Cord, Hardwire Capable
- Removable Splash Guard
- Drain Stopper and Polished Stainless Steel Sink Flange
- Drain Elbow and Mounting Assembly

Warranty & Assurance

- 5 year limited warranty with in-home service
- Safe for use with properly sized septic systems

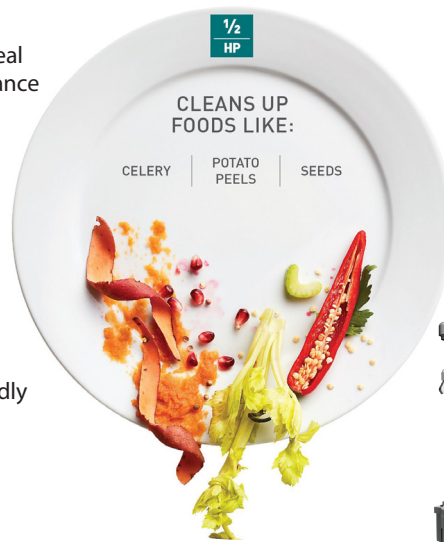

Model: GXP50c



Critical Dimensions

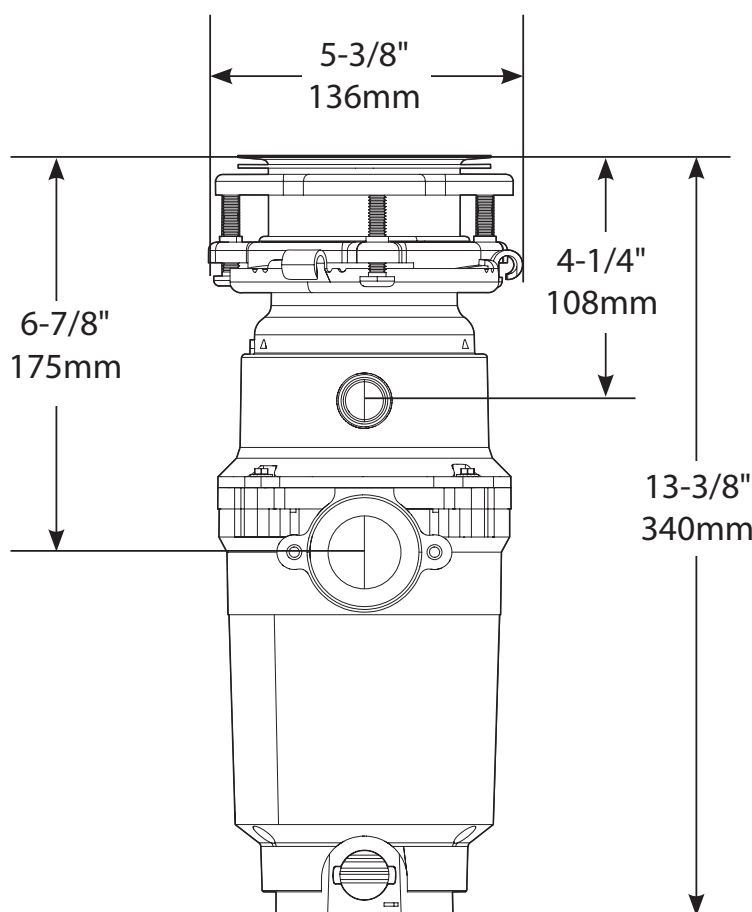

Specification Detail	
Horsepower	1/2 HP
Feed Type	Continuous
On/Off Controls	Wall Switch
Motor Type	Permanent Magnet Motor
RPM (Revolutions Per Minute)	1900
Weight	7.75 lbs. / 3.5 kg
Volts	115
Hz/Amps	60/4.5
Drain Connection Size	1 1/2" / 38mm
Dishwasher Connection Size	7/8" / 22mm
Maximum Sink Thickness	1/2" / 13mm
Sink Drain Flange Finish	Polished Stainless Steel
Grind Component Material	Galvanized Steel
Grind Chamber Material	Corrosion Proof Glass Filled Polyester and Nylon