

Models 6119/6118, 6119A/6118A, 6619/6618

PRO-FIT® 3660 TFS

Rectangular Whirlpool or Bathtub





Features

- 60" x 35-3/4" x 23" Rectangular alcove whirlpool or bathtub
- Integral apron and tile flange
- Six powerful Ultra-Swirl jets
- Dual air knobs for total jet control
- Limited One-Year Warranty
- Available in standard colors: white, almond, biscuit and bone





Model 6118
(Shown with trim upgrade and Lift and Turn drain)

Options

Lift and Turn Drain			Model #	Description	
PF1320	Polished Chrome		PF1330	Access Panel on Apron	
PF1321	Everbrass (PVD)				
PF1322	Brushed Nickel				
PF1323	Oil Rubbed Bronze				

Whirlpool Option

Metal Trim

Model #	Description		Model #	Description	
PF1335	Polished Chrome		SWP151	In-line Water Heater	
PF1336	Everbrass (PVD)				
PF1337	Brushed Nickel				
PF1338	Oil Rubbed Bronze				



MADE IN USA



Models 6119/6118, 6119A/6118A, 6619/6618

PRO-FIT® 3660 TFS

Rectangular Whirlpool or Bathtub



Specifications

Model #	Description	Codes/Standards
6119	60" x 35-3/4" x 23" TFS Lefthand rectangular whirlpool without panel	  
6119A	60" x 35-3/4" x 23" TFS Lefthand rectangular whirlpool with access panel	
6118	60" x 35-3/4" x 23" TFS Righthand rectangular whirlpool without panel	
6118A	60" x 35-3/4" x 23" TFS Righthand rectangular whirlpool with access panel	
6619	60" x 35-3/4" x 23" TFS Lefthand rectangular bath	
6618	60" x 35-3/4" x 23" TFS Righthand rectangular bath	

Specification	Description	Specification	Description
Material	Acrylic, fiberglass reinforced	Number of Jets	6
Construction	Self-contained, pre-plumbed whirlpool bath mounted on a pre-leveled base	Water Capacity	32 gal. (min.) / 45 gal. (max.)
Pump Motor	Single speed, 120 volt, 60 HZ, 5.8 amp, premounted	Floor Loading Weight	47 lbs. / sq. ft. (229 kg/m ²)
Electrical Requirements	120 volt, 15 AMP, GFCI protected circuit	Shipping Weight	whirlpool - 156 lbs. bathtub - 136 lbs.
On/Off Control	Air Switch	Warranty	Limited One Year

Technical Information

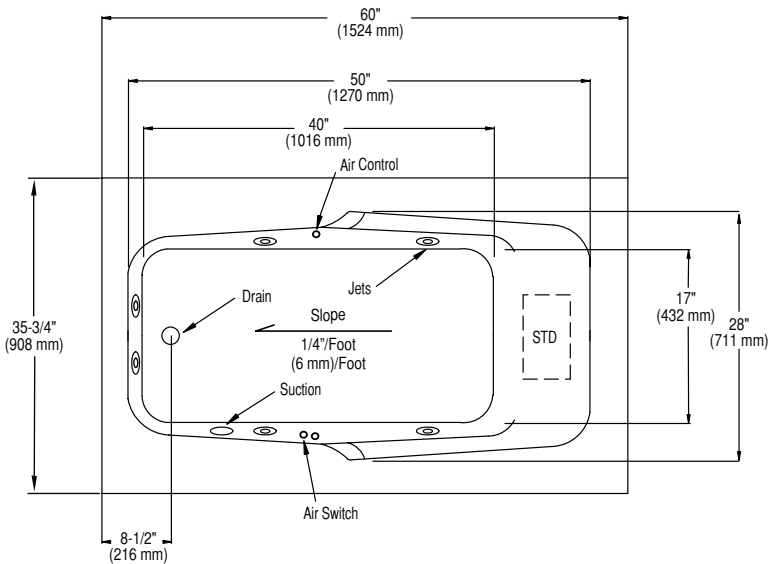

Optional Removable Apron

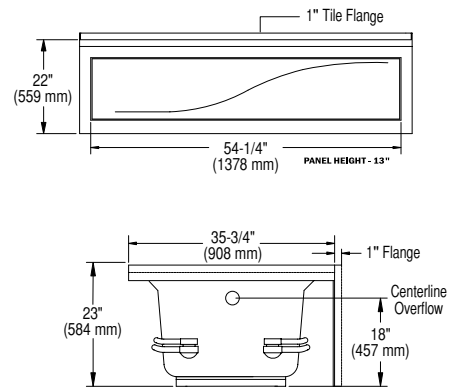

Pump locations are shown for clarity.
STD - standard pump location.

Notes: Measurements may vary 1/4" (+/-)

Install this product according to the installation guide.

These dimensions are nominal and subject to change without notice.

When tested for compliance to the requirements of ASME A112.19.7M for "Whirlpool Bath Appliances" and ANSI Z124.1.2M "American National Standard for Plastic Bathtub and Shower Units", the tested units are found to comply and are acceptable for listing under IAPMO R & T.

Certified for permanent electrical connection only.

Please visit our website to view IAPMO certification information – www.mansfieldplumbing.com



MADE IN USA