

4987-2987 VANQUISH® 1.28

MANSFIELD®

Elongated Front, SmartHeight™, Vitreous China, Two-Piece Toilet

FEATURES

- 1.28 gpf / 4.8 lpf low water consumption
- Revolutionary seat design with side-mount hinges for easy cleaning
- PuraClean® easy-to-clean glazed surface
- Elongated front, SmartHeight™ bowl
- 3' Rigid Flapper flush valve – requires less force to flush, is more consistent and uses a simple universal repair part/seal
- Fluidmaster® Pilot anti-siphon fill valve
- 12" rough-in
- SmartFasten™ 2-bolt tank-to-bowl connection
- Model 39 decorative metal trip lever
- 2" glazed trapway
- The Mansfield® limited lifetime warranty on china, Five-year limited warranty on tank trim & seat
- Available in white



MODEL 4987-2987

Toilet seat included

Available as CTK



CTK





ELONGATED



SMARTHEIGHT ADA

COMPONENTS

MODEL #	DESCRIPTION	CODES/STANDARDS
4987-2987	Elongated front, SmartHeight™, two-piece toilet. Less supply.	  
4987	Elongated front, SmartHeight™ bowl with side-mount seat.	
2987	Tank and lid only. With left hand, chrome-plated metal trip lever. Less supply.	
SB4000	Patented slow close seat with side-mount hinges*	

TANK TRIM & REPLACEMENT PARTS

39	Trip Lever - chrome-plated metal trip lever, left hand
400A	Fluidmaster® Pilot anti-siphon fill valve
2206	Pilot operated fill valve
2987-1112	3' Rigid Flapper flush valve
630-0030	Replacement flush valve seal
3987-LID	Tank Lid

*U.S. Patent No. 9809967





4987-2987 VANQUISH[®] 1.28



Elongated Front, SmartHeight™, Vitreous China, Two-Piece Toilet

SPECIFICATIONS

MODEL #	DESCRIPTION	CODES/STANDARDS
4987-2987	Elongated front, SmartHeight™ (1.28 gpf/4.8 lpf) two-piece toilet	  
MATERIAL	Vitreous China	
WATER PRESSURE RANGE	20 to 80 PSI	
FLUSH SYSTEM	SmartFlush™ Flushing Technology	
WATER USAGE	1.28 gpf / 4.8 lpf	
WATER SURFACE AREA	8' X 7'	
ROUGH-IN	12"	
MAP RATING	1,000 grams	
TRAP DIAMETER	2'	
TRAP SEAL	2-3/8'	
SHIPPING WEIGHT	Model 4987 (w/seat) - 63 lbs. (29 kg) Model 2987 - 35 lbs. (16 kg)	
WARRANTY	Vitreous China - Limited Lifetime Tank Trim & Seat - Limited Five-Year	

TECHNICAL INFORMATION

Note: these dimensions are nominal and subject to change without notice.

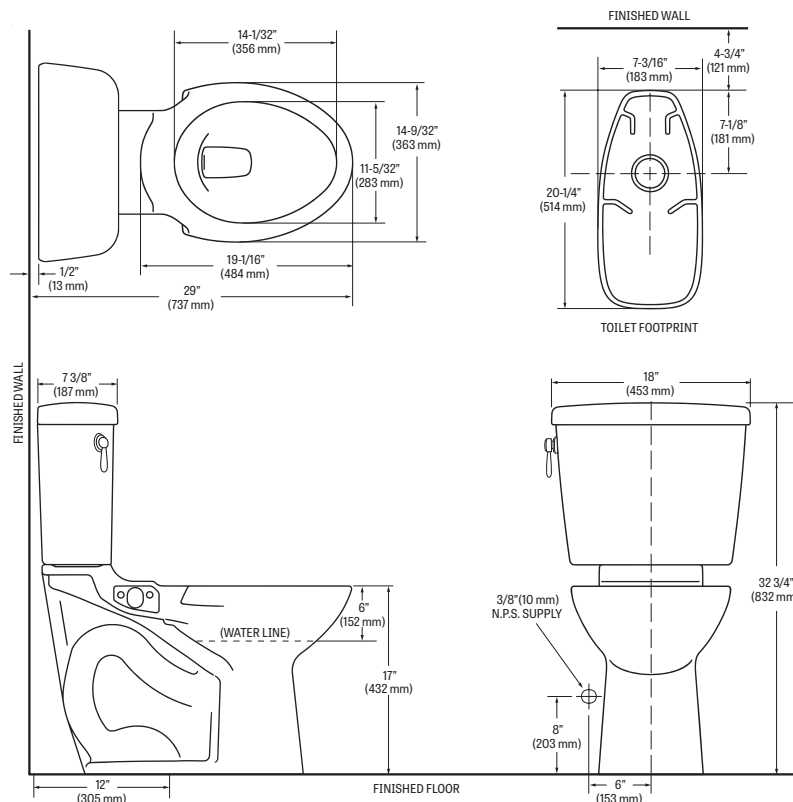

Fixture performance and specifications meet or exceed ASME A112.19.2-2013/CSA B45.1-13 standards, and other state and local codes.

