

KM 5627 208V

Electric cooktop
with a width of 36 1/8 (915) Inch for ultra-convenient cooking.

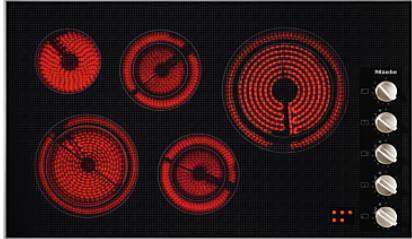

- Easy and direct controls - operation via knob controls
- Attractive design - 36 1/8 (915) Inch wide with stainless steel frame
- Versatile - 5 cooking zones
- Safe - residual heat indicator for every cooking zone

EAN: 4002514865942 / material number: 07821710

Type of heating	
Fuel type	Electrical
Construction type	
Independent of oven	•
Design	
Elegant glass ceramic surface	•
Ceramic surface color	Black
Print design	Basalt grey decor
All-round stainless steel frame	•
Proud-mounted installation	•
Ring features	
No. of rings	5
Ring	
Position	front left
Type	Variable cooking zone
Size in inches (mm)	Ø 180 / Ø 230
Max. rating in W	1600/2500
Position	rear left
Type	Single-circuit ring
Size in inches (mm)	Ø 145
Max. rating in W	1200
Position	rear center
Type	Variable cooking zone
Size in inches (mm)	120/180 mm
Max. rating in W	700/1800
Position	right
Type	Variable cooking zone
Size in inches (mm)	Ø 210 / Ø 270
Max. rating in W	2000/2700
Position	front center
Type	Variable cooking zone
Size in inches (mm)	Ø 120 / Ø 180
Max. rating in W	700/1800
Control panel	
Operation via touchpad sensors	Knob
Operation via knobs	•
Display color	Red
Extended ring area	•
Efficiency and sustainability	
Residual heat utilization	•
Cleaning convenience	
Easy to clean ceramic surface	•
Safety	
Overheating protection	•
Residual heat indicator	•

KM 5627 208V

Electric cooktop
with a width of 36 1/8 (915) Inch for ultra-convenient cooking.

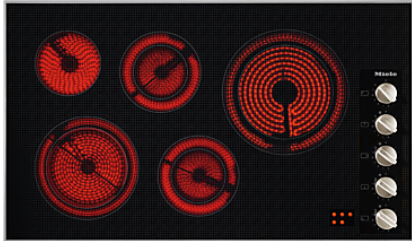

Technical data	
Dimensions in in. (width)	36 1/8 (915)
Dimensions (height) in in.(mm)	3 1/4 (81)
Built-in height with mains connection box in in.(mm)	3 (75)
Dimensions (depth) in in.(mm)	21 1/2 (544)
Cutout dimensions in in. (width) with proud-mounted installation	34 1/2 (876)
Cutout dimensions in in. (depth) with proud-mounted installation	20 1/2 (518)
Weight in lbs. (kg)	41 (19)
Total connected load in kW	10.0
Power cord length in m	4 (1.4)
Standard accessories	
Razor-blade scraper	•
Connection wire	•

KM 5627 208V

Electric cooktop
with a width of 36 1/8 (915) Inch for ultra-convenient cooking.

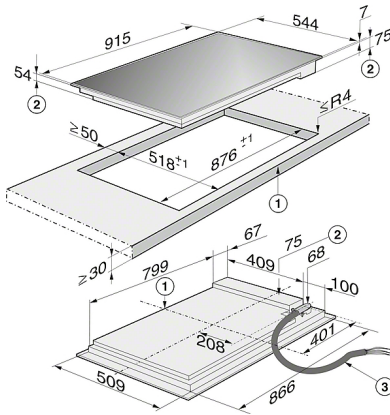
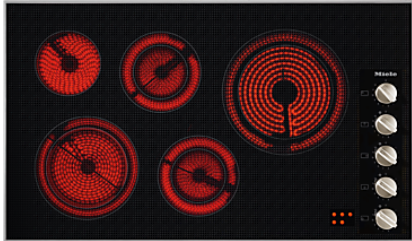

KM 5627 (Installation drawing)

1. Front
2. Building-in depth
3. Flexible metal hose, L = 1200 mm

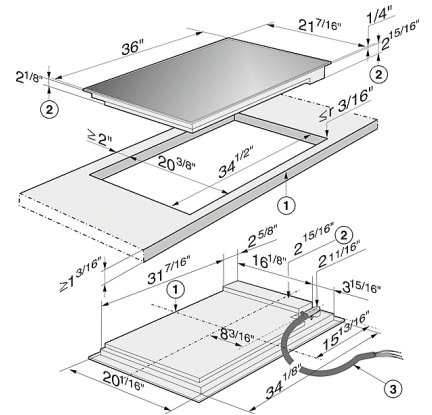

KM 5627 (Installation drawing)

1. Front
2. Building-in depth
3. Flexible metal hose, L = 47 1/4"